



**N-Channel Enhancement Mode Power MOSFET**

**Description**  
The PE8810C uses advanced trench technology to provide excellent  $R_{DS(ON)}$  and low gate charge. It can be used in a wide variety of applications. It is ESD protected.

**General Features**

- $V_{DS} = 18V, I_D = 8.5 A$   
 $R_{DS(ON)} < 13.5m\Omega @ V_{GS}=4.5V$
- $R_{DS(ON)} < 15m\Omega @ V_{GS}=3.8V$
- $R_{DS(ON)} < 16.5m\Omega @ V_{GS}=3.1V$
- $R_{DS(ON)} < 18m\Omega @ V_{GS}=2.5V$
- ESD Rating: 4000V HBM
- High Power and current handing capability
- Lead free product is acquired
- Surface Mount Package

**Application**

- PWM applications
- Load switch

**Schematic diagram**

**Marking and pin assignment**

**TSSOP-8**

**Absolute Maximum Ratings (TA=25°C unless otherwise noted)**

Parameter	Symbol	Rating	Unit
Drain-Source Voltage	$V_{DS}$	18	V
Gate-Source Voltage	$V_{GS}$	$\pm 12$	V
Drain Current-Continuous	$I_D$	8.5	A
Pulsed Drain Current (Note 1)	$I_{DM}$	32	A
Maximum Power Dissipation	$P_D$	1.5	W
Operating Junction and Storage Temperature Range	$T_J, T_{STG}$	-55 To 150	°C

**Thermal Characteristic**

Thermal Resistance, Junction-to-Ambient (Note 2)	$R_{\theta JA}$	83	°C/W
--------------------------------------------------	-----------------	----	------



**Electrical Characteristics (TA=25°C unless otherwise noted)**

Parameter	Symbol	Condition	Min	Typ	Max	Unit
<b>Off Characteristics</b>						
Drain-Source Breakdown Voltage	$BV_{DSS}$	$V_{GS}=0V, I_D=250\mu A$	-	18	-	V
Zero Gate Voltage Drain Current	$I_{DSS}$	$V_{DS}=16V, V_{GS}=0V$	-	-	1	$\mu A$
Gate-Body Leakage Current	$I_{GSS}$	$V_{GS}=\pm 10V, V_{DS}=0V$	-	-	$\pm 10$	$\mu A$
<b>On Characteristics (Note 3)</b>						
Gate Threshold Voltage	$V_{GS(th)}$	$V_{DS}=V_{GS}, I_D=250\mu A$	0.45	0.7	1.0	V
Drain-Source On-State Resistance	$R_{DS(on)}$	$V_{GS}=4.5V, I_D=7.0A$	9.5	11.5	13.5	m $\Omega$
		$V_{GS}=3.8V, I_D=6.0A$	10	12.5	15	m $\Omega$
		$V_{GS}=3.1V, I_D=5.5A$	11	13	16.5	m $\Omega$
		$V_{GS}=2.5V, I_D=5.5A$	12	14	18	m $\Omega$
Forward Transconductance	$g_{FS}$	$V_{DS}=5V, I_D=7.5A$	-	30	-	S
<b>Dynamic Characteristics (Note 4)</b>						
Input Capacitance	$C_{iss}$	$V_{DS}=10V, V_{GS}=0V,$ $F=1.0MHz$	-	850	-	pF
Output Capacitance	$C_{oss}$		-	225	-	pF
Reverse Transfer Capacitance (Note 4)	$C_{rss}$		-	205	-	pF
<b>Switching Characteristics</b>						
Turn-on Delay Time	$t_{d(on)}$	$V_{DD}=10V, R_L=1.35\Omega,$ $V_{GS}=5V, R_G=3\Omega$	-	8	-	nS
Turn-on Rise Time	$t_r$		-	17	-	nS
Turn-Off Delay Time	$t_{d(off)}$		-	60	-	nS
Turn-Off Fall Time	$t_f$		-	22	-	nS
Total Gate Charge	$Q_g$	$V_{DS}=10V, I_D=5A,$ $V_{GS}=4.5V$	-	16	-	nC
Gate-Source Charge	$Q_{gs}$		-	1.4	-	nC
Gate-Drain Charge	$Q_{gd}$		-	4.2	-	nC
<b>Drain-Source Diode Characteristics</b>						
Diode Forward Voltage (Note 3)	$V_{SD}$	$V_{GS}=0V, I_S=1A$	-	-	1.2	V

**Notes:**

1. Repetitive Rating: Pulse width limited by maximum junction temperature.
2. Surface Mounted on FR4 Board,  $t \leq 10$  sec.
3. Pulse Test: Pulse Width  $\leq 300\mu s$ , Duty Cycle  $\leq 2\%$ .
4. Guaranteed by design, not subject to product.



Typical Electrical and Thermal Characteristics

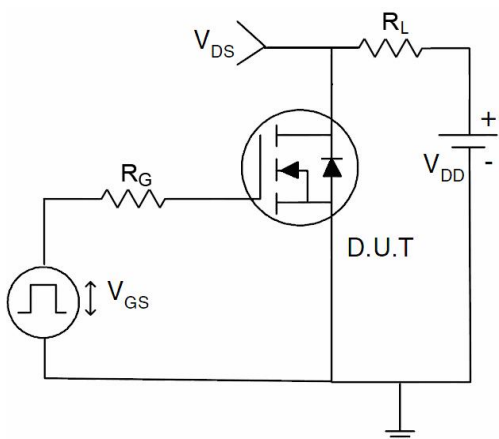

Figure 1 Switching Test Circuit

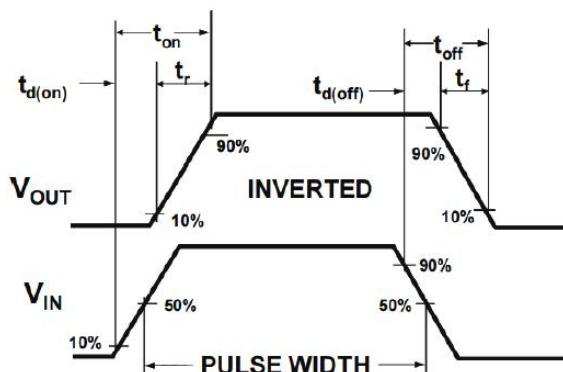

Figure 2 Switching Waveform

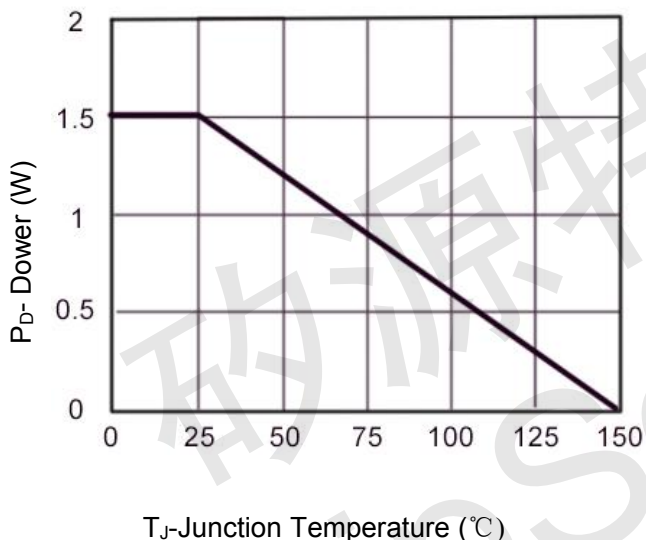

Figure 3 Power Dissipation

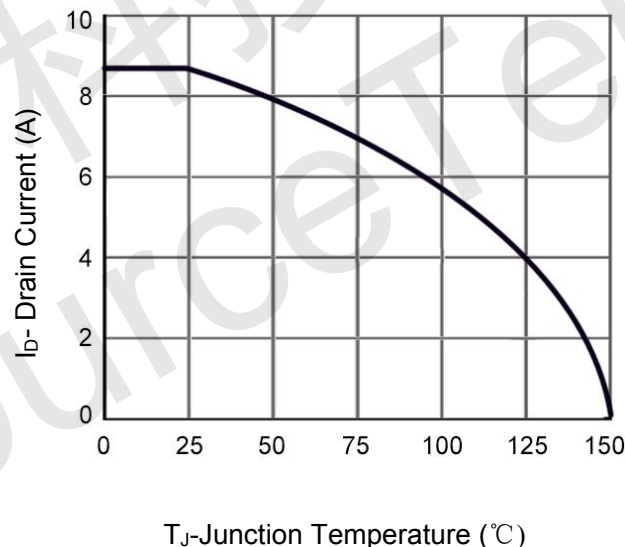

Figure 4 Drain Current

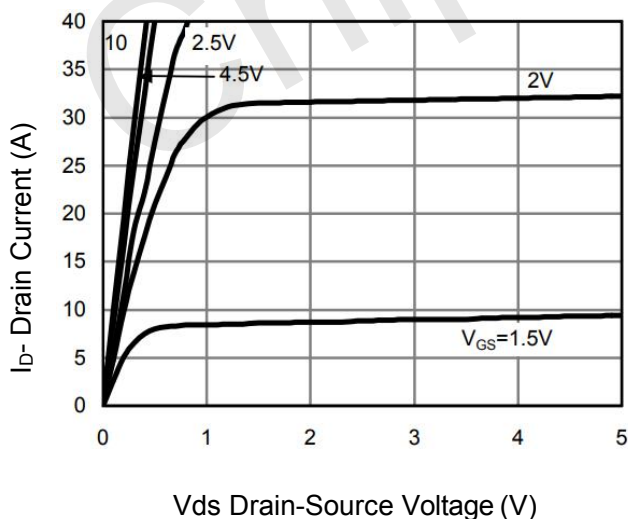

Figure 5 Output Characteristics

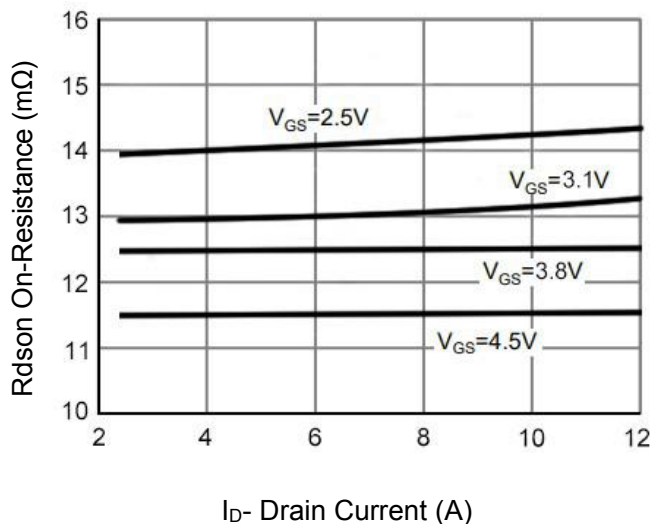

Figure 6 Rdson vs Drain Current

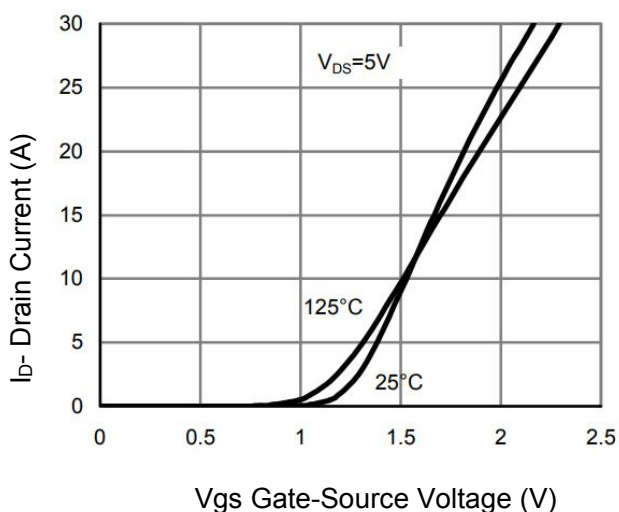

Figure 7 Transfer Characteristics

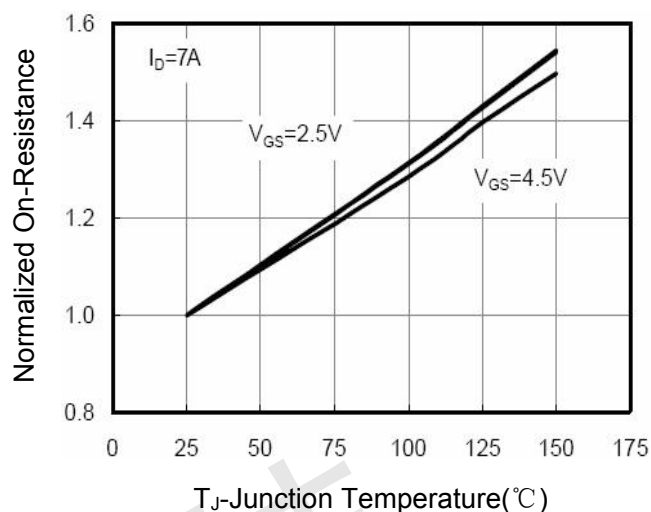

Figure 8 Rdson vs Junction Temperature

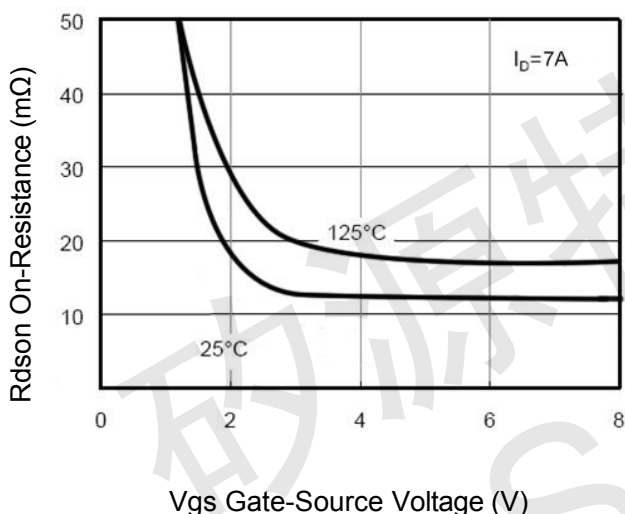

Figure 9 Rdson vs Vgs

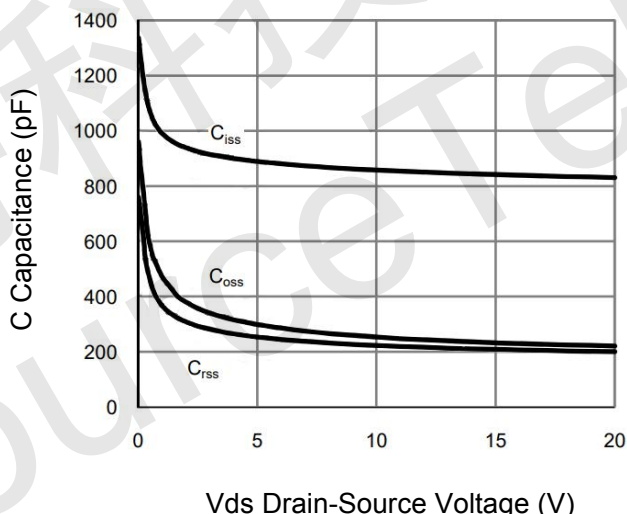

Figure 10 Capacitance vs Vds

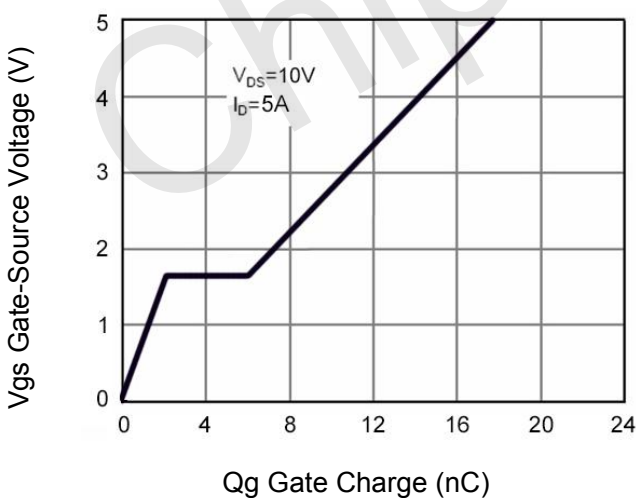

Figure 11 Gate Charge

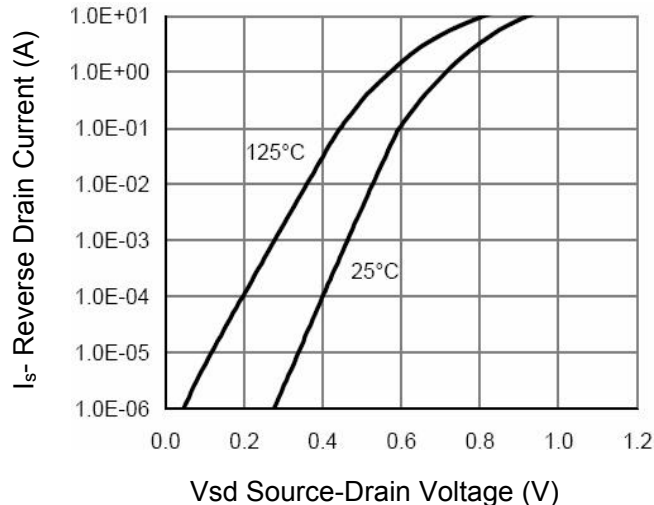

Figure 12 Source- Drain Diode Forward

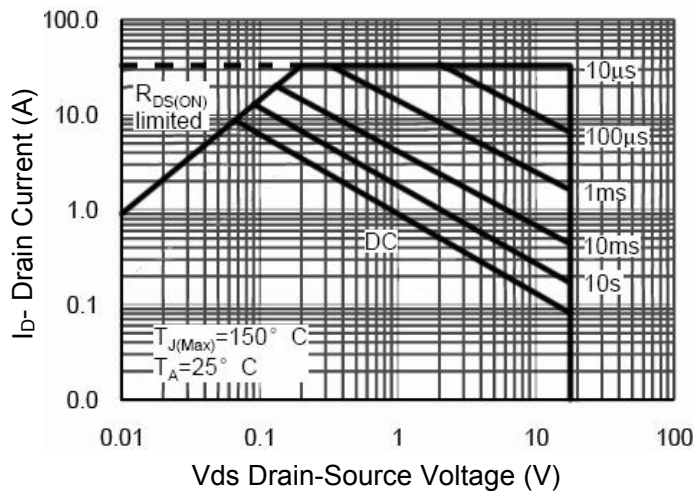

Figure 13 Safe Operation Area

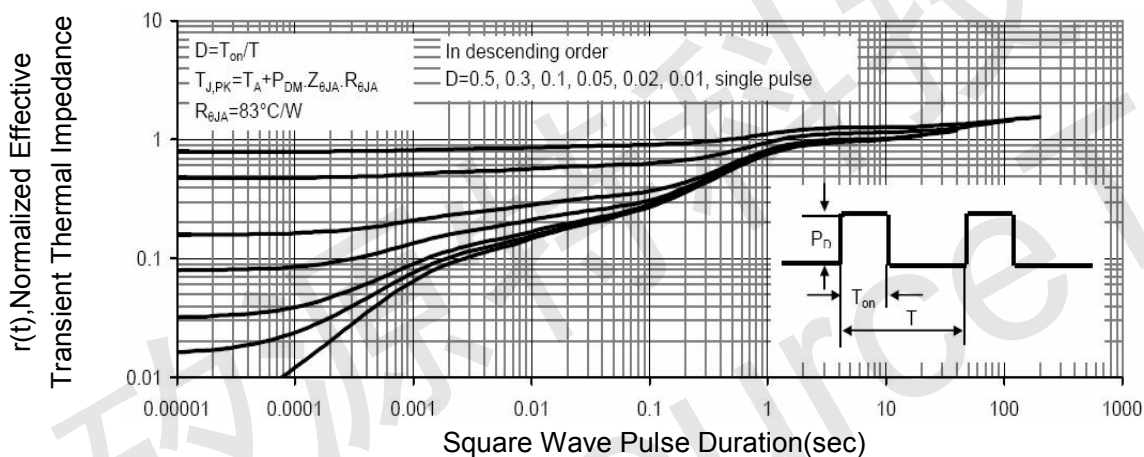
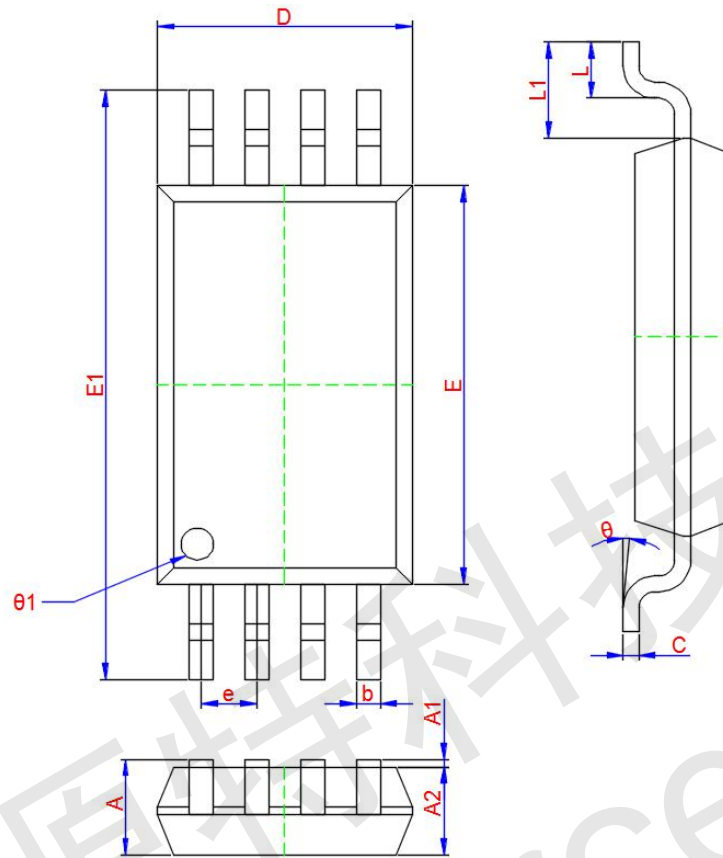

Figure 14 Normalized Maximum Transient Thermal Impedance





### TSSOP-8 Package Information



Symbol	Dimensions In Millimeters		
	Min.	Typ.	Max.
A	1.000	1.150	1.200
A1	0.020	0.100	0.180
A2	0.900	1.000	1.100
b	0.170	0.220	0.270
c	0.122	0.127	0.132
L	0.400	0.600	0.800
D	2.870	2.970	3.070
E	4.300	4.400	4.500
E1	6.200	6.400	6.600
$\theta1$	0.500	0.600	0.700
$\theta$	0°	5°	10°
L1	1.00TYP		
e	0.65TYP		