



**P-Channel Enhancement Mode Power MOSFET**

**Description**

The PE7170G uses advanced trench technology to provide excellent  $R_{DS(ON)}$  and low gate charge. It can be used in a wide variety of applications.

**General Features**

- $V_{DS} = -18V$ ,  $I_D = -70A$

$R_{DS(ON)} < 3.5m\Omega @ V_{GS}=-4.5V$

$R_{DS(ON)} < 5m\Omega @ V_{GS}=-2.5V$

- High Power and current handing capability
- Lead free product is acquired
- Surface Mount Package

**Application**

- PWM applications
- Load switch
- Power management

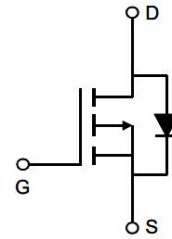

Schematic diagram

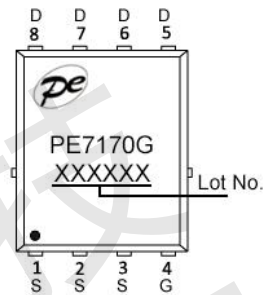

Marking and pin assignment

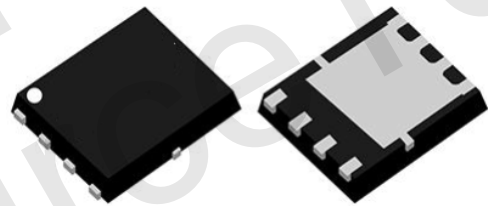

DFN5x6-8L

**Absolute Maximum Ratings (TC=25°C unless otherwise noted)**

Parameter	Symbol	Rating	Unit
Drain-Source Voltage	$V_{DS}$	-18	V
Gate-Source Voltage	$V_{GS}$	$\pm 12$	V
Drain Current-Continuous (TC=25°C)	$I_D$	-70	A
Drain Current-Continuous (TC=70°C)	$I_D$	-56	A
Maximum Power Dissipation (TC=25°C)	$P_D$	138	W
Pulsed Drain Current (Note 1)	$I_{DM}$	-280	A
Drain Current-Continuous (TA=25°C)	$I_D$	-38	A
Drain Current-Continuous (TA=70°C)	$I_D$	-30	A
Maximum Power Dissipation (TA=25°C)	$P_D$	4.5	W
Avalanche Current	$I_{AS}$	68	A
Avalanche Energy (L=0.1mH)	$E_{AS}$	231	mJ
Operating Junction and Storage Temperature Range	$T_J, T_{STG}$	-55 To 150	°C

**Thermal Characteristic**

Thermal Resistance, Junction-to-Case	$R_{\theta JC}$	0.91	°C/W
Thermal Resistance, Junction-to-Ambient	$R_{\theta JA}$	27.8	°C/W



**Electrical Characteristics (TC=25°C unless otherwise noted)**

Parameter	Symbol	Condition	Min	Typ	Max	Unit
<b>Off Characteristics</b>						
Drain-Source Breakdown Voltage	$BV_{DSS}$	$V_{GS}=0V, I_D=-250\mu A$	-	-18	-	V
Zero Gate Voltage Drain Current	$I_{DSS}$	$V_{DS}=-12V, V_{GS}=0V$	-	-	-1	$\mu A$
Gate-Body Leakage Current	$I_{GSS}$	$V_{GS}=\pm 10V, V_{DS}=0V$	-	-	$\pm 100$	nA
<b>On Characteristics (Note 3)</b>						
Gate Threshold Voltage	$V_{GS(th)}$	$V_{DS}=V_{GS}, I_D=-250\mu A$	-0.45	-0.7	-1	V
Drain-Source On-State Resistance	$R_{DS(on)}$	$V_{GS}=-4.5V, I_D=-20A$	-	2.6	3.5	m $\Omega$
		$V_{GS}=-2.5V, I_D=-15A$	-	3.4	5	m $\Omega$
Forward Transconductance	$g_{FS}$	$V_{DS}=-5V, I_D=-15A$	-	105	-	S
<b>Dynamic Characteristics (Note 3)</b>						
Input Capacitance	$C_{iss}$	$V_{DS}=-10V, V_{GS}=0V,$ $F=1.0MHz$	-	8100	-	pF
Output Capacitance	$C_{oss}$		-	2150	-	pF
Reverse Transfer Capacitance (Note 4)	$C_{rss}$		-	1160	-	pF
<b>Switching Characteristics</b>						
Turn-on Delay Time	$t_{d(on)}$	$V_{DD}=-10V, R_L=1\Omega,$ $V_{GS}=-10V, R_G=3\Omega$	-	9	-	nS
Turn-on Rise Time	$t_r$		-	18	-	nS
Turn-Off Delay Time	$t_{d(off)}$		-	285	-	nS
Turn-Off Fall Time	$t_f$		-	90	-	nS
Total Gate Charge	$Q_g$	$V_{DS}=-10V, I_D=-20A,$ $V_{GS}=-10V$	-	187	-	nC
Gate-Source Charge	$Q_{gs}$		-	17	-	nC
Gate-Drain Charge	$Q_{gd}$		-	28	-	nC
<b>Drain-Source Diode Characteristics</b>						
Diode Forward Voltage (Note 3)	$V_{SD}$	$V_{GS}=0V, I_S=-1A$	-	-	-1	V
Diode Forward Current (Note 2)	$I_S$		-	-	-70	A

**Notes:**

1. Repetitive Rating: Pulse width limited by maximum junction temperature.
2. Surface Mounted on FR4 Board,  $t \leq 10$  sec.
3. Pulse Test: Pulse Width  $\leq 300\mu s$ , Duty Cycle  $\leq 2\%$ .
4. Guaranteed by design, not subject to product.



Typical Electrical and Thermal Characteristics

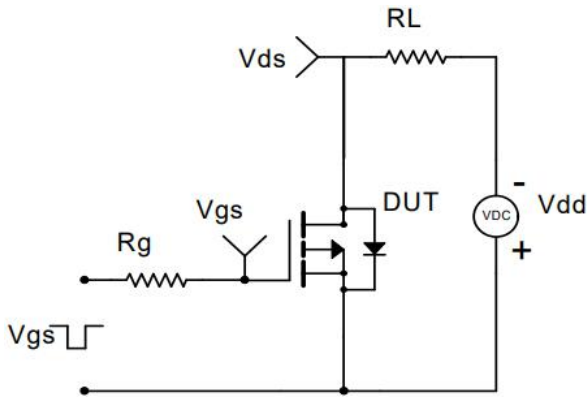

Figure 1 Switching Test Circuit

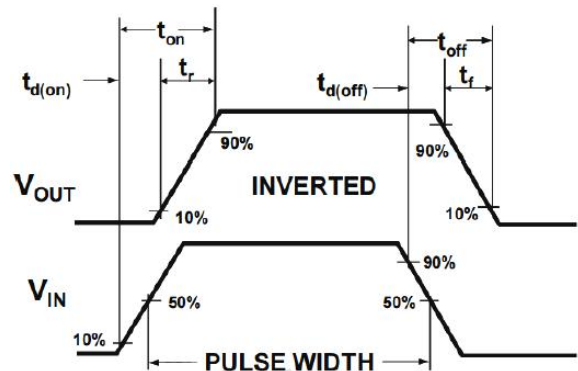

Figure 2 Switching Waveform

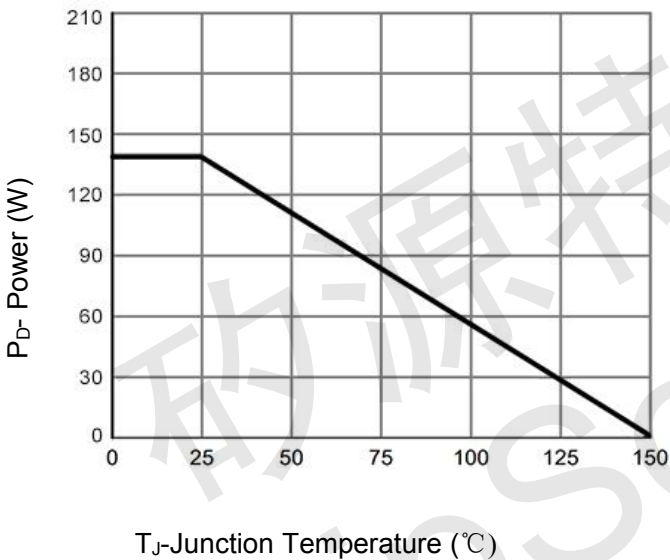

Figure 3 Power De-rating

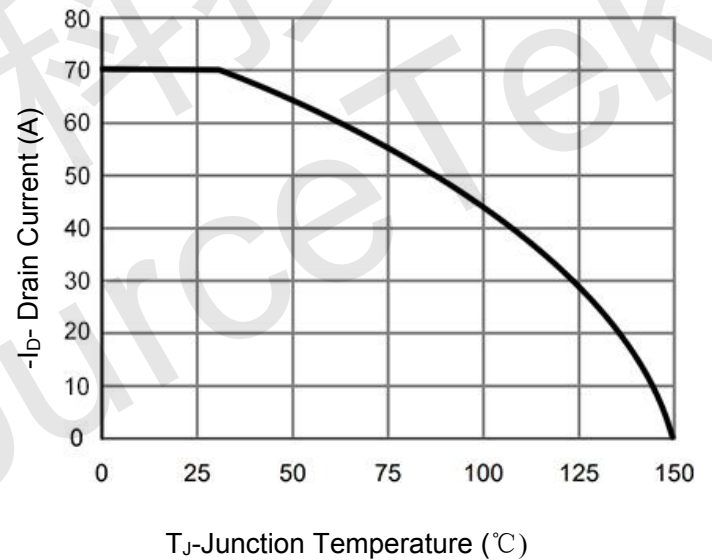

Figure 4 Drain Current

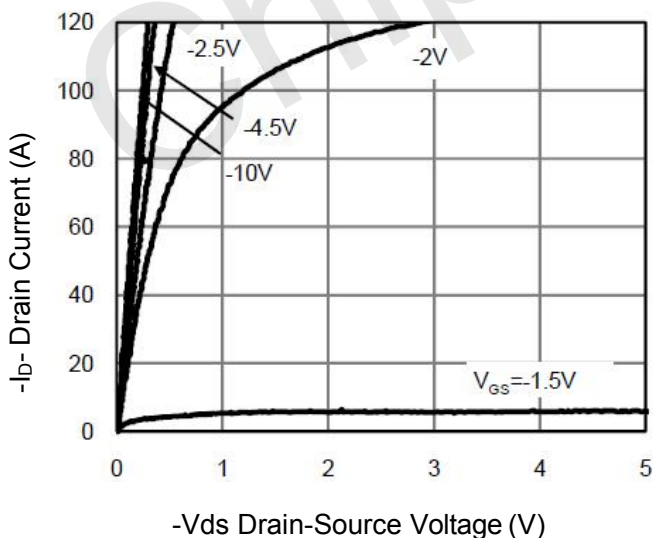

Figure 5 Output Characteristics

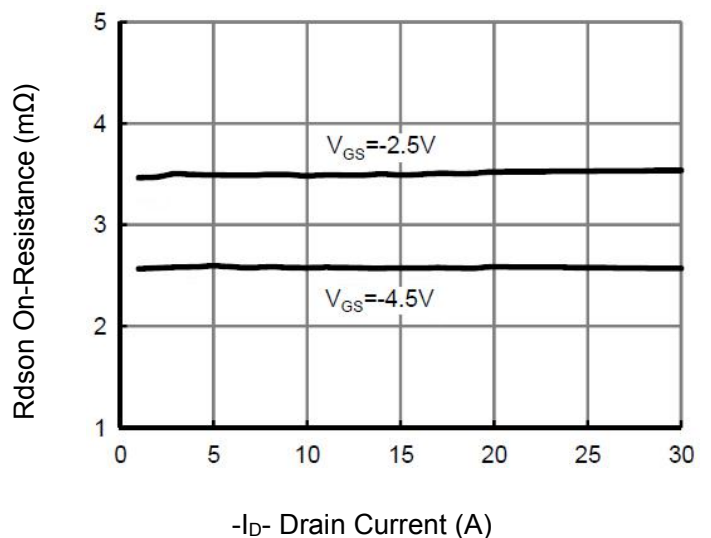
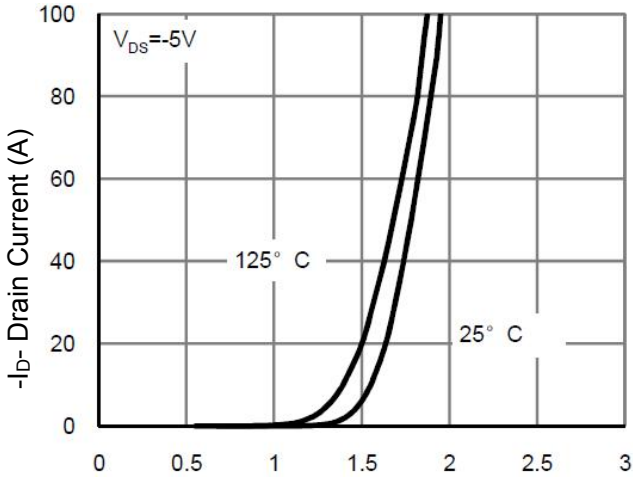
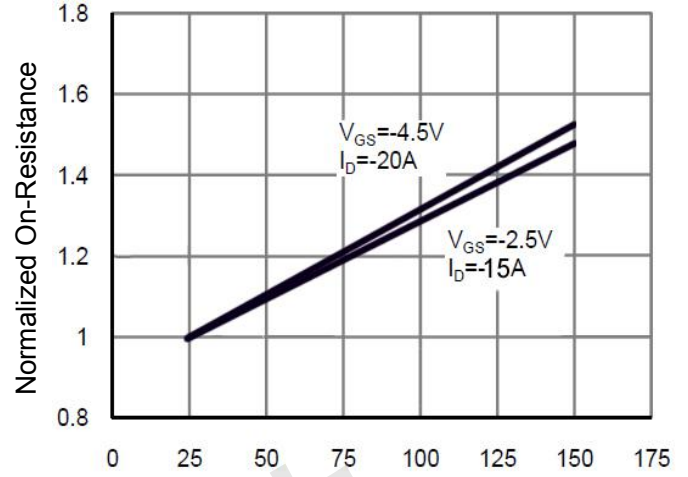

Figure 6 Rdson vs Drain Current



-Vgs Gate-Source Voltage (V)

Figure 7 Transfer Characteristics



TJ-Junction Temperature(°C)

Figure 8 Rdson vs Junction Temperature

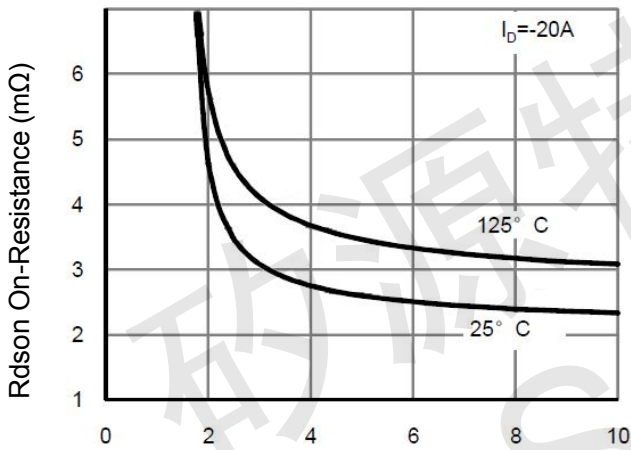

-Vgs Gate-Source Voltage (V)

Figure 9 Rdson vs Vgs

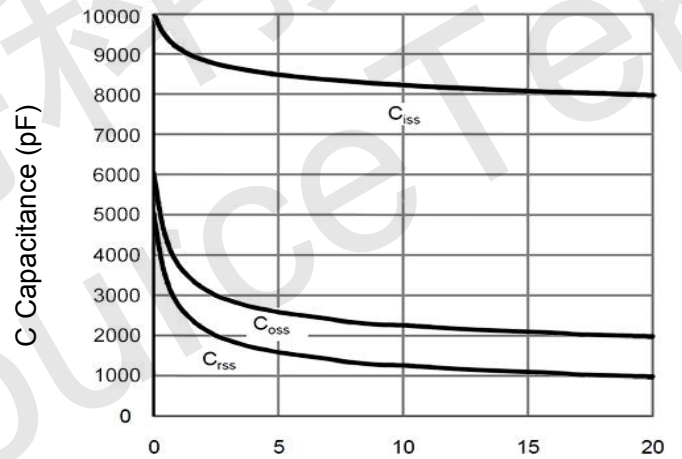

-Vds Drain-Source Voltage (V)

Figure 10 Capacitance vs Vds

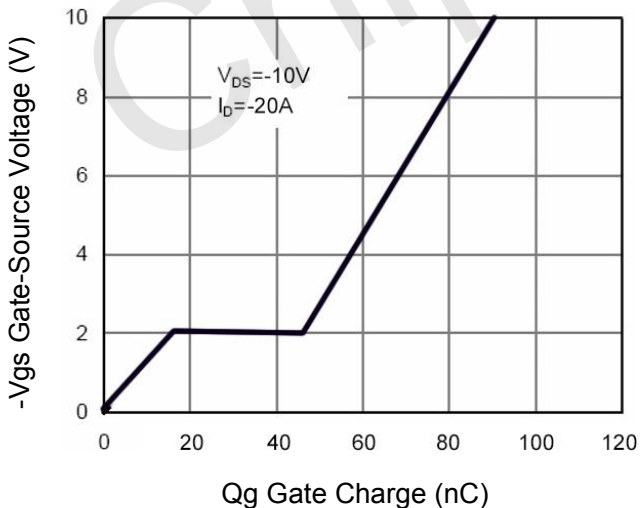

Qg Gate Charge (nC)

Figure 11 Gate Charge

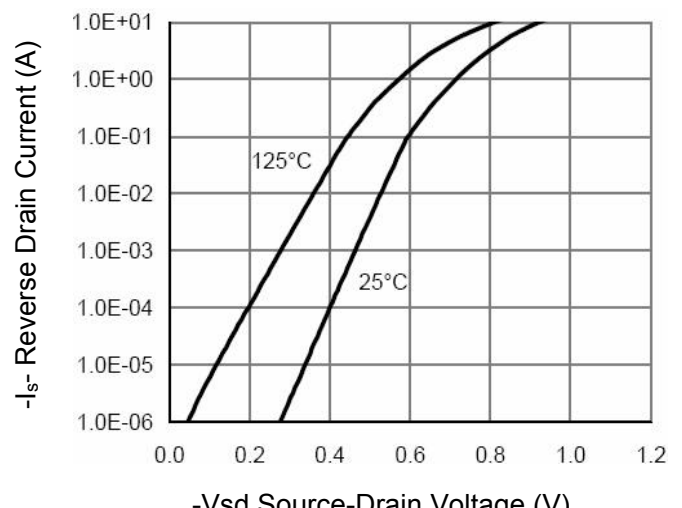

-Vsd Source-Drain Voltage (V)

Figure 12 Source- Drain Diode Forward

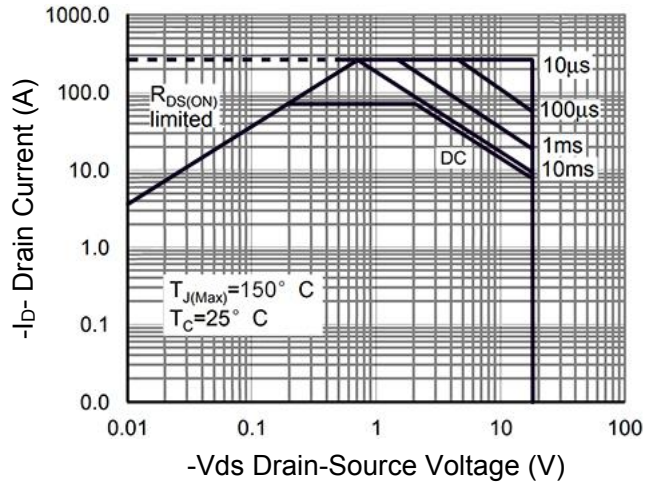

Figure 13 Safe Operation Area

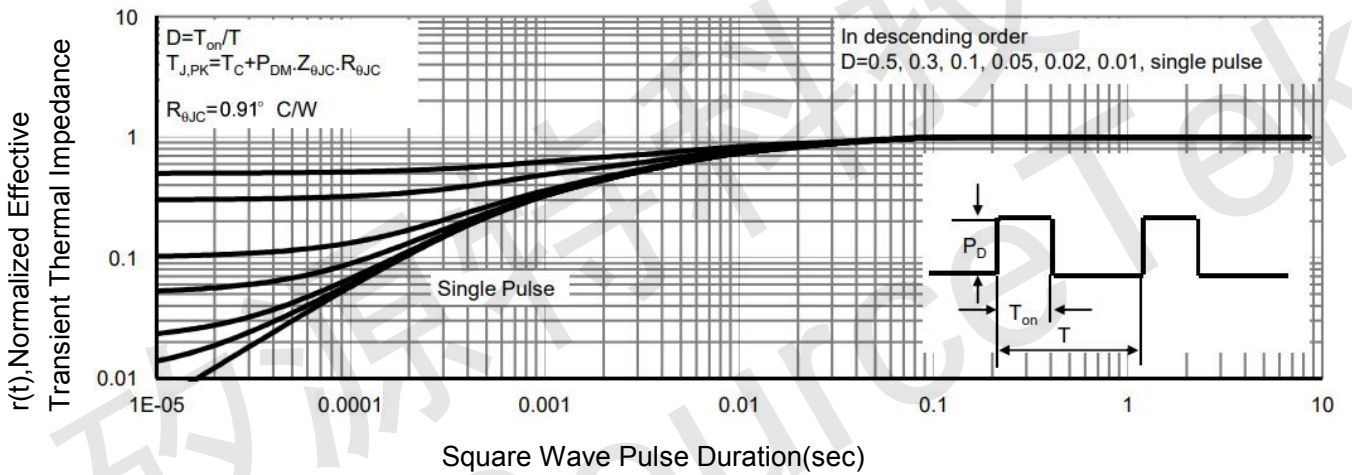
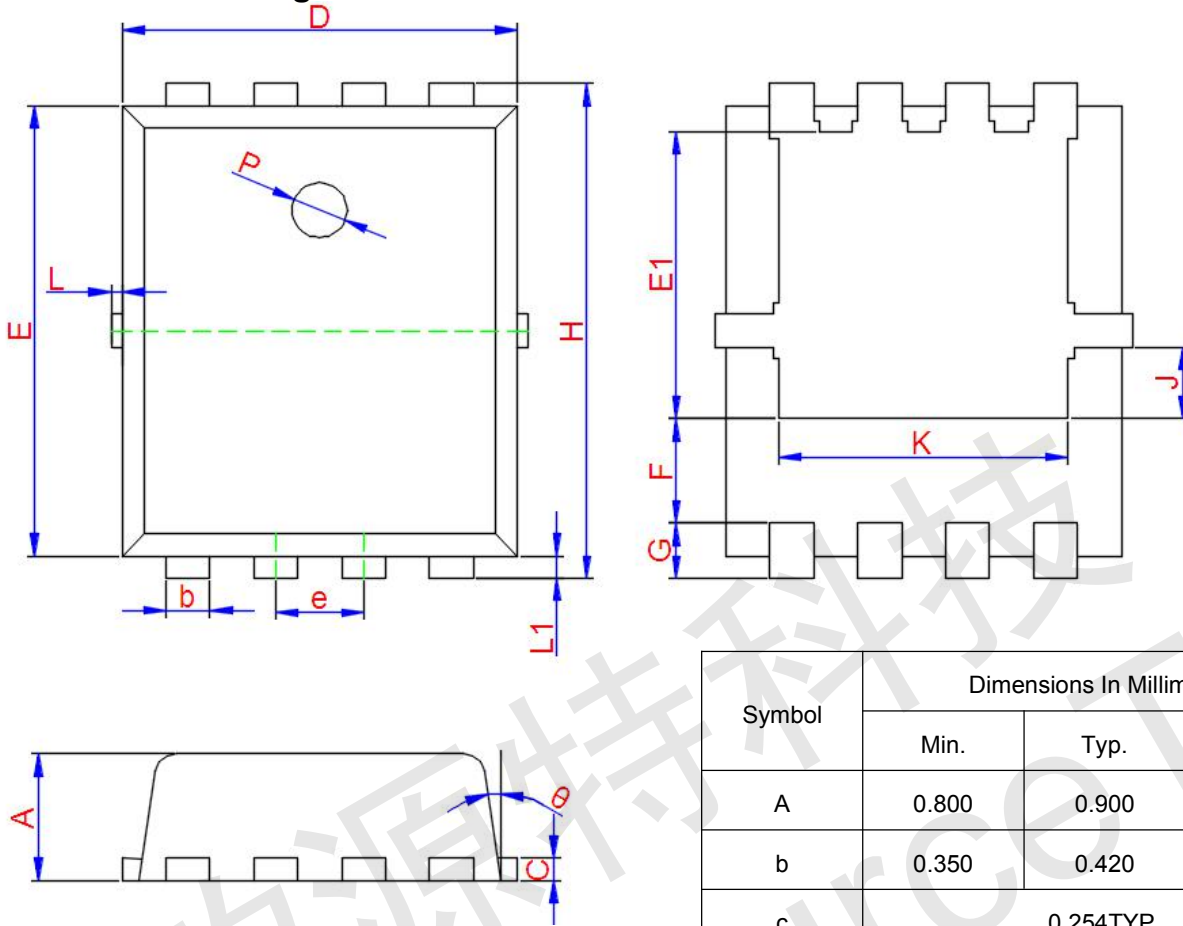

Figure 14 Normalized Maximum Transient Thermal Impedance



**DFN5x6-8L Package Information**



Symbol	Dimensions In Millimeters		
	Min.	Typ.	Max.
A	0.800	0.900	1.000
b	0.350	0.420	0.490
c	0.254TYP.		
D	4.900	5.000	5.100
e	1.270TYP.		
E	5.700	5.800	5.900
E1	3.400TYP.		
F	1.400TYP.		
G	0.600TYP.		
H	5.950	6.080	6.200
J	0.950TYP.		
K	4.000TYP.		
L	-	-	0.150
L1	0.100	0.140	0.180
P	1.000TYP.		
θ	6°	10°	14°