



P-Channel Enhancement Mode Power MOSFET

Description

The PE3117F uses advanced trench technology to provide excellent $R_{DS(ON)}$ and low gate charge. It can be used in a wide variety of applications. It is ESD protected.

General Features

- $V_{DS} = -30V$, $I_D = -9.5A$

$R_{DS(ON)} < 22m\Omega @ V_{GS} = -10V$

$R_{DS(ON)} < 32m\Omega @ V_{GS} = -4.5V$

ESD Rating: $\geq 4000V$ HBM

- High Power and current handing capability
- Lead free product is acquired
- Surface Mount Package

Application

- PWM applications
- Load switch
- Power management

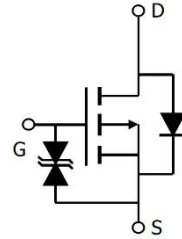

Schematic diagram

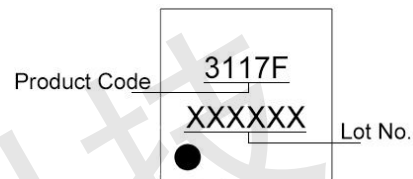

Marking and pin assignment

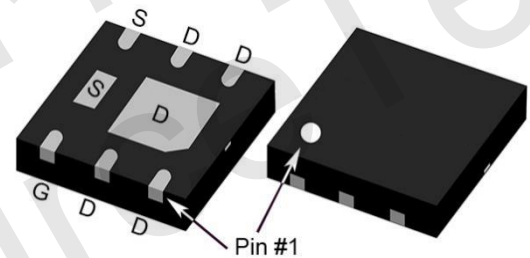

UDFN2x2-6L

Absolute Maximum Ratings (TA=25°C unless otherwise noted)

Parameter	Symbol	Rating	Unit
Drain-Source Voltage	V_{DS}	-30	V
Gate-Source Voltage	V_{GS}	± 20	V
Drain Current-Continuous	I_D	-9.5	A
Drain Current-Continuous (TA=70°C)	I_D	-7	A
Pulsed Drain Current (Note 1)	I_{DM}	-38	A
Maximum Power Dissipation	P_D	2.8	W
Operating Junction and Storage Temperature Range	T_J, T_{STG}	-55 To 150	°C

Thermal Characteristic

Thermal Resistance, Junction-to-Ambient (Note 2)	$R_{\theta JA}$	45	°C/W
--	-----------------	----	------



Electrical Characteristics (TA=25°C unless otherwise noted)

Parameter	Symbol	Condition	Min	Typ	Max	Unit
Off Characteristics						
Drain-Source Breakdown Voltage	BV_{DSS}	$V_{GS}=0V, I_D=-250\mu A$	-30	-	-	V
Zero Gate Voltage Drain Current	I_{DSS}	$V_{DS}=-30V, V_{GS}=0V$	-	-	1	μA
Gate-Body Leakage Current	I_{GSS}	$V_{GS}=-20V/+15V, V_{DS}=0V$	-	-	± 10	μA
On Characteristics (Note 3)						
Gate Threshold Voltage	$V_{GS(th)}$	$V_{DS}=V_{GS}, I_D=-250\mu A$	-0.9	-1.5	-2.1	V
Drain-Source On-State Resistance	$R_{DS(on)}$	$V_{GS}=-10V, I_D=-4.5A$	-	17	22	m Ω
		$V_{GS}=-4.5V, I_D=-4A$	-	23	32	m Ω
Forward Transconductance	g_{FS}	$V_{DS}=-10V, I_D=-4.1A$	-	20	-	S
Dynamic Characteristics (Note 4)						
Input Capacitance	C_{iss}	$V_{DS}=-15V, V_{GS}=0V, F=10KHz$	-	235	-	pF
Output Capacitance	C_{oss}		-	180	-	pF
Reverse Transfer Capacitance (Note 4)	C_{rss}		-	25	-	pF
Gate Resistance	R_g		-	5	-	k Ω
Switching Characteristics						
Turn-on Delay Time	$t_{d(on)}$	$V_{DS}=-15V, R_L=1\Omega, V_{GS}=-10V, R_G=3\Omega$	-	9	-	nS
Turn-on Rise Time	t_r		-	5	-	nS
Turn-Off Delay Time	$t_{d(off)}$		-	28	-	nS
Turn-Off Fall Time	t_f		-	13.8	-	nS
Total Gate Charge	Q_g	$V_{DS}=-15V, I_D=-4A, V_{GS}=-10V$	-	22	-	nC
Gate-Source Charge	Q_{gs}		-	3	-	nC
Gate-Drain Charge	Q_{gd}		-	7	-	nC
Drain-Source Diode Characteristics						
Diode Forward Voltage (Note 3)	V_{SD}	$V_{GS}=0V, I_S=-1A$	-	-	-1.2	V
Diode Forward Current (Note 2)	I_S		-	-	-5	A

Notes:

1. Repetitive Rating: Pulse width limited by maximum junction temperature.
2. Surface Mounted on FR4 Board, $t \leq 10$ sec.
3. Pulse Test: Pulse Width $\leq 300\mu s$, Duty Cycle $\leq 2\%$.
4. Guaranteed by design, not subject to product.



Typical Electrical and Thermal Characteristics

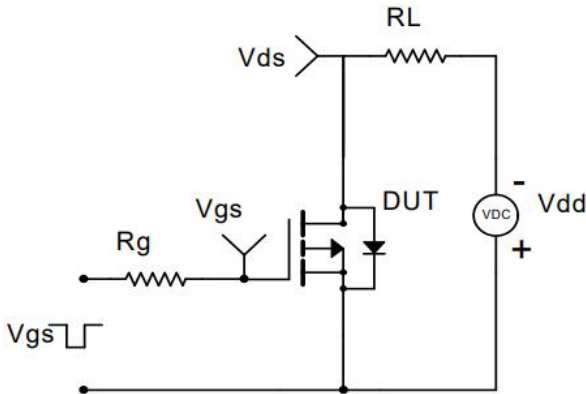

Figure 1 Switching Test Circuit

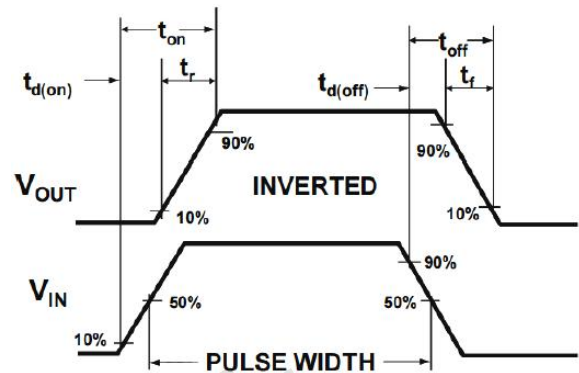

Figure 2 Switching Waveform

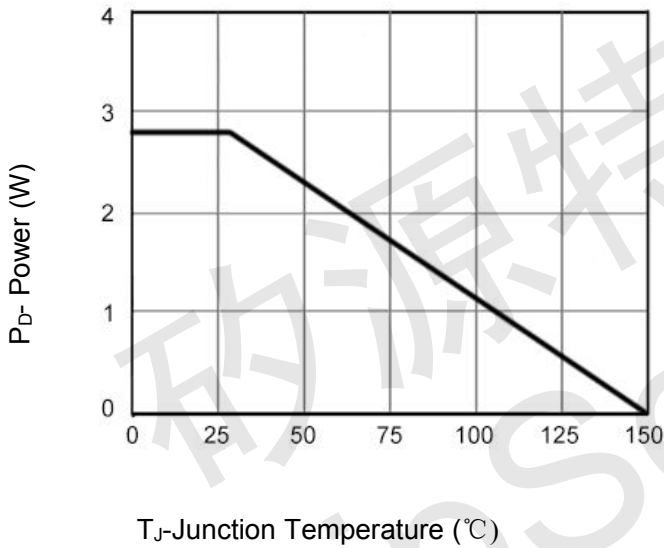

Figure 3 Power De-rating

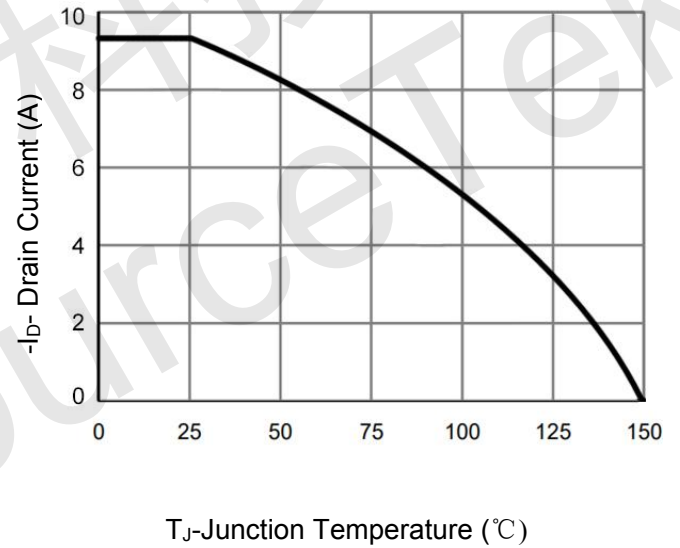

Figure 4 Drain Current

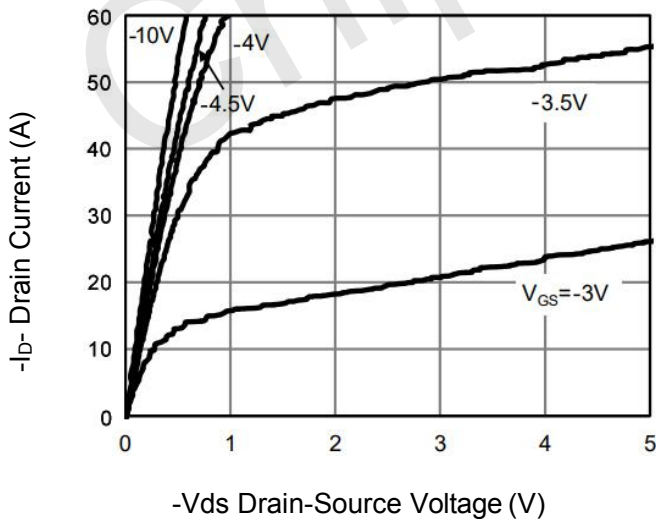

Figure 5 Output Characteristics

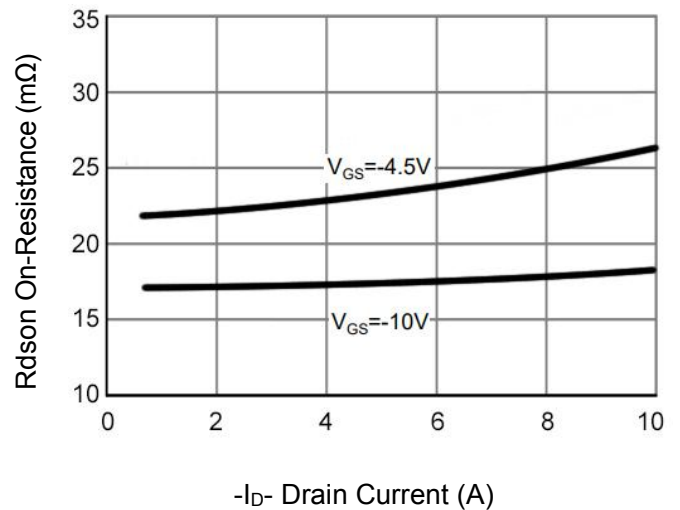
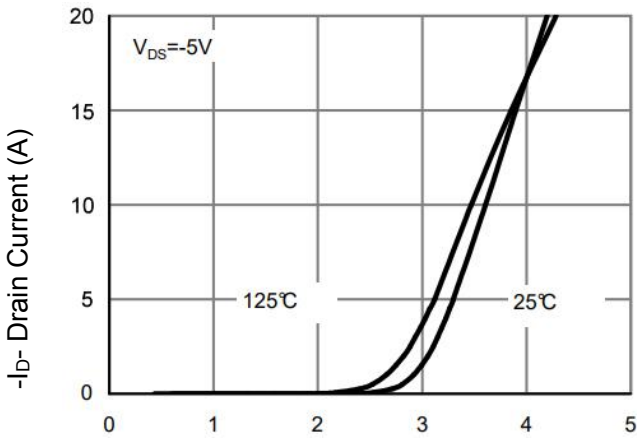
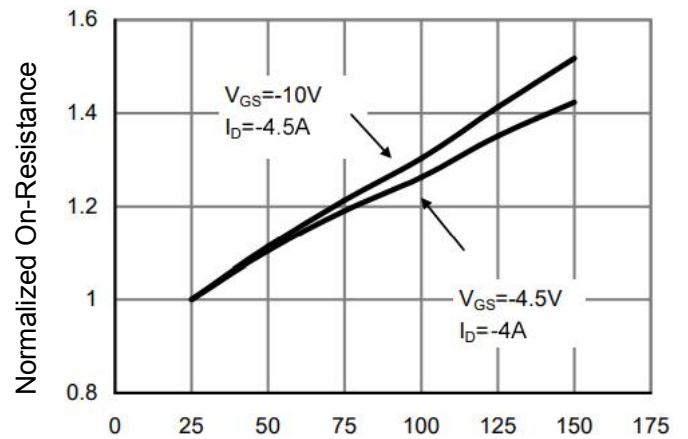

Figure 6 Rdson vs Drain Current



-Vgs Gate-Source Voltage (V)

Figure 7 Transfer Characteristics



TJ-Junction Temperature(°C)

Figure 8 Rdson vs Junction Temperature

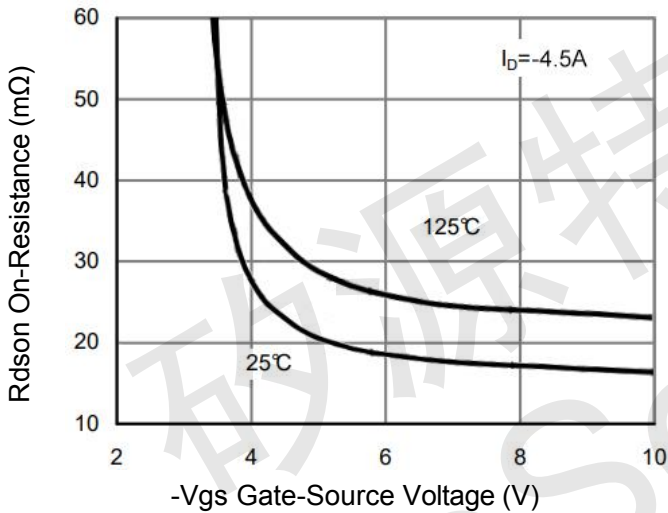

-Vgs Gate-Source Voltage (V)

Figure 9 Rdson vs Vgs

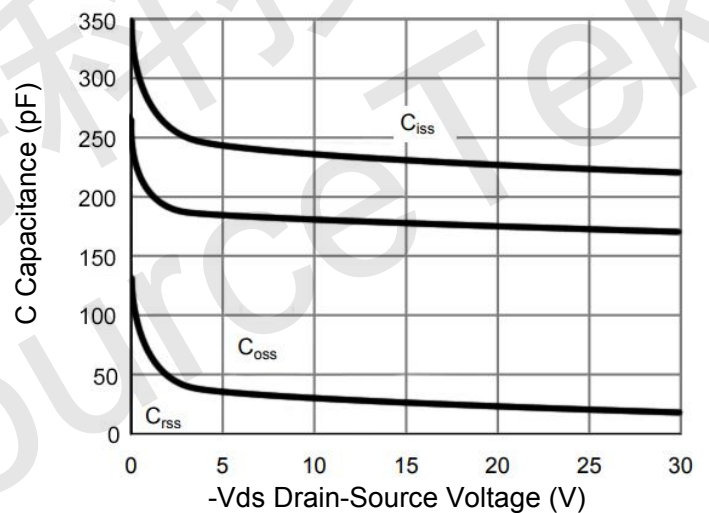

Figure 10 Capacitance vs Vds

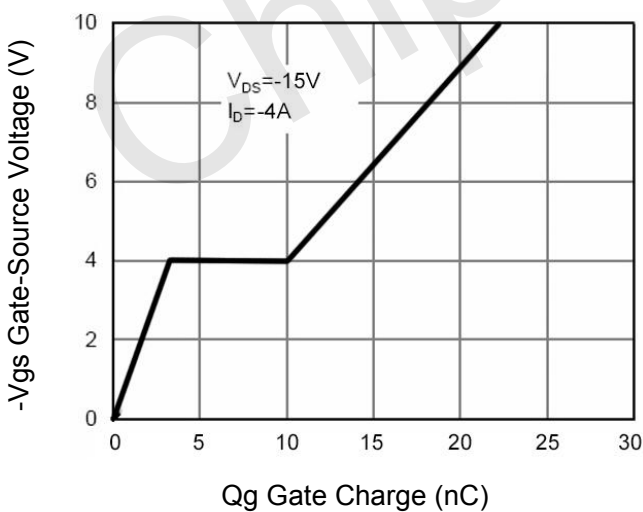

Figure 11 Gate Charge

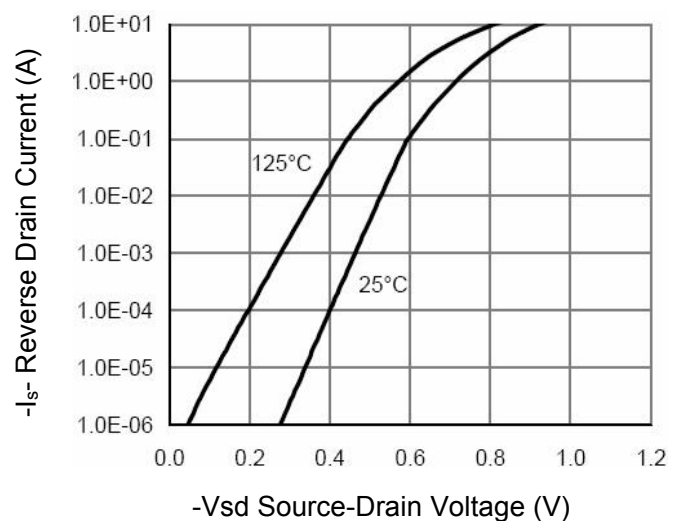

Figure 12 Source- Drain Diode Forward

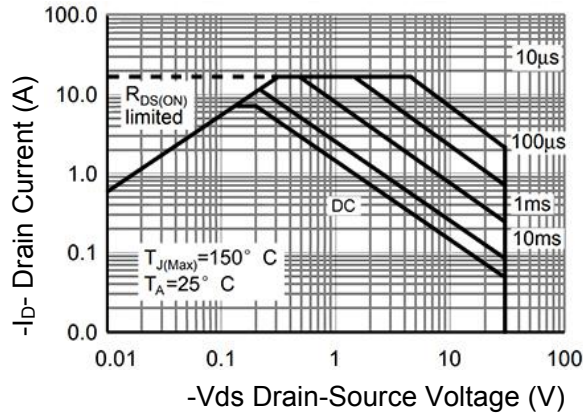

Figure 13 Safe Operation Area

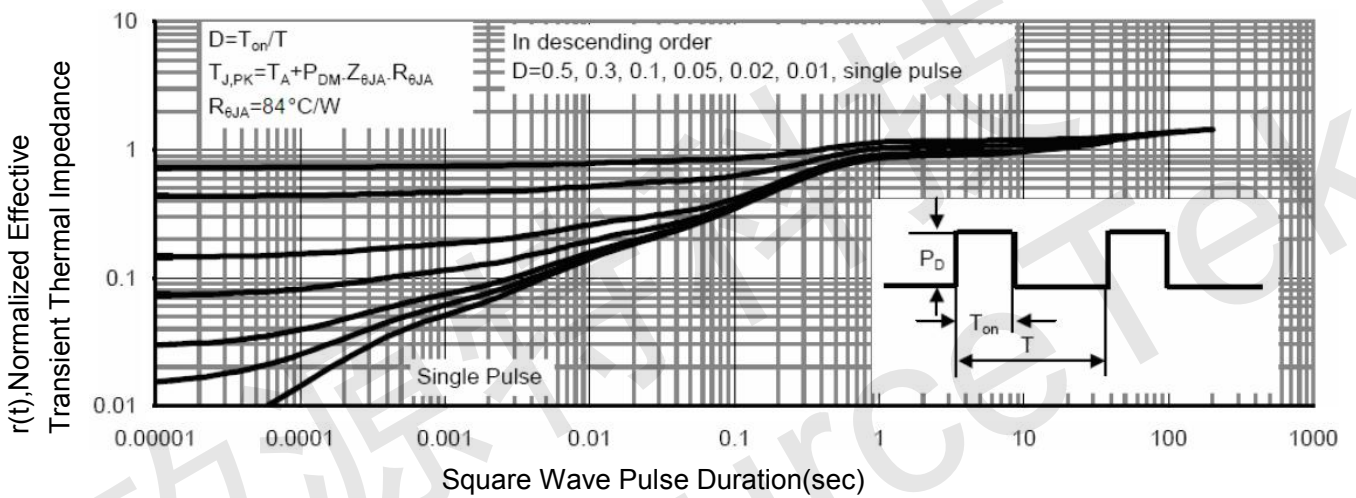
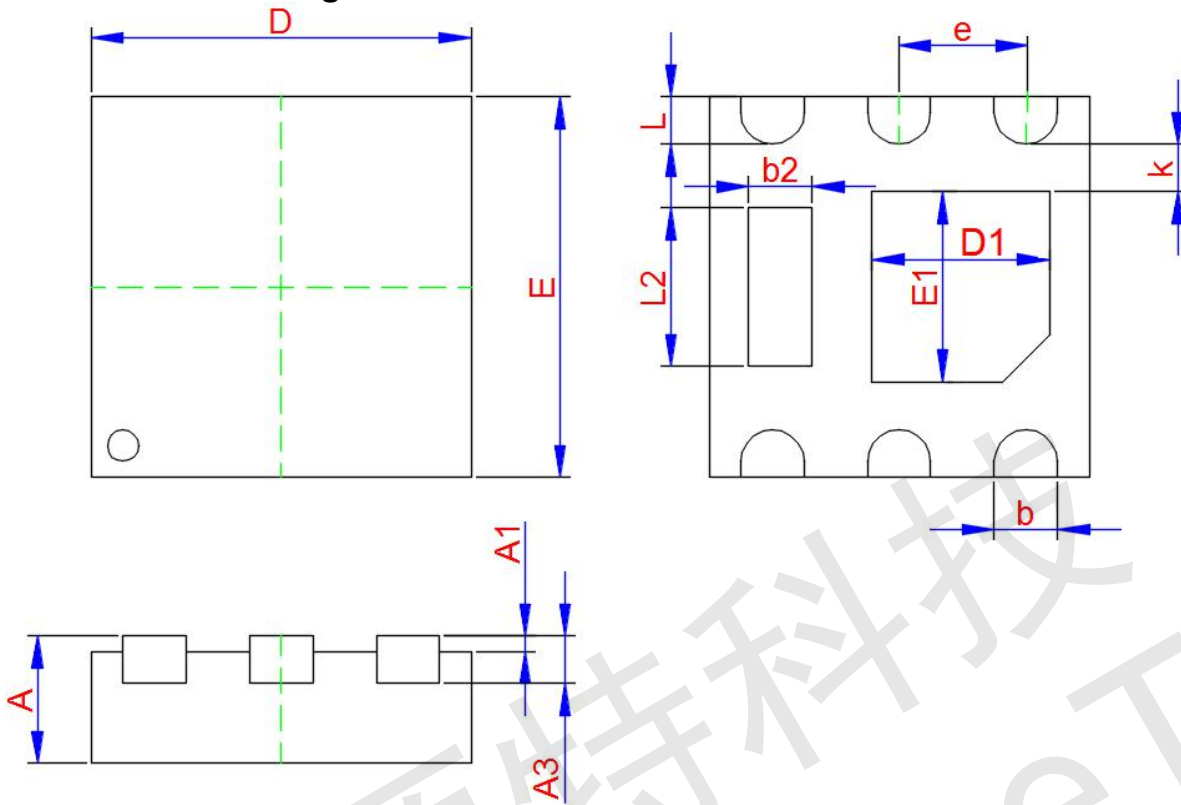

Figure 14 Normalized Maximum Transient Thermal Impedance



UDFN2X2-6L Package Information



Symbol	Dimensions In Millimeters		
	Min.	Typ.	Max.
A	0.450	0.500	0.550
A1	0.000	-	0.050
A3	0.120	0.150	0.190
D	1.950	2.000	2.050
E	1.950	2.000	2.050
D1	0.970	1.000	1.030
E1	0.970	1.000	1.030
b	0.250	0.300	0.350
L	0.200	0.250	0.300
b2	0.250	0.300	0.350
L2	0.750	0.800	0.850
k	0.250MIN.		
e	0.650TYP.		