



N-Channel Enhancement Mode Power MOSFET

Description

The PE30D10 uses advanced trench technology to provide excellent $R_{DS(ON)}$ and low gate charge. It can be used in a wide variety of applications.

General Features

- $V_{DS} = 30V$, $I_D = 10A$
- $R_{DS(ON)} < 13m\Omega @ V_{GS}=10V$
- $R_{DS(ON)} < 18m\Omega @ V_{GS}=4.5V$
- High Power and current handing capability
- Lead free product is acquired
- Surface Mount Package

Application

- PWM applications
- Load switch
- Power management

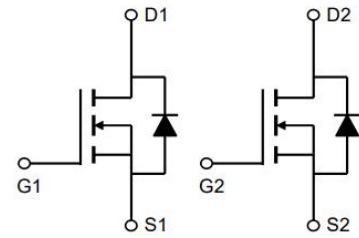

Schematic diagram

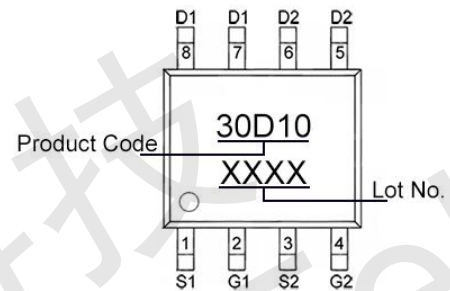

Marking and pin assignment

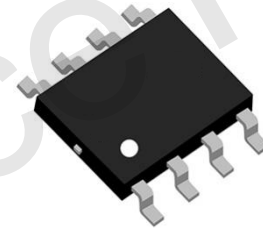

SOP-8

Absolute Maximum Ratings (TA=25°C unless otherwise noted)

Parameter	Symbol	Rating	Unit
Drain-Source Voltage	V_{DS}	30	V
Gate-Source Voltage	V_{GS}	± 20	V
Drain Current-Continuous	I_D	10	A
Drain Current-Continuous (TA=70°C)	I_D	7	A
Pulsed Drain Current (Note 1)	I_{DM}	28	A
Maximum Power Dissipation	P_D	2	W
Operating Junction and Storage Temperature Range	T_J, T_{STG}	-55 To 150	°C

Thermal Characteristic

Thermal Resistance, Junction-to-Ambient (Note 2)	$R_{\theta JA}$	62.5	°C/W
--	-----------------	------	------



Electrical Characteristics (TA=25°C unless otherwise noted)

Parameter	Symbol	Condition	Min	Typ	Max	Unit
Off Characteristics						
Drain-Source Breakdown Voltage	BV_{DSS}	$V_{GS}=0V, I_D=250\mu A$	30	-	-	V
Zero Gate Voltage Drain Current	I_{DSS}	$V_{DS}=30V, V_{GS}=0V$	-	-	1	μA
Gate-Body Leakage Current	I_{GSS}	$V_{GS}=\pm 20V, V_{DS}=0V$	-	-	± 100	nA
On Characteristics (Note 3)						
Gate Threshold Voltage	$V_{GS(th)}$	$V_{DS}=V_{GS}, I_D=250\mu A$	1	1.7	2.5	V
Drain-Source On-State Resistance	$R_{DS(on)}$	$V_{GS}=10V, I_D=8A$	-	11	13	m Ω
		$V_{GS}=4.5V, I_D=6A$	-	16	18	m Ω
Forward Transconductance	g_{FS}	$V_{DS}=5V, I_D=8A$	-	24	-	S
Dynamic Characteristics (Note 4)						
Input Capacitance	C_{iss}	$V_{DS}=15V, V_{GS}=0V,$ $F=1.0MHz$	-	840	-	pF
Output Capacitance	C_{oss}		-	120	-	pF
Reverse Transfer Capacitance (Note 4)	C_{rss}		-	85	-	pF
Switching Characteristics						
Turn-on Delay Time	$t_{d(on)}$	$V_{DD}=15V, I_D=2A, R_L=1\Omega,$ $V_{GS}=10V, R_G=3\Omega$	-	4.2	-	nS
Turn-on Rise Time	t_r		-	8.2	-	nS
Turn-Off Delay Time	$t_{d(off)}$		-	31	-	nS
Turn-Off Fall Time	t_f		-	4	-	nS
Total Gate Charge	Q_g	$V_{DS}=15V, I_D=6A,$ $V_{GS}=10V$	-	14	-	nC
Gate-Source Charge	Q_{gs}		-	2.4	-	nC
Gate-Drain Charge	Q_{gd}		-	3	-	nC
Drain-Source Diode Characteristics						
Diode Forward Voltage (Note 3)	V_{SD}	$V_{GS}=0V, I_S=1A$	-	-	1.2	V
Diode Forward Current (Note 2)	I_S		-	-	2.5	A

Notes:

1. Repetitive Rating: Pulse width limited by maximum junction temperature.
2. Surface Mounted on FR4 Board, $t \leq 10$ sec.
3. Pulse Test: Pulse Width $\leq 300\mu s$, Duty Cycle $\leq 2\%$.
4. Guaranteed by design, not subject to product.



Typical Electrical and Thermal Characteristics

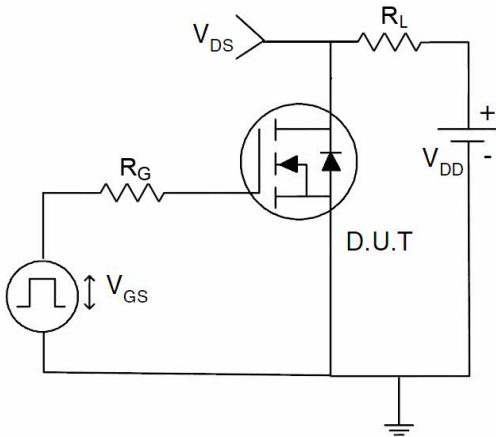

Figure 1 Switching Test Circuit

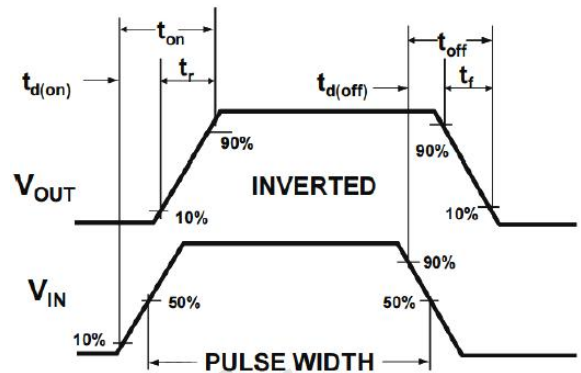

Figure 2 Switching Waveform

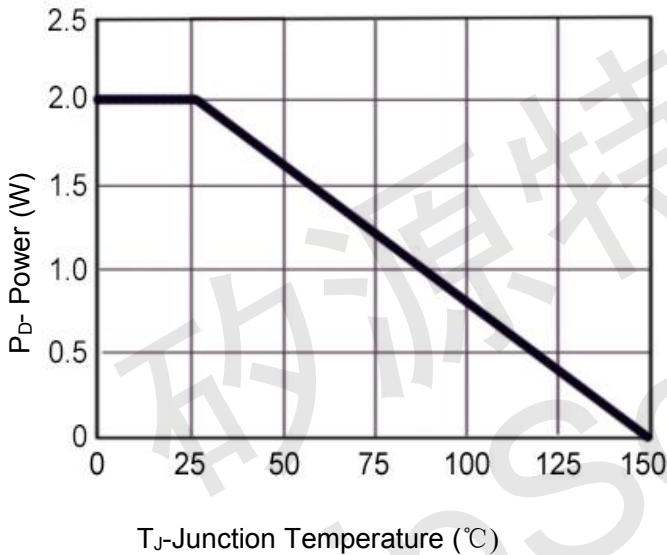

Figure 3 Power De-rating

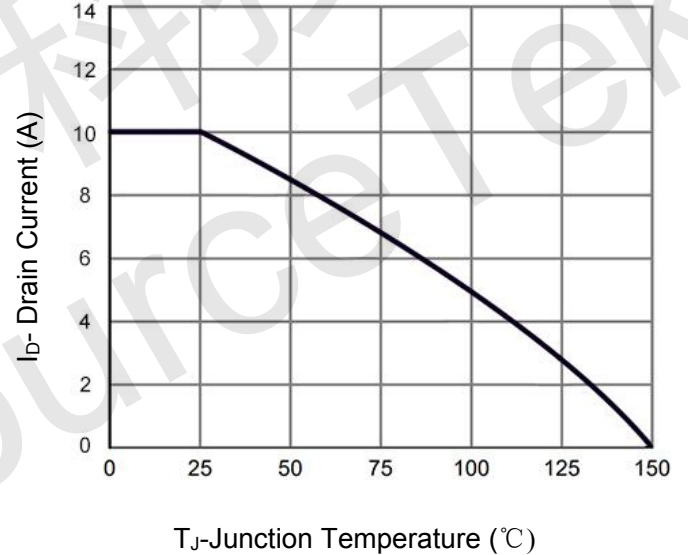

Figure 4 Drain Current

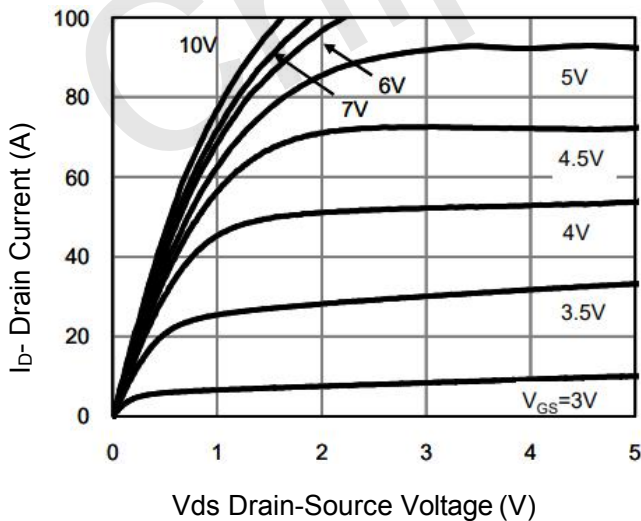

Figure 5 Output Characteristics

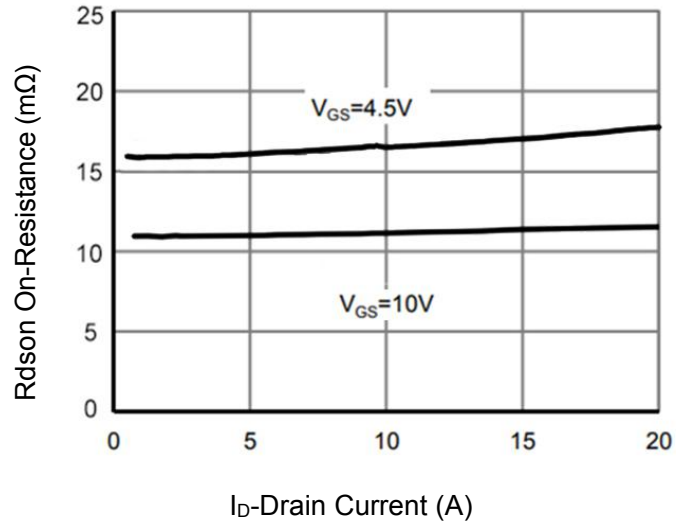

Figure 6 R_{dson} vs Drain Current

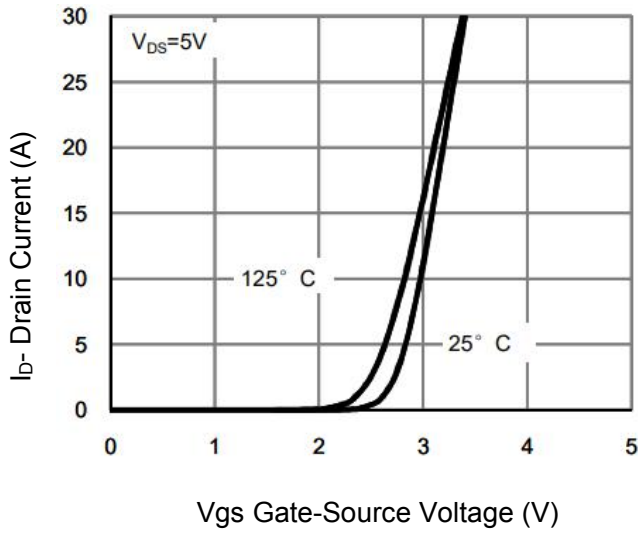

Figure 7 Transfer Characteristics

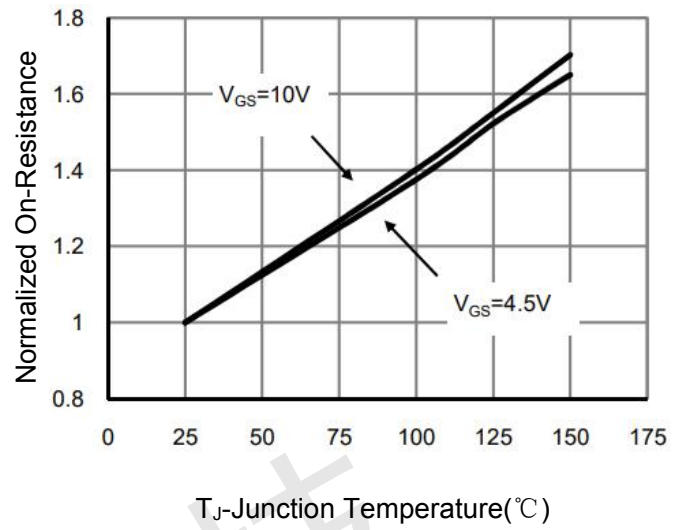

Figure 8 R_{dson} vs Junction Temperature

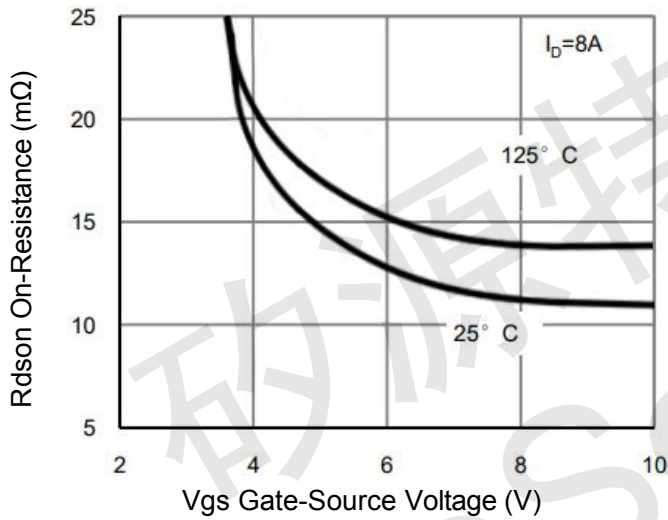

Figure 9 R_{dson} vs V_{GS}

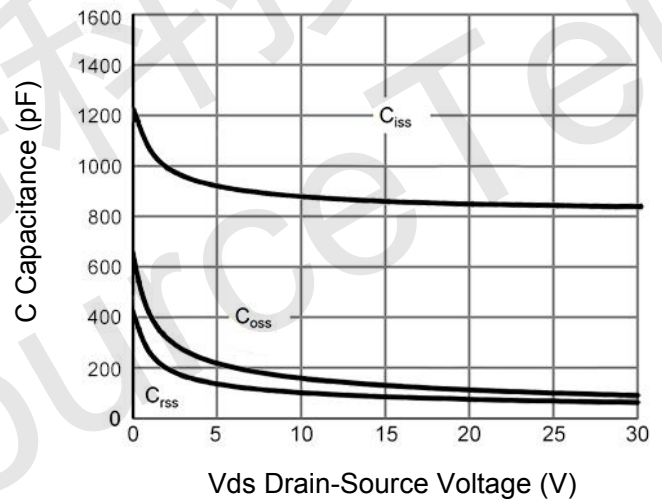

Figure 10 Capacitance vs V_{ds}

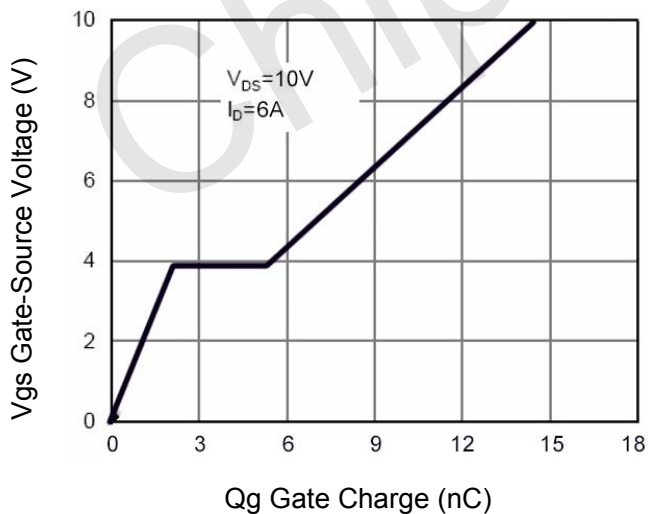

Figure 11 Gate Charge

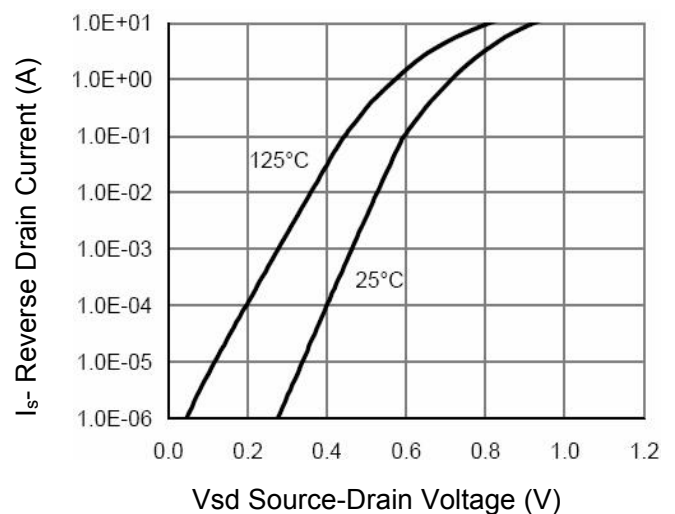

Figure 12 Source- Drain Diode Forward

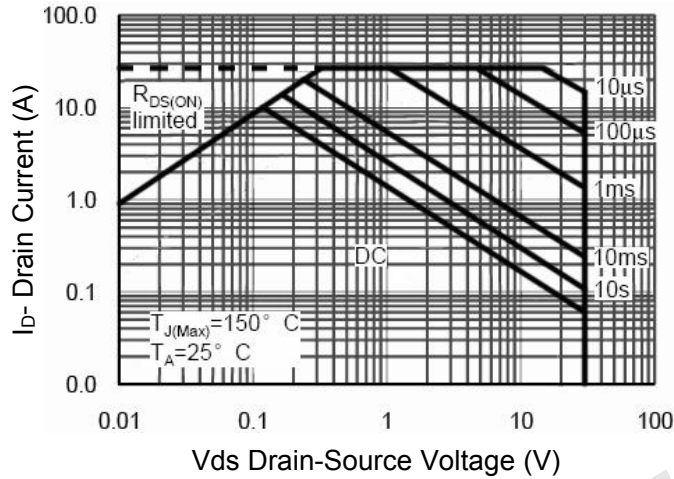

Figure 13 Safe Operation Area

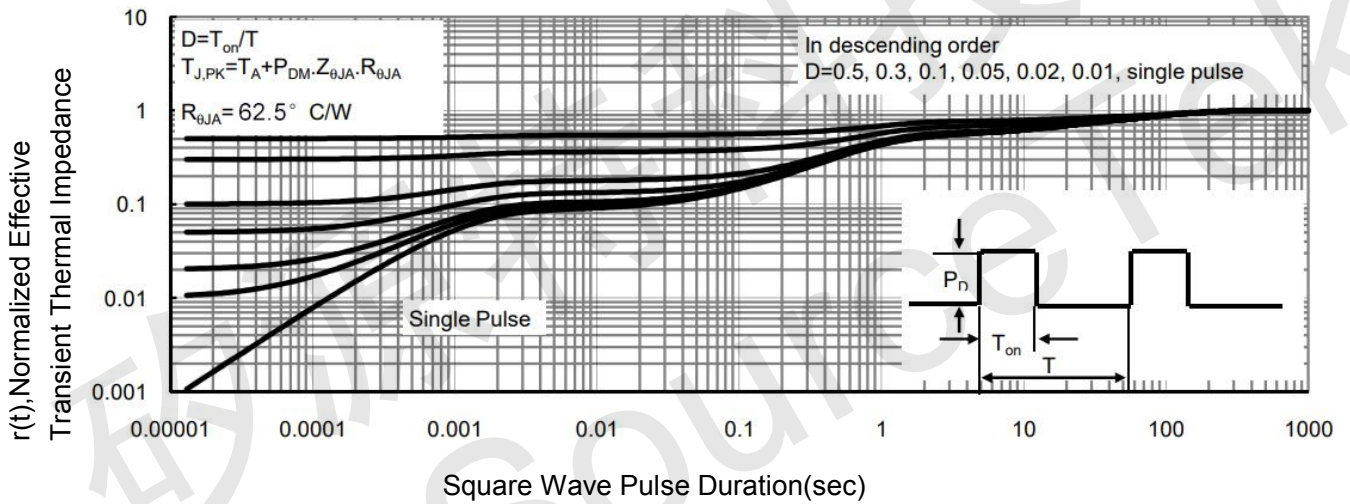
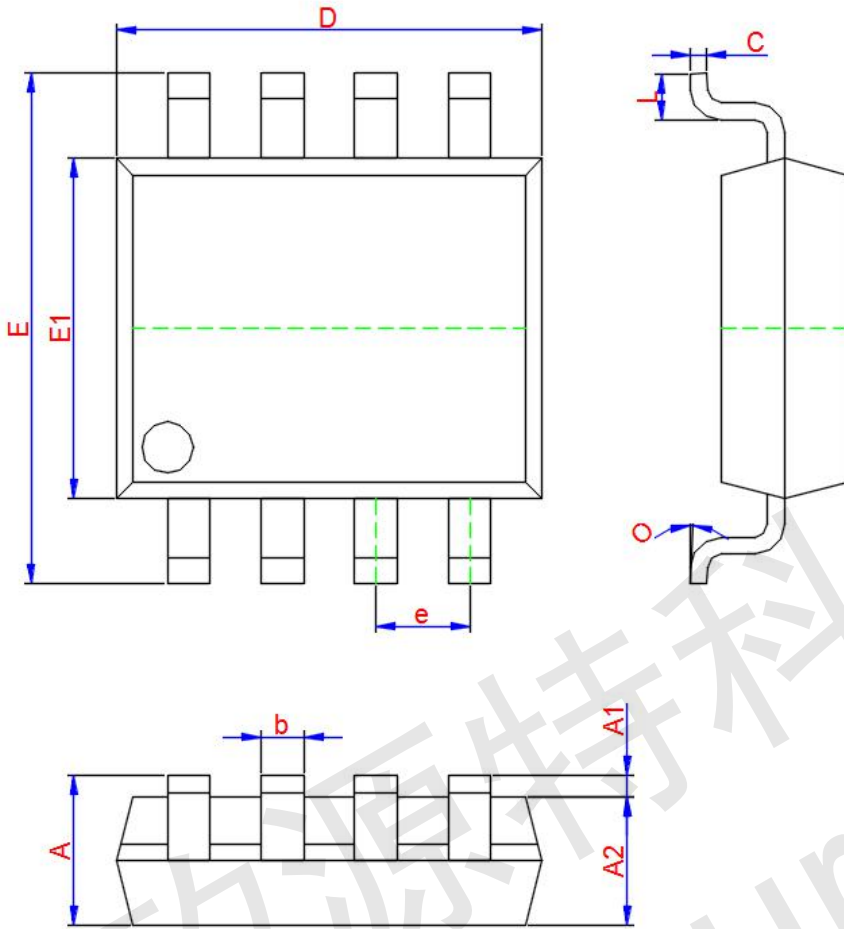

Figure 14 Normalized Maximum Transient Thermal Impedance



SOP-8 Package Information



Symbol	Dimensions In Millimeters		
	Min.	Typ.	Max.
A	1.350	1.550	1.750
A1	0.100	0.175	0.250
A2	1.350	1.450	1.550
b	0.330	0.420	0.510
c	0.170	0.210	0.250
D	4.700	4.900	5.100
e	1.270 TYP.		
E	5.800	6.000	6.200
E1	3.750	3.900	4.050
L	0.400	0.835	1.270
O	0°	4°	8°