



N and P Channel Enhancement Mode Power MOSFET

Description

The PE3024KC uses advanced trench technology to provide excellent $R_{DS(ON)}$ and low gate charge. It can be used in a wide variety of applications.

General Features

- **N-Channel**
 - $V_{DS} = 30V$, $I_D = 18A$
 - $R_{DS(ON)} < 14m\Omega @ V_{GS}=10V$
 - $R_{DS(ON)} < 20m\Omega @ V_{GS}=4.5V$
- **P-Channel**
 - $V_{DS} = -30V$, $I_D = -14A$
 - $R_{DS(ON)} < 29m\Omega @ V_{GS}=-10V$
 - $R_{DS(ON)} < 43m\Omega @ V_{GS}=-4.5V$
- High Power and current handing capability
- Lead free product is acquired
- Surface Mount Package

Application

- DC motor
- PWM applications

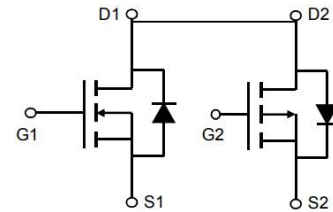

Schematic diagram

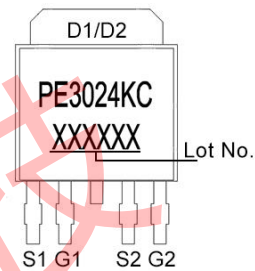

Marking and pin assignment

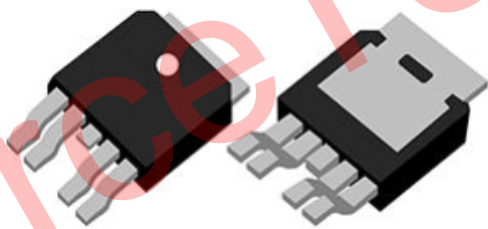

TO-252-4L

Absolute Maximum Ratings (TC=25°C unless otherwise noted)

Parameter	Symbol	N-Channel	P-Channel	Unit
Drain-Source Voltage	V_{DS}	30	-30	V
Gate-Source Voltage	V_{GS}	± 20	± 20	V
Drain Current-Continuous	I_D	18	-14	A
Pulsed Drain Current (Note 1)	I_{DM}	50	-36	A
Maximum Power Dissipation	P_D	15.5	27	W
Avalanche Current	I_{AS}	29	-29	A
Avalanche Energy (L=0.1mH)	E_{AS}	42	42	mJ
Operating Junction and Storage Temperature Range	T_J, T_{STG}	-55 To 150		°C

Thermal Characteristic

Parameter	Symbol	N-Channel	P-Channel	Unit
Thermal Resistance, Junction-to-Case (Note 2)	$R_{\theta JC}$	8	4.6	°C/W



N-Channel Electrical Characteristics (TC=25°C unless otherwise noted)

Parameter	Symbol	Condition	Min	Typ	Max	Unit
Off Characteristics						
Drain-Source Breakdown Voltage	BV_{DSS}	$V_{GS}=0V, I_D=250\mu A$	30	-	-	V
Zero Gate Voltage Drain Current	I_{DSS}	$V_{DS}=30V, V_{GS}=0V$	-	-	1	μA
Gate-Body Leakage Current	I_{GSS}	$V_{GS}=\pm 20V, V_{DS}=0V$	-	-	± 100	nA
On Characteristics (Note 3)						
Gate Threshold Voltage	$V_{GS(th)}$	$V_{DS}=V_{GS}, I_D=250\mu A$	1	1.5	2.2	V
Drain-Source On-State Resistance	$R_{DS(on)}$	$V_{GS}=10V, I_D=8A$	-	10	14	m Ω
		$V_{GS}=4.5V, I_D=6A$	-	15	20	m Ω
Forward Transconductance	g_{FS}	$V_{DS}=5V, I_D=8A$	-	24	-	S
Dynamic Characteristics (Note 4)						
Input Capacitance	C_{iss}	$V_{DS}=15V, V_{GS}=0V,$ $F=1.0MHz$	-	840	-	pF
Output Capacitance	C_{oss}		-	120	-	pF
Reverse Transfer Capacitance (Note 4)	C_{rss}		-	85	-	pF
Switching Characteristics						
Turn-on Delay Time	$t_{d(on)}$	$V_{DD}=15V, I_D=2A, R_L=1\Omega,$ $V_{GS}=10V, R_G=3\Omega$	-	4.2	-	nS
Turn-on Rise Time	t_r		-	8.2	-	nS
Turn-Off Delay Time	$t_{d(off)}$		-	31	-	nS
Turn-Off Fall Time	t_f		-	4	-	nS
Total Gate Charge	Q_g	$V_{DS}=15V, I_D=6A, V_{GS}=10V$	-	14	-	nC
Gate-Source Charge	Q_{gs}		-	2.4	-	nC
Gate-Drain Charge	Q_{gd}		-	3	-	nC
Drain-Source Diode Characteristics						
Diode Forward Voltage (Note 3)	V_{SD}	$V_{GS}=0V, I_S=1A$	-	-	1.2	V
Diode Forward Current (Note 2)	I_S		-	-	10	A

Notes:

1. Repetitive Rating: Pulse width limited by maximum junction temperature.
2. Surface Mounted on FR4 Board, $t \leq 10$ sec.
3. Pulse Test: Pulse Width $\leq 300\mu s$, Duty Cycle $\leq 2\%$.
4. Guaranteed by design, not subject to product.



Typical Electrical and Thermal Characteristics

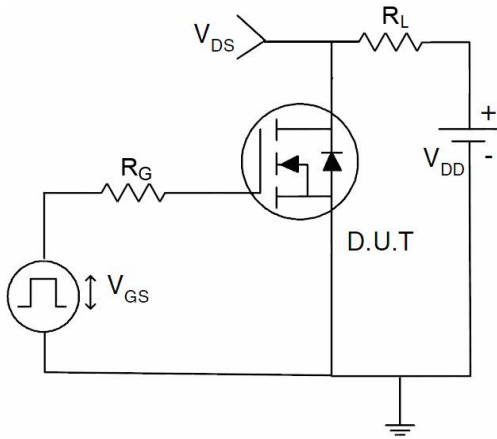

Figure 1 Switching Test Circuit

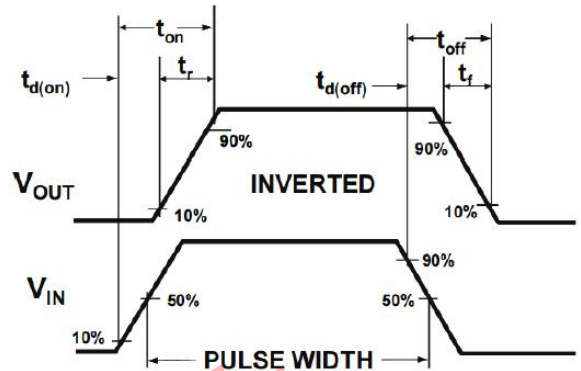

Figure 2 Switching Waveform

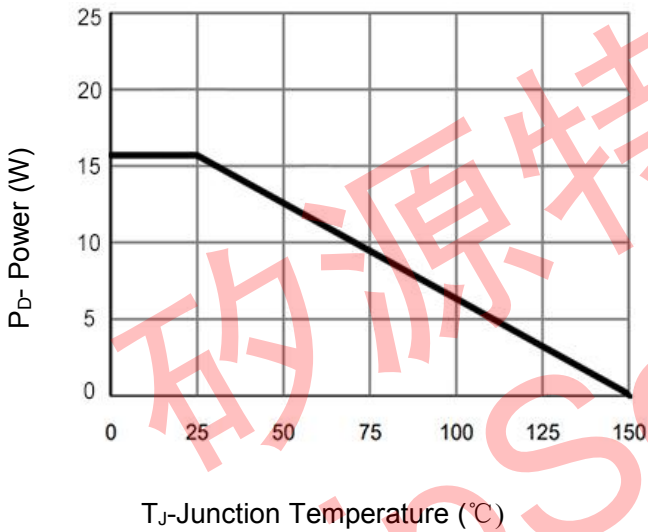

Figure 3 Power De-rating

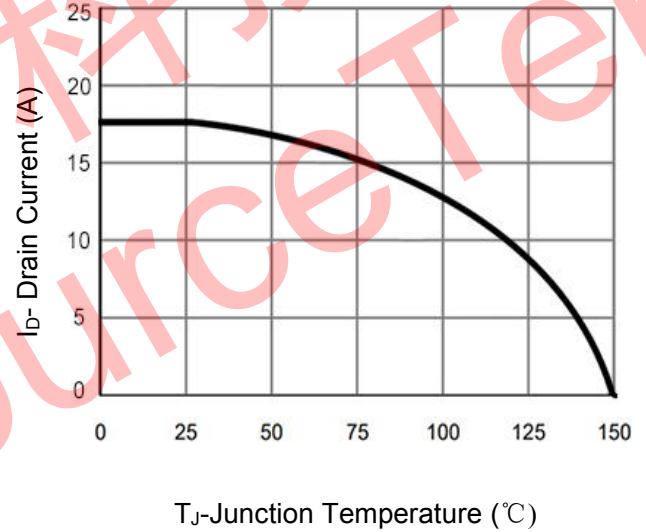

Figure 4 Drain Current

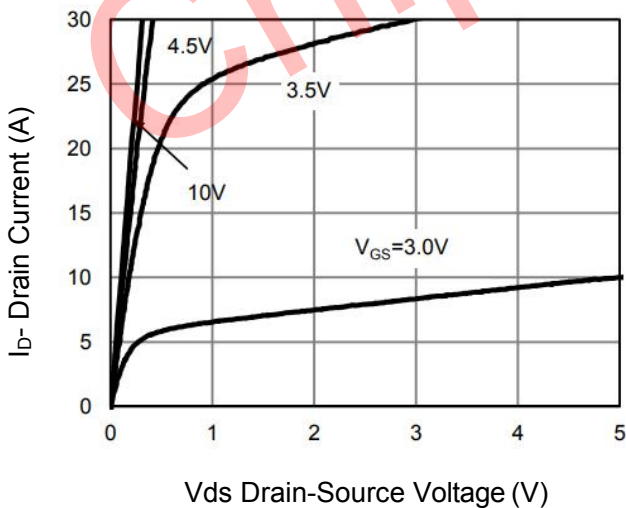

Figure 5 Output Characteristics

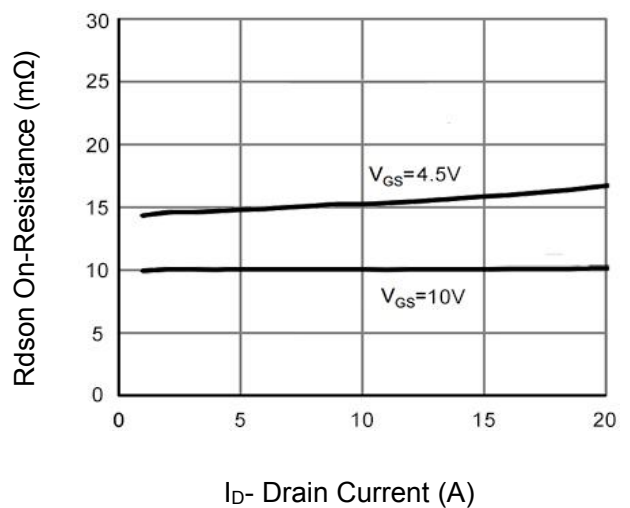

Figure 6 R_dson vs Drain Current

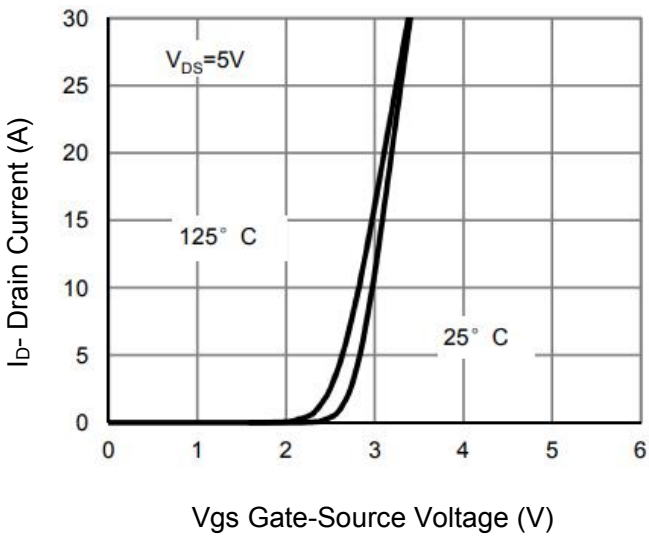

Figure 7 Transfer Characteristics

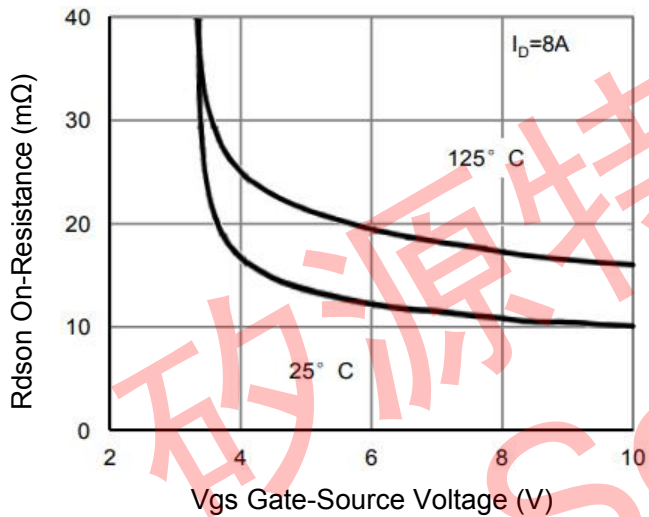

Figure 9 Rdson vs Vgs

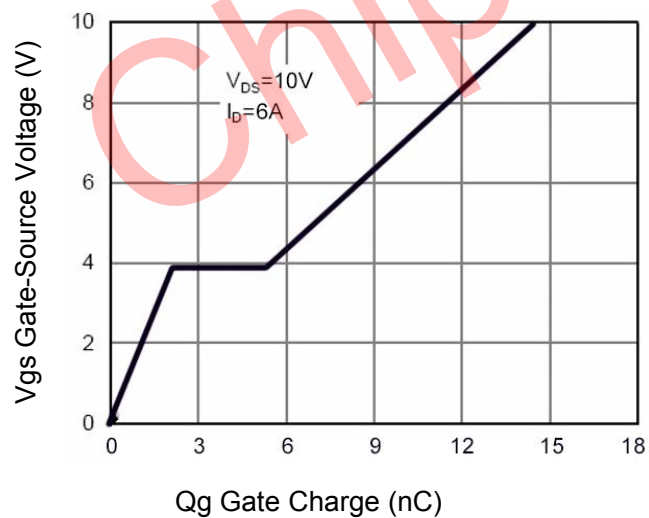

Figure 11 Gate Charge

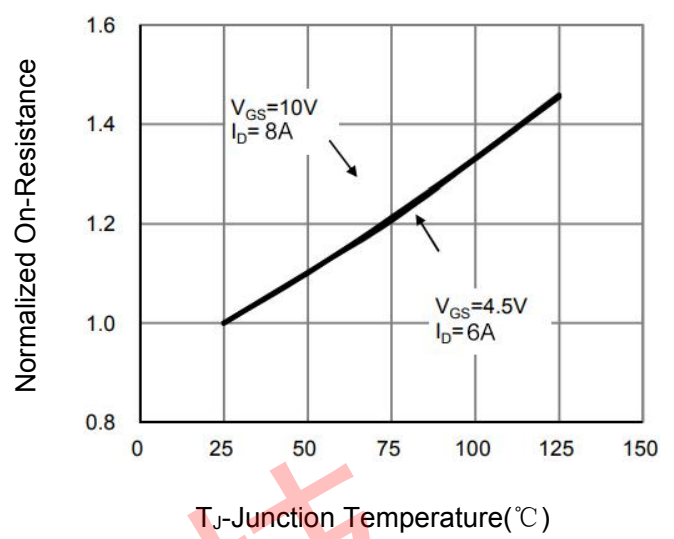

Figure 8 Rdson vs Junction Temperature

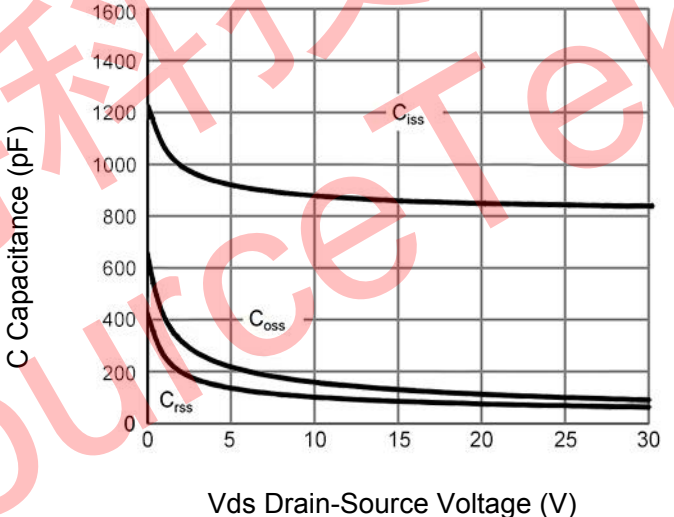

Figure 10 Capacitance vs Vds

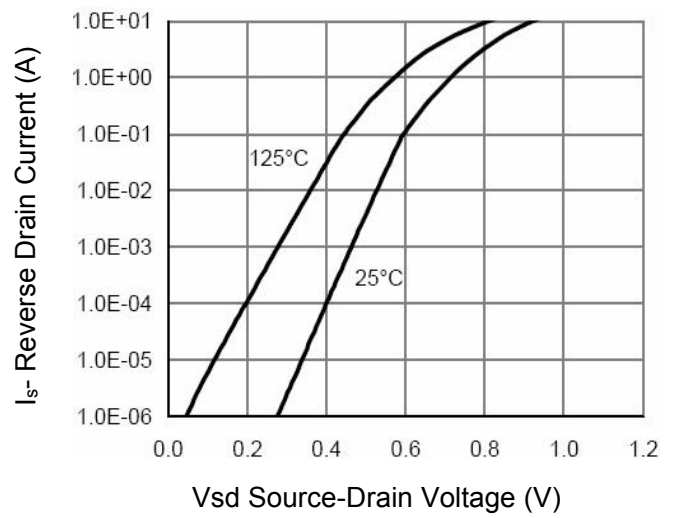

Figure 12 Source- Drain Diode Forward

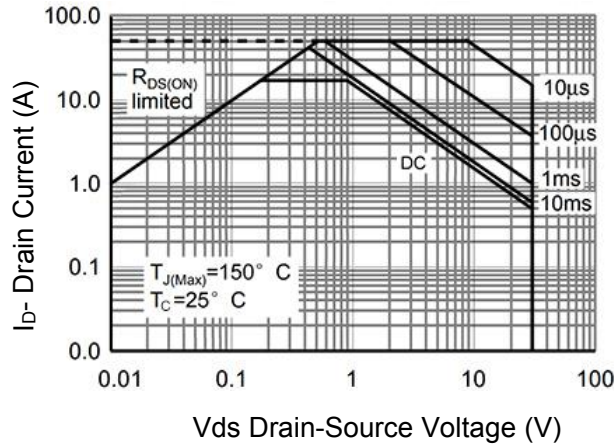

Figure 13 Safe Operation Area

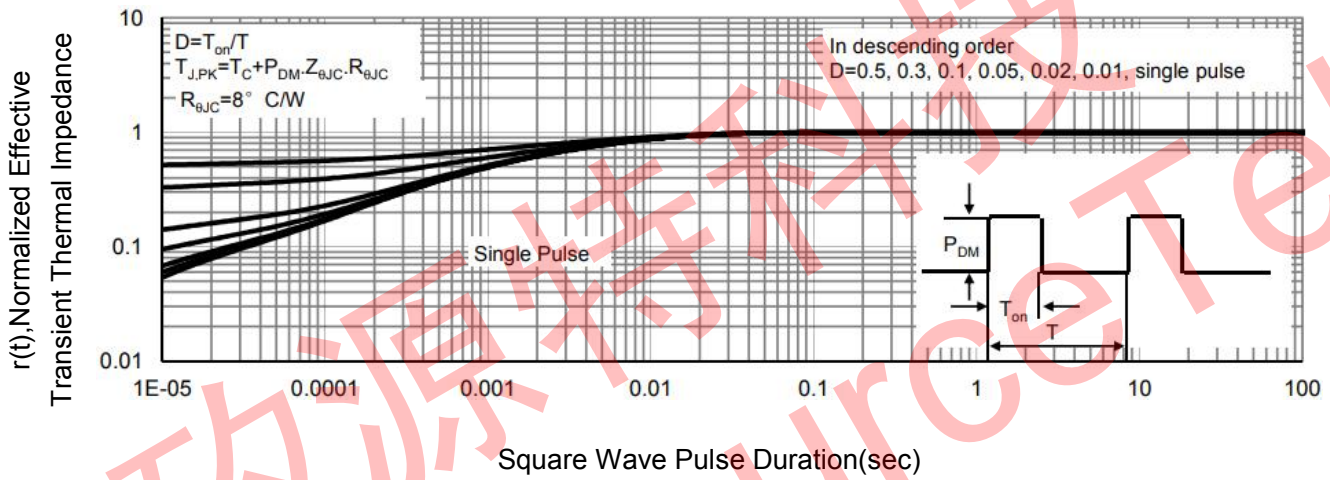

Figure 14 Normalized Maximum Transient Thermal Impedance



P-Channel Electrical Characteristics (TC=25°C unless otherwise noted)

Parameter	Symbol	Condition	Min	Typ	Max	Unit
Off Characteristics						
Drain-Source Breakdown Voltage	BV_{DSS}	$V_{GS}=0V, I_D=-250\mu A$	-30	-	-	V
Zero Gate Voltage Drain Current	I_{DSS}	$V_{DS}=-30V, V_{GS}=0V$	-	-	1	μA
Gate-Body Leakage Current	I_{GSS}	$V_{GS}=\pm 20V, V_{DS}=0V$	-	-	± 100	nA
On Characteristics (Note 3)						
Gate Threshold Voltage	$V_{GS(th)}$	$V_{DS}=V_{GS}, I_D=-250\mu A$	-1	-1.5	-2.2	V
Drain-Source On-State Resistance	$R_{DS(on)}$	$V_{GS}=-10V, I_D=-7A$	-	24	29	m Ω
		$V_{GS}=-4.5V, I_D=-5A$	-	33	43	m Ω
Forward Transconductance	g_{FS}	$V_{DS}=-10V, I_D=-6A$	-	15	-	S
Dynamic Characteristics (Note 4)						
Input Capacitance	C_{iss}	$V_{DS}=-15V, V_{GS}=0V,$ $F=1.0MHz$	-	480	-	pF
Output Capacitance	C_{oss}		-	120	-	pF
Reverse Transfer Capacitance (Note 4)	C_{rss}		-	54	-	pF
Switching Characteristics						
Turn-on Delay Time	$t_{d(on)}$	$V_{DD}=-15V, I_D=-2A, R_L=1\Omega,$ $V_{GS}=-10V, R_G=3\Omega$	-	8	-	nS
Turn-on Rise Time	t_r		-	5	-	nS
Turn-Off Delay Time	$t_{d(off)}$		-	28	-	nS
Turn-Off Fall Time	t_f		-	12	-	nS
Total Gate Charge	Q_g	$V_{DS}=-15V, I_D=-4A, V_{GS}=-10V$	-	14	-	nC
Gate-Source Charge	Q_{gs}		-	2	-	nC
Gate-Drain Charge	Q_{gd}		-	3	-	nC
Drain-Source Diode Characteristics						
Diode Forward Voltage (Note 3)	V_{SD}	$V_{GS}=0V, I_S=-1A$	-	-	-1.2	V
Diode Forward Current (Note 2)	I_S		-	-	-10	A

Notes:

1. Repetitive Rating: Pulse width limited by maximum junction temperature.
2. Surface Mounted on FR4 Board, $t \leq 10$ sec.
3. Pulse Test: Pulse Width $\leq 300\mu s$, Duty Cycle $\leq 2\%$.
4. Guaranteed by design, not subject to product.



Typical Electrical and Thermal Characteristics

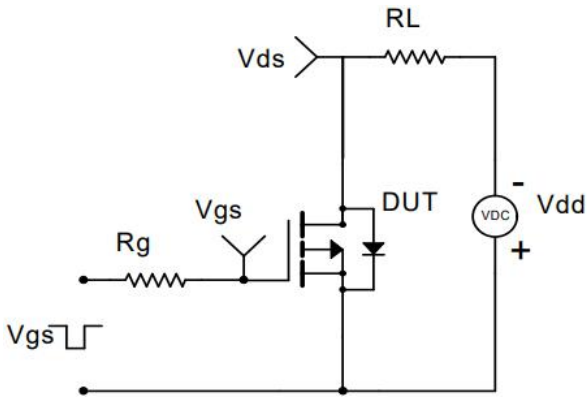

Figure 1 Switching Test Circuit

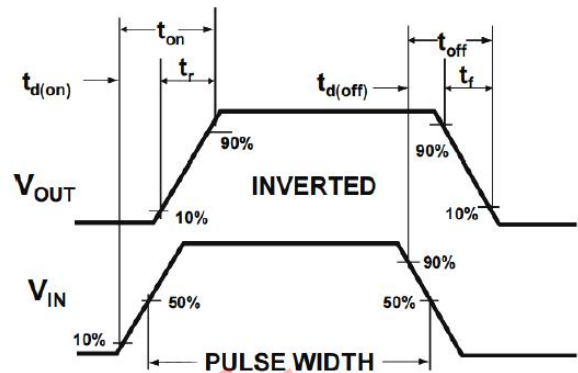

Figure 2 Switching Waveform

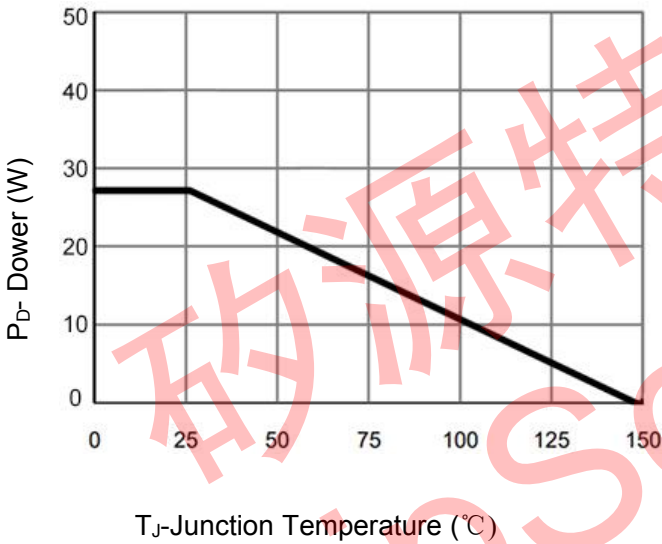

Figure 3 Power De-rating

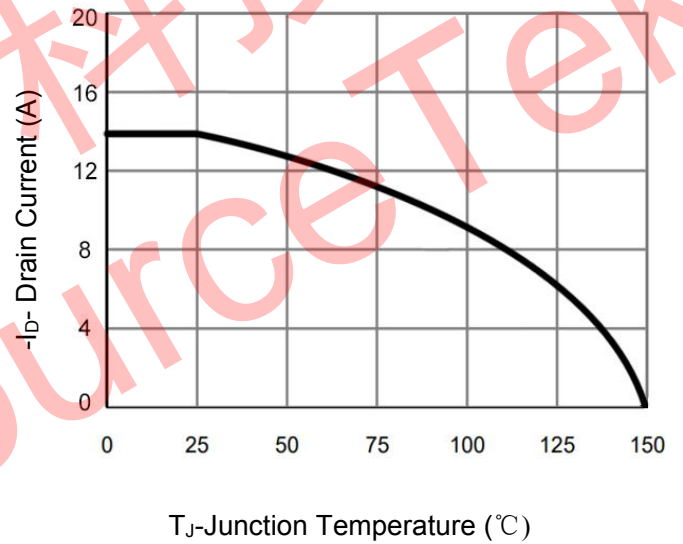

Figure 4 Drain Current

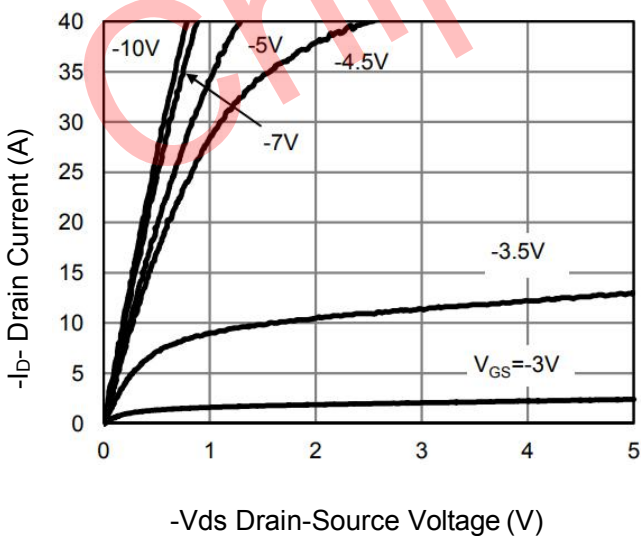

Figure 5 Output Characteristics

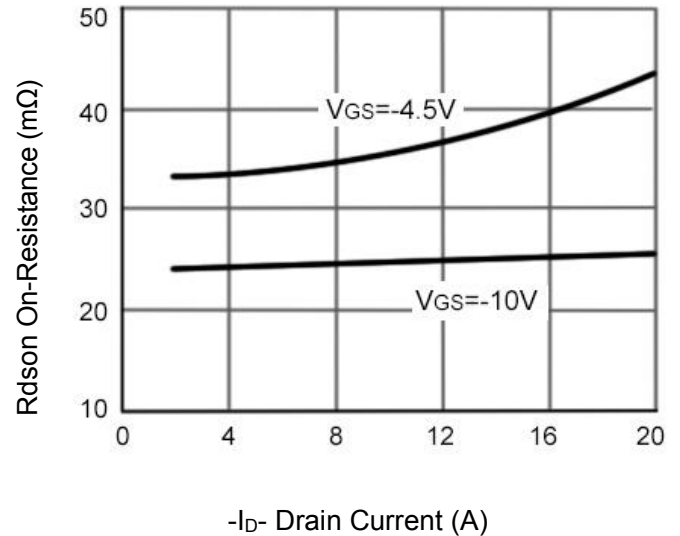

Figure 6 Rdson vs Drain Current

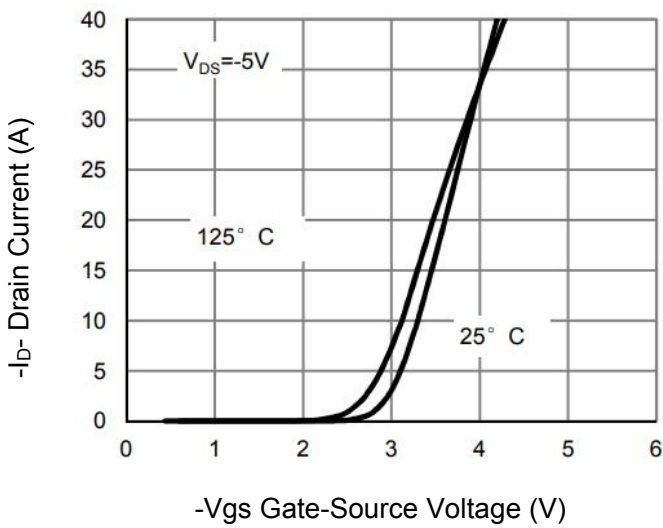

Figure 7 Transfer Characteristics

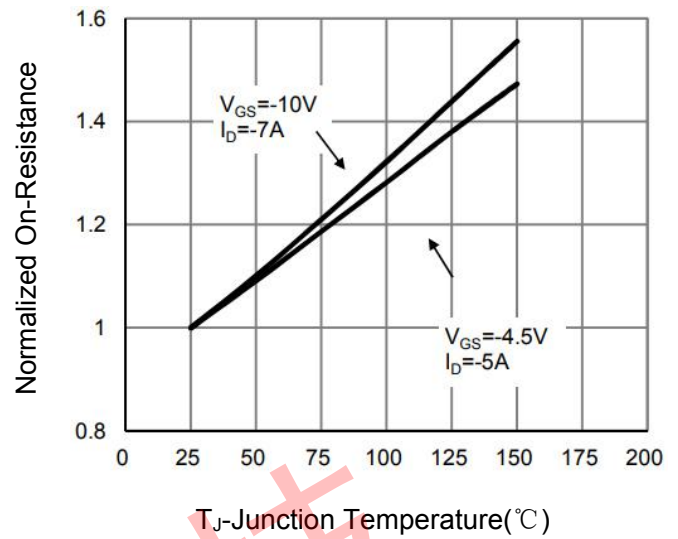

Figure 8 Rdson vs Junction Temperature

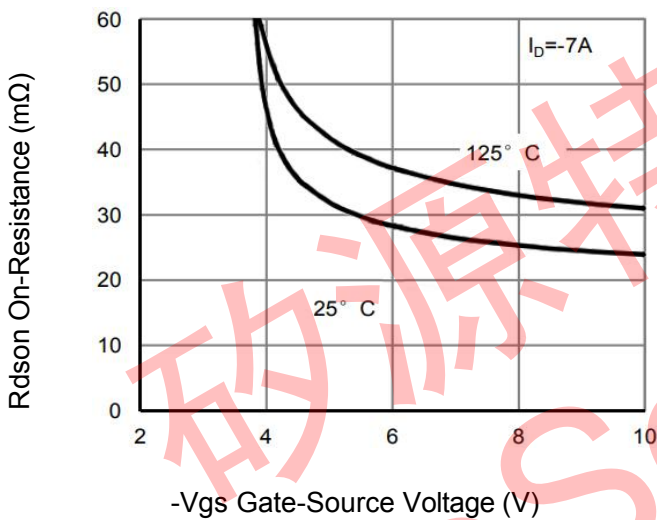

Figure 9 Rdson vs Vgs

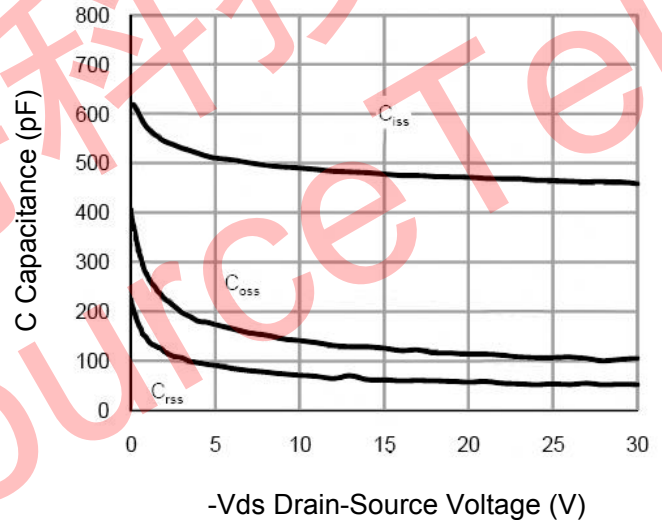

Figure 10 Capacitance vs Vds

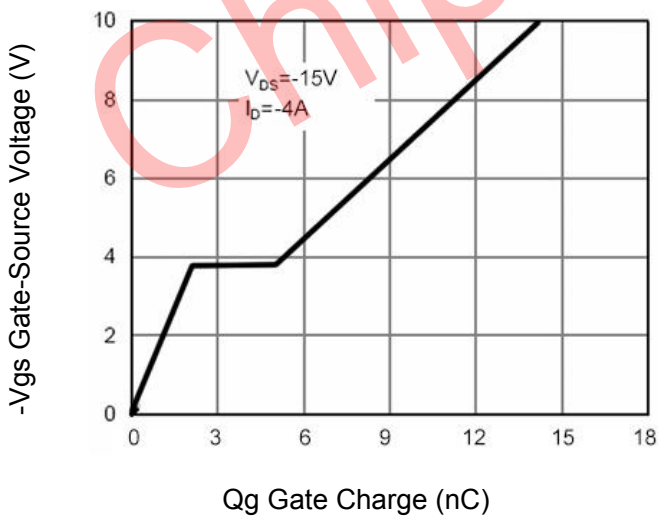

Figure 11 Gate Charge

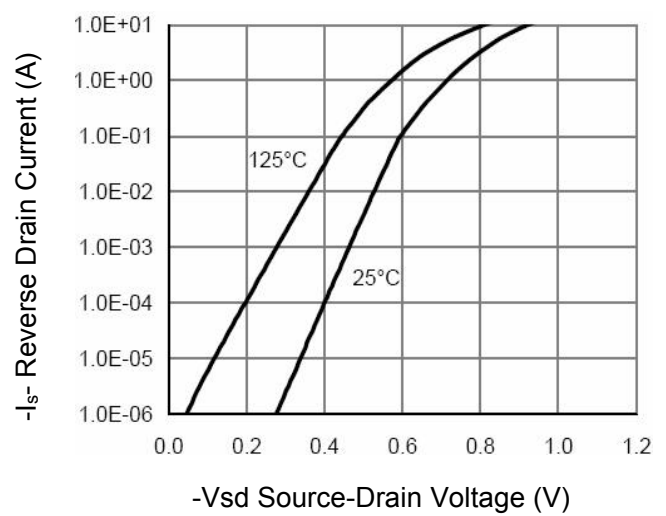

Figure 12 Source- Drain Diode Forward

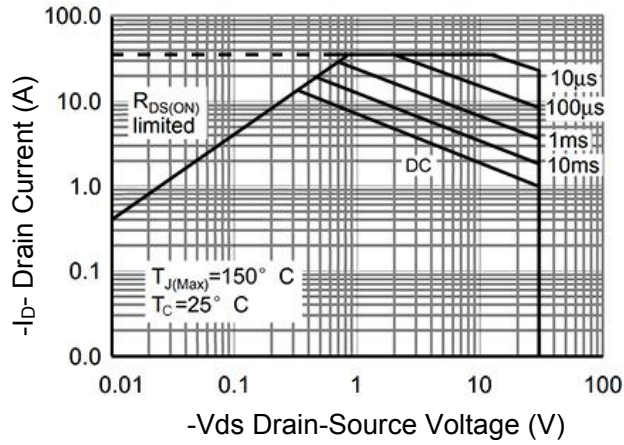

Figure 13 Safe Operation Area

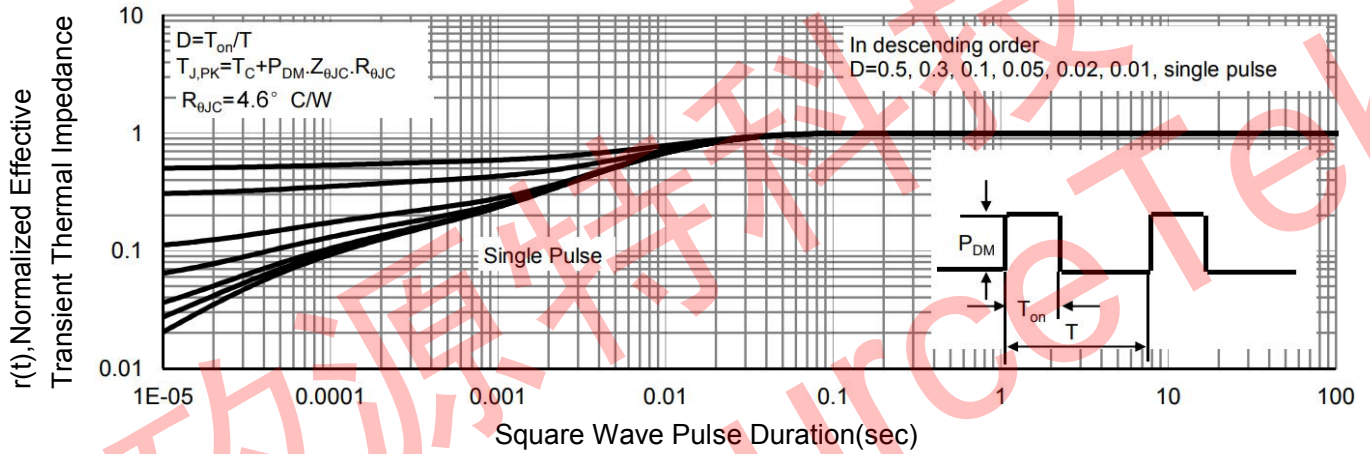
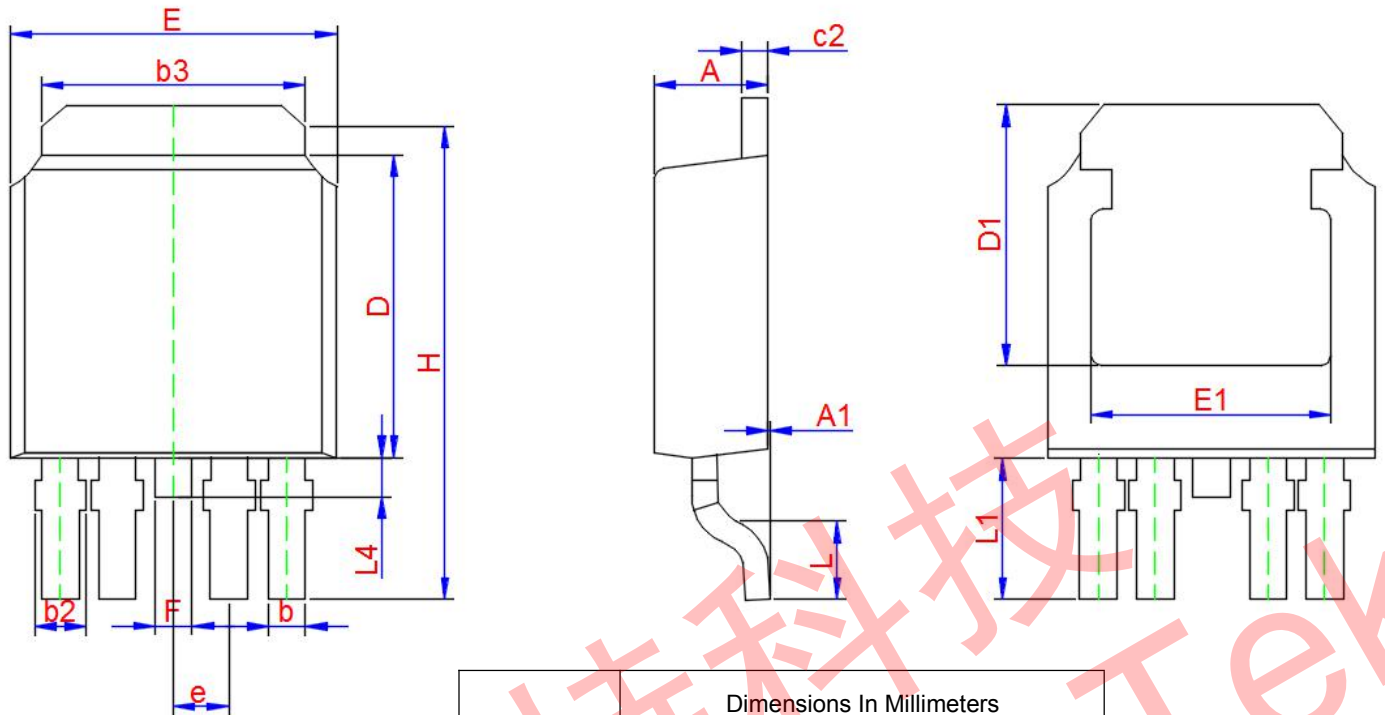

Figure 14 Normalized Maximum Transient Thermal Impedance



TO-252-4L Package Information



Symbol	Dimensions In Millimeters		
	Min.	Typ.	Max.
A	2.200	2.300	2.400
A1	0.000	0.080	0.150
b	0.450	0.530	0.600
b2	0.500	0.650	0.800
b3	5.200	5.350	5.500
c2	0.450	0.500	0.550
D	5.400	5.600	5.800
D1	4.570	-	-
E	6.400	6.600	6.800
E1	3.810	-	-
e	1.27TYP.		
F	0.400	0.500	0.600
H	9.400	9.800	10.200
L	1.400	1.590	1.770
L1	2.400	2.700	3.000
L4	0.800	1.000	1.200