



N-Channel Enhancement Mode Power MOSFET

The MX8205L uses advanced trench technology to provide excellent $R_{DS(ON)}$, low gate charge and operation with gate voltages as low as 2.5V. This device is suitable for use as a Battery protection or in other Switching applications.

General Features

- ◆ $V_{DS} = 20V, I_D = 6A$
- ◆ $R_{DS(ON)} (Typ.) = 16m\Omega @ V_{GS} = 4.5V$
- ◆ $R_{DS(ON)} (Typ.) = 17m\Omega @ V_{GS} = 3.8V$
- ◆ $R_{DS(ON)} (Typ.) = 21m\Omega @ V_{GS} = 2.5V$
- ◆ High Power and current handling capability
- ◆ Lead free product is acquired
- ◆ Surface Mount Package

Application

Battery protection
Load switch
Power management

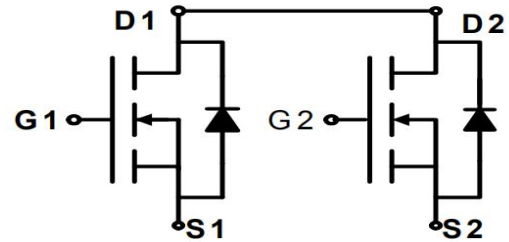

Schematic diagram

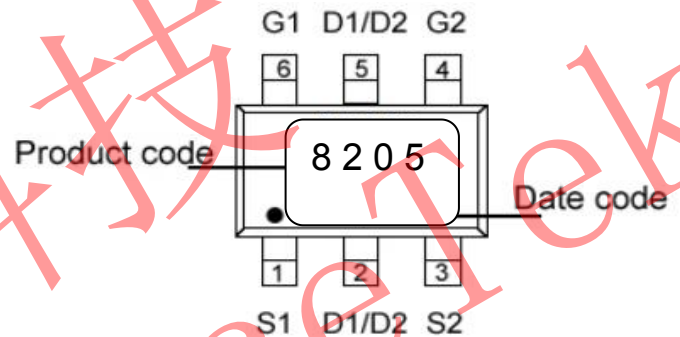

Marking and pin assignment



SOT-23-6 (TOP VIEW)

ASO Absolute Maximum Ratings (TA=25°C unless otherwise noted)

Parameter	Symbol	Limit	Unit
Drain-Source Voltage	V_{DS}	20	V
Gate-Source Voltage	V_{GS}	± 12	V
Drain Current-Continuous	I_D	6	A
Drain Current-Pulsed (Note 1)	I_{DM}	24	A
Maximum Power Dissipation	P_D	1.25	W
Operating Junction and Storage Temperature Range	T_J, T_{STG}	-55 To 150	°C



Thermal Characteristic

Thermal Resistance, Junction-to-Ambient (Note 2)	$R_{\theta JA}$	83	$^{\circ}C/W$
--------------------------------------------------	-----------------	----	---------------

Electrical Characteristics (TA=25 $^{\circ}C$ unless otherwise noted)

Parameter	Symbol	Condition	Min	Typ	Max	Unit
Off Characteristics						
Drain-Source Breakdown Voltage	BV_{DSS}	$V_{GS}=0V, I_D=250\mu A$	20	21	-	V
Zero Gate Voltage Drain Current	I_{DSS}	$V_{DS}=19.5V, V_{GS}=0V$	-	-	1	μA
Gate-Body Leakage Current	I_{GSS}	$V_{GS}=\pm 10V, V_{DS}=0V$	-	-	± 100	nA
On Characteristics (Note 3)						
Gate Threshold Voltage	$V_{GS(th)}$	$V_{DS}=V_{GS}, I_D=250\mu A$	0.4	0.65	1	V
Drain-Source On-State Resistance	$R_{DS(on)}$	$V_{GS}=4.5V, I_D=4.5A$	-	16	20	$m\Omega$
		$V_{GS}=3.8V, I_D=4A$	-	17	21	
		$V_{GS}=2.5V, I_D=3.5A$	-	21	28	$m\Omega$
Forward Transconductance	g_{FS}	$V_{DS}=5V, I_D=4.5A$	-	10	-	S
Dynamic Characteristics (Note4)						
Input Capacitance	C_{iss}	$V_{DS}=8V, V_{GS}=0V,$ $F=1.0MHz$	-	600	-	PF
Output Capacitance	C_{oss}		-	330	-	PF
Reverse Transfer Capacitance	C_{rss}		-	140	-	PF
Switching Characteristics (Note 4)						
Turn-on Delay Time	$t_{d(on)}$	$V_{DD}=10V, I_D=1A,$ $V_{GS}=4.5V, R_G=6\Omega$	-	10	20	nS
Turn-on Rise Time	t_r		-	11	25	nS
Turn-Off Delay Time	$t_{d(off)}$		-	35	70	nS
Turn-Off Fall Time	t_f		-	30	60	nS
Total Gate Charge	Q_g	$V_{DS}=10V, I_D=6A,$ $V_{GS}=4.5V$	-	10	15	nC
Gate-Source Charge	Q_{gs}		-	2.3	-	nC
Gate-Drain Charge	Q_{gd}		-	1.5	-	nC
Drain-Source Diode Characteristics						
Diode Forward Voltage (Note 3)	V_{SD}	$V_{GS}=0V, I_S=1.7A$	-	0.75	1.2	V
Diode Forward Current (Note 2)	I_S		-	-	1.7	A

Notes:

1. Repetitive Rating: Pulse width limited by maximum junction temperature.
2. Surface Mounted on FR4 Board, $t \leq 10$ sec.
3. Pulse Test: Pulse Width $\leq 300\mu s$, Duty Cycle $\leq 2\%$.



TYPICAL ELECTRICAL AND THERMAL CHARACTERISTICS

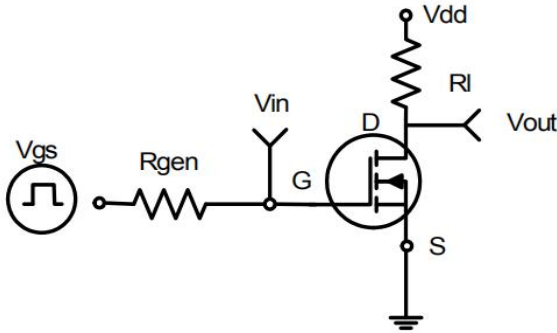

Figure 1: Switching Test Circuit

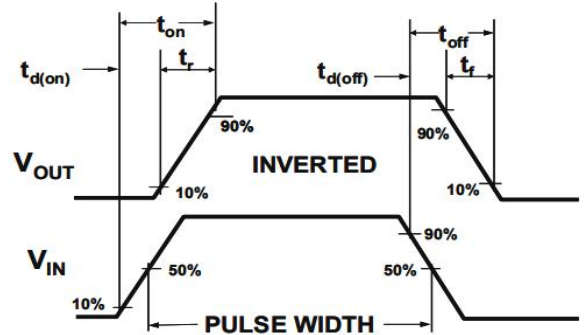

Figure 2: Switching Waveforms

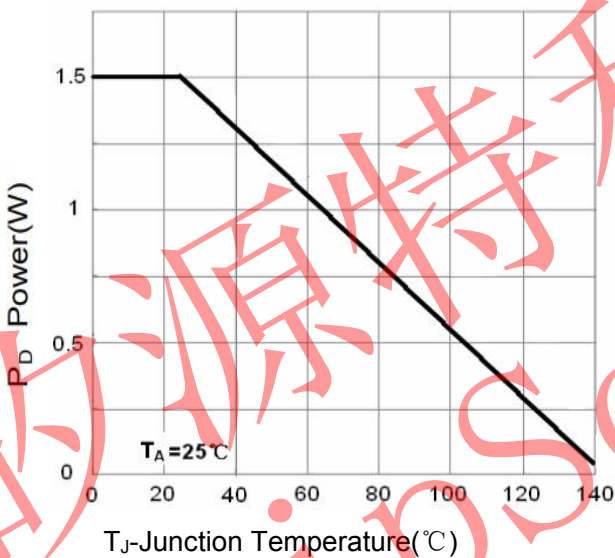

Figure 3 Power Dissipation

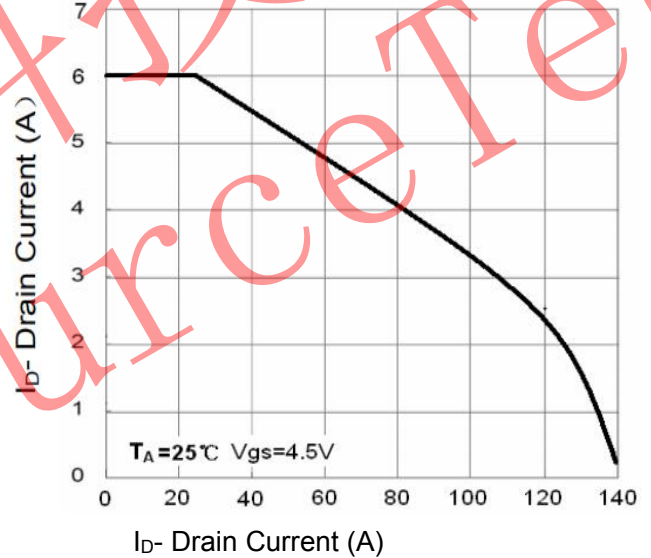

Figure 4 Drain-Source On-Resistance

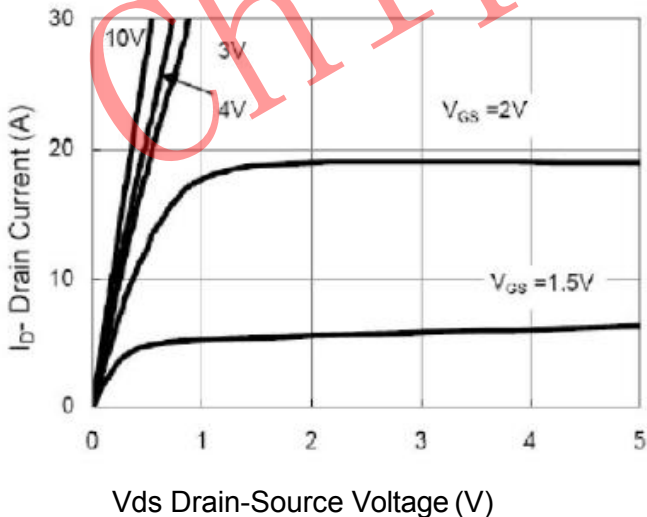

Figure 5. Capacitance

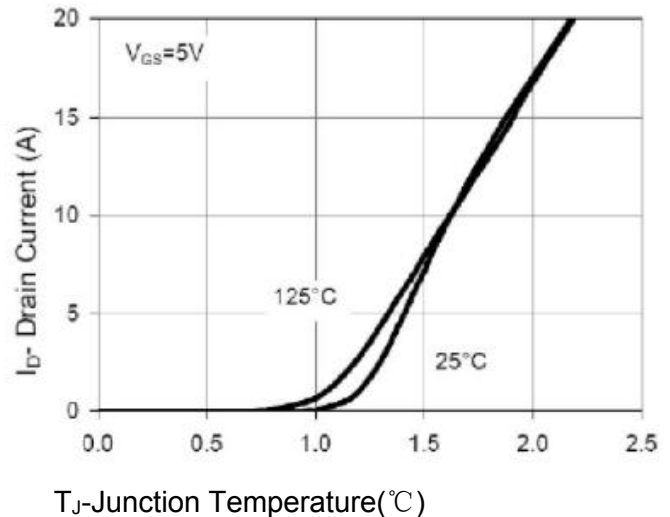

Figure 6. R_{DS(ON)} vs Junction Temperature

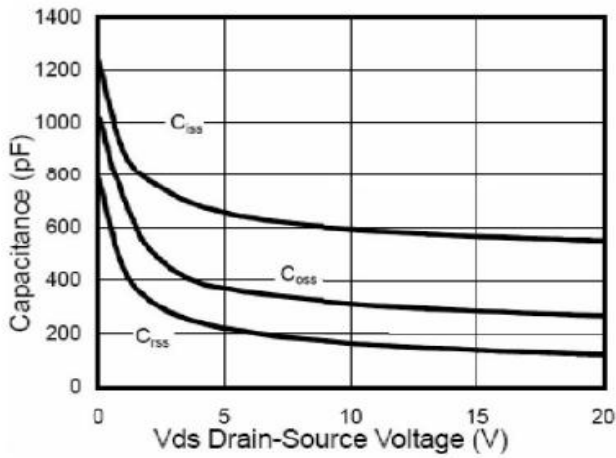

Figure7. Max V_{DSS} vs Junction Temperature

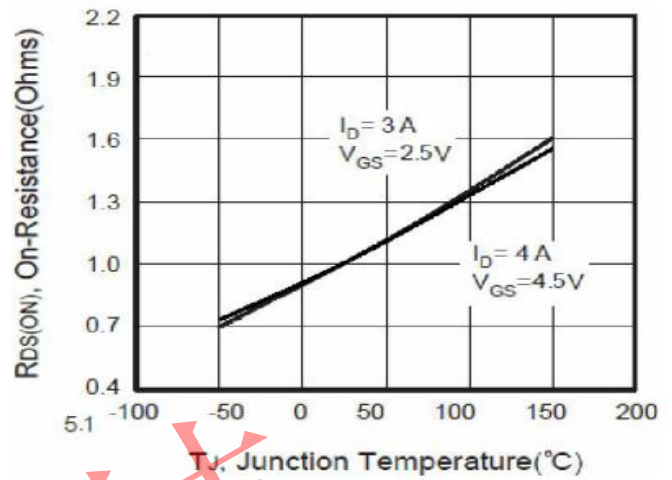

Figure8. $V_{GS(th)}$ vs Junction Temperature

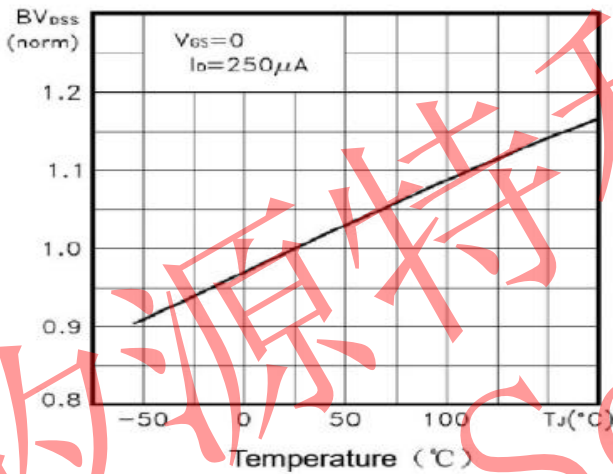

Figure9. Gate Charge Waveforme

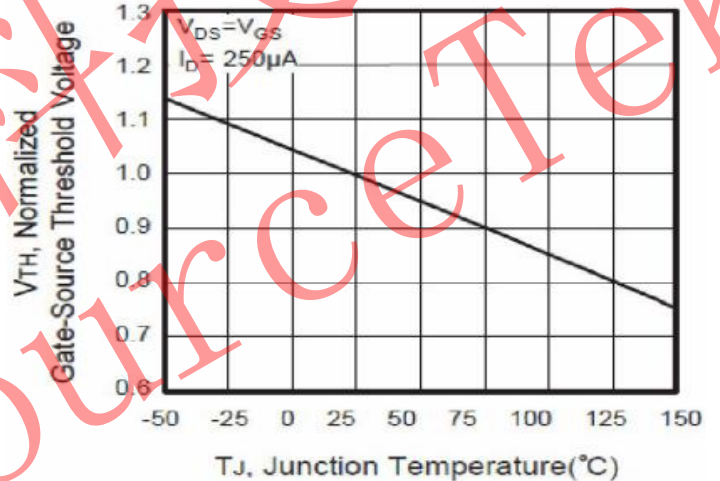

Figure10. Maximum Safe Operating Area

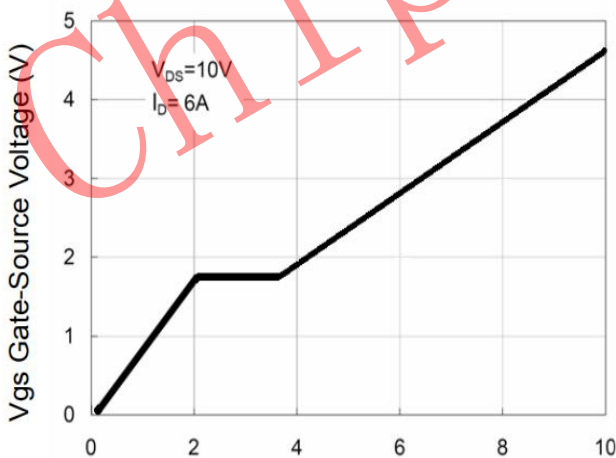

Figure 11 Gate Charge

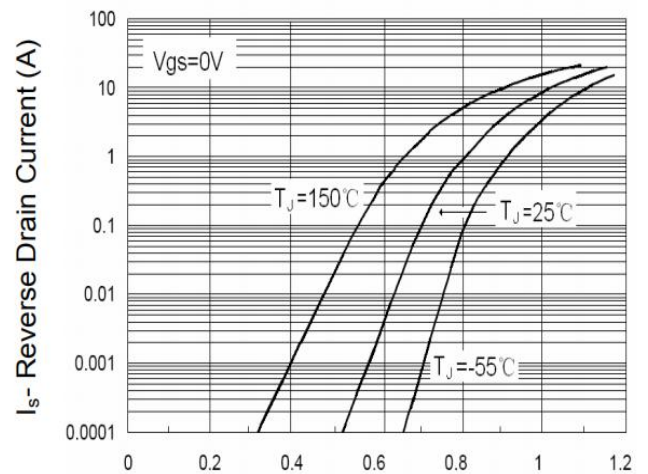

Figure 12 Safe Operation Area

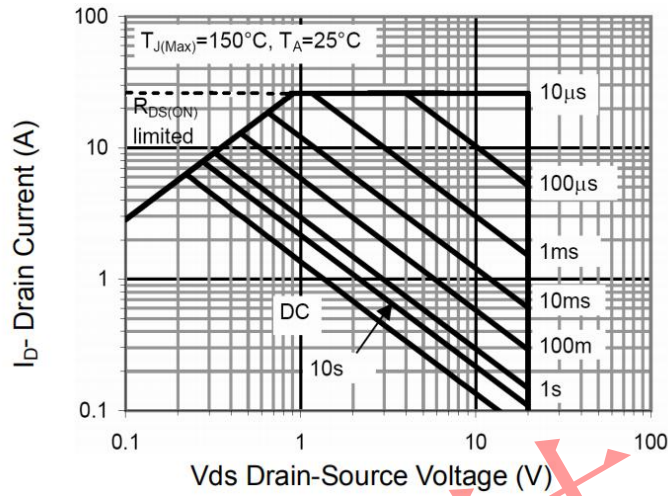

Figure 13 Safe Operation Area

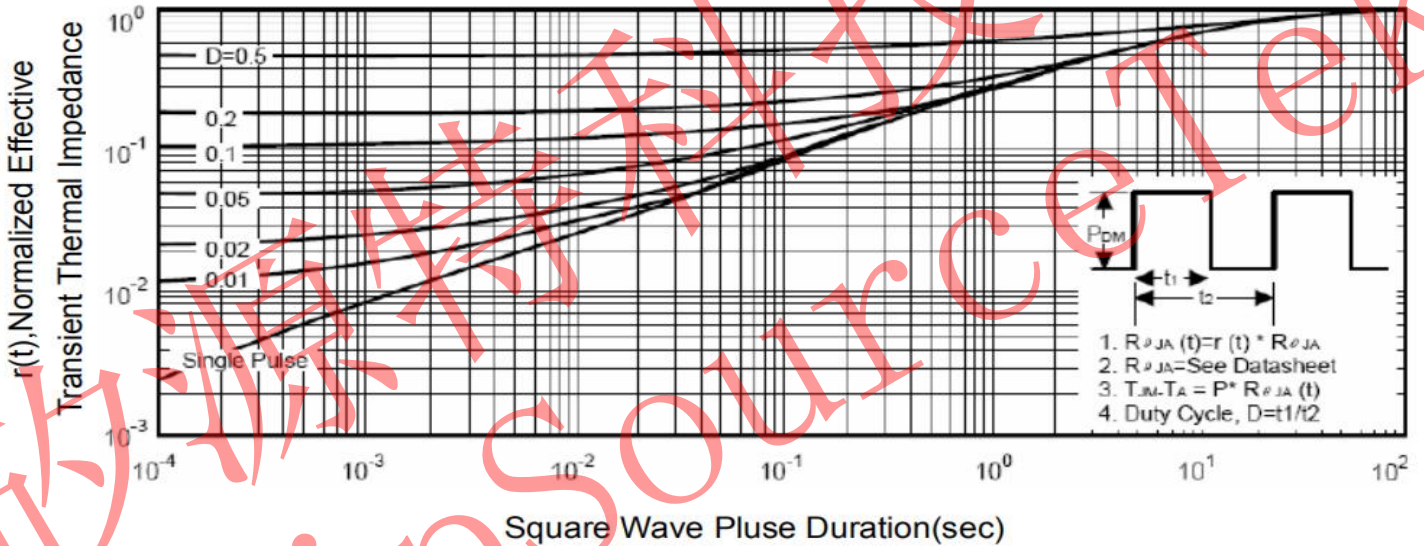
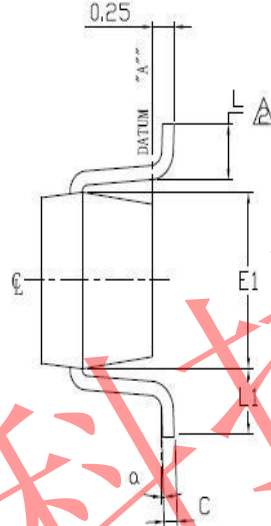
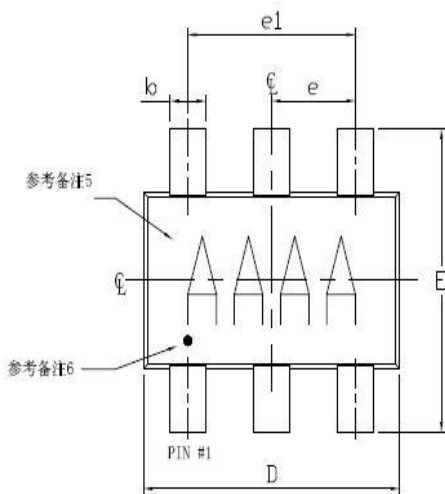

Figure 14 Normalized Maximum Transient Thermal Impedance



SOT23-6 PACKAGE IN



SYMBOL	MIN	NOM	MAX
A	0.90	1.25	1.45
A1	0.00	0.05	0.15
A2	0.90	1.10	1.30
b	0.35	0.40	0.50
C	0.08	0.15	0.20
D	2.80	2.90	3.00
E	2.60	2.80	3.00
E1	1.50	1.625	1.75
L	0.35	0.45	0.60
L1		0.60 REF.	
e1		1.90 BSC.	
e		0.95 BSC.	
a	0°	2.5°	8°

PKG CODES:
U6-1, U6-2, U6-4, U6CN-2,
U6SN-1, U6F-6, U6FH-6

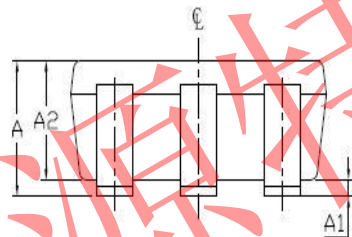

备注:

1. 标注单位:MM.
2. 引脚长度的测量点为引脚与塑封体接触点及引脚边缘最长处。
3. 塑封体测量尺寸不包括毛刺及金属毛刺,另塑封体毛刺及金属毛刺长度不超过0.25mm.
4. 引脚平面度控制小于0.1mm.
5. 印字面向上进行读取时, PIN1 位于左下方(参考图解).
6. PIN1的标记最小为 \varnothing 0.3mm, 并位于PIN1脚位上方.
7. 考文献: JEDECT0236-VARIATION AB.