



P-Channel Enhancement Mode Power MOSFET **MX3415L**

## DESCRIPTION

The MX3415L uses advanced trench technology to provide excellent  $R_{DS(ON)}$ , low gate charge and operation with gate voltages as low as -2.5V. This device is suitable for use as a load switch applications.

## GENERAL FEATURES

- $V_{DS}=-20V$ ,  $I_D=-4A$   
 $R_{DS(ON)}(Typ.)=42m\Omega$  @  $V_{GS}=-2.5V$   
 $R_{DS(ON)}(Typ.)=32m\Omega$  @  $V_{GS}=-4.5V$
- High Power and current handling capability
- Lead free product is acquired
- ESD Rating 4000V HBM

## APPLICATION

- PWM applications
- Load switch
- Power management

## PINOUT

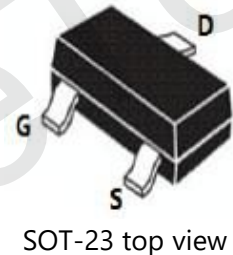
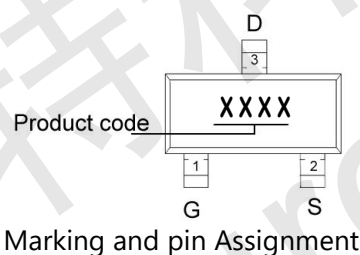
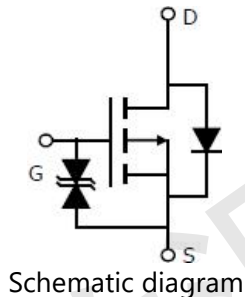

## ORDERING INFORMATION

Part Number	Storage Temperature	Package	Devices Per Reel
MX3415L	-55°C to 150°C	SOT-23	3000

## ABSOLUTE MAXIMUM RATINGS ( $T_A=25^\circ C$ unless otherwise noted)

Parameter	Symbol	Limit	Unit
Drain-Source Voltage	$V_{DS}$	-20	V
Gate-Source Voltage	$V_{GS}$	$\pm 10$	V
Drain Current-Continuous ( $T_C=25^\circ C$ )	$I_D$	-4	A
Pulsed Drain Current <sup>(Note1)</sup>	$I_{DM}$	-30	A
Maximum Power Dissipation ( $T_C=25^\circ C$ )	$P_D$	1.4	W
Operating Junction and Storage Temperature Range	$T_J, T_{STG}$	-55 to 150	$^\circ C$

## THERMAL RESISTANCE

Thermal Resistance, Junction-to-Ambient	$R_{\theta JA}$	90	$^\circ C/W$
---	-----------------	----	--------------

Note 1. Repetitive Rating: Pulse width limited by maximum junction temperature.



P-Channel Enhancement Mode Power MOSFET **MX3415L**



**ELECTRICAL CHARACTERISTICS** ( $T_A=25^\circ\text{C}$  unless otherwise noted)

Parameter	Symbol	Conditions	Min	Typ	Max	Unit
-----------	--------	------------	-----	-----	-----	------

**On/Off Characteristics**

Drain-Source Breakdown Voltage	$BV_{DSS}$	$V_{GS}=0V, I_D=-250\mu A$	-20	-	-	V
Zero Gate Voltage Drain Current	$I_{DSS}$	$V_{DS}=-20V, V_{GS}=0V$	-	-	-1	$\mu A$
Gate-Body Leakage Current	$I_{GSS}$	$V_{GS}=\pm 10V, V_{DS}=0V$	-	-	$\pm 10$	$\mu A$
Gate Threshold Voltage	$V_{GS(th)}$	$V_{DS}=V_{GS}, I_D=-250\mu A$	-0.45	-0.65	-1.1	V
Drain-Source On-State Resistance	$R_{DS(ON)}$	$V_{GS}=-2.5V, I_D=-4A$	-	42	58	$m\Omega$
		$V_{GS}=-4.5V, I_D=-4A$	-	32	42	$m\Omega$

**Dynamic Characteristics**

Forward Transconductance	$g_{FS}$	$V_{DS}=-5V, I_D=-4A$	-	12	-	S
Input Capacitance	$C_{iss}$	$V_{DS}=-10V, V_{GS}=0V, F=1.0MHz$	-	1084	-	$\mu F$
Output Capacitance	$C_{oss}$		-	140	-	$\mu F$
Reverse Transfer Capacitance	$C_{rss}$		-	111	-	$\mu F$
Total Gate Charge	$Q_g$	$V_{DS}=-10V, I_D=-4A, V_{GS}=-4.5V$	-	11	-	nC
Gate-Source Charge	$Q_{gs}$		-	1.4	-	nC
Gate-Drain Charge	$Q_{gd}$		-	3.4	-	nC

**Switching Characteristics** (Note4)

Turn-on Delay Time	$t_{d(on)}$	$V_{DS}=-10V, V_{GS}=-4.5V, R_L=2.5\Omega, R_G=3\Omega$	-	26	-	nS
Turn-on Rise Time	$t_r$		-	19	-	nS
Turn-Off Delay Time	$t_{d(off)}$		-	51	-	nS
Turn-Off Fall Time	$t_f$		-	62	-	nS

**Drain-Source Diode Characteristics**

Source-Drain Current(Body Diode)	$I_{SD}$		-	-	-4	A
Diode Forward Voltage (Note 3)	$V_{SD}$	$V_{GS}=0V, I_S=-4A$	-	-	-1.2	V



## TEST CIRCUIT

### 1、Gate Charge Test Circuit

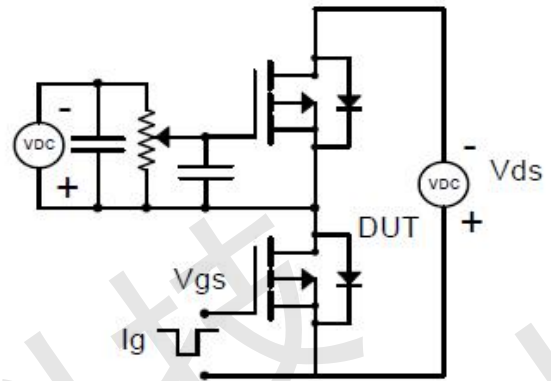
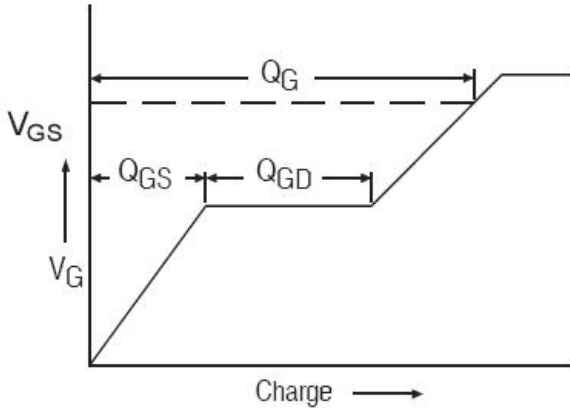

### 2、Switch Time Test Circuit and Switching Waveforms

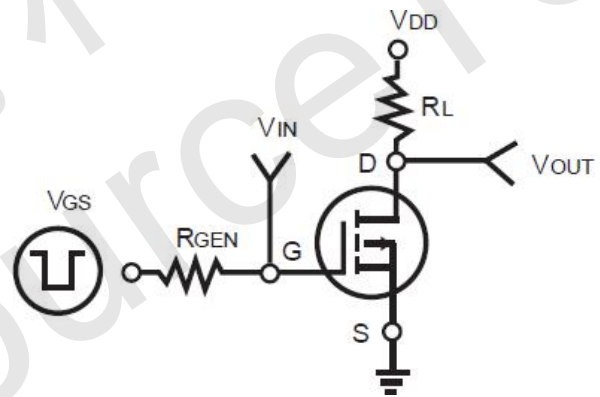
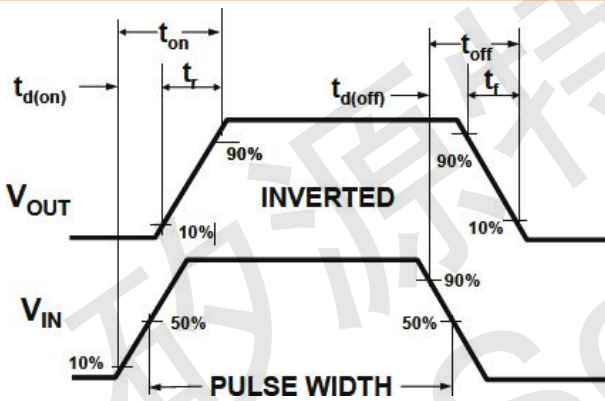



**TYPICAL ELECTRICAL AND THERMAL CHARACTERISTICS**

**Figure 1. Power Dissipation**

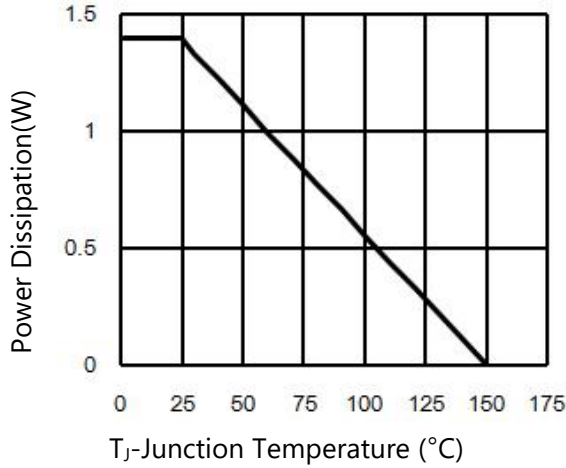

**Figure 2. Drain Current**

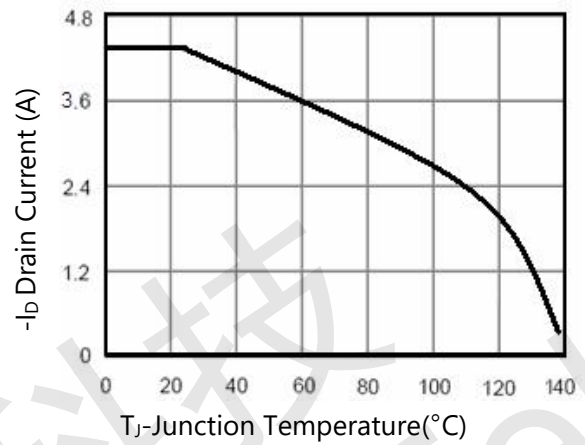

**Figure 3. Output Characteristics**

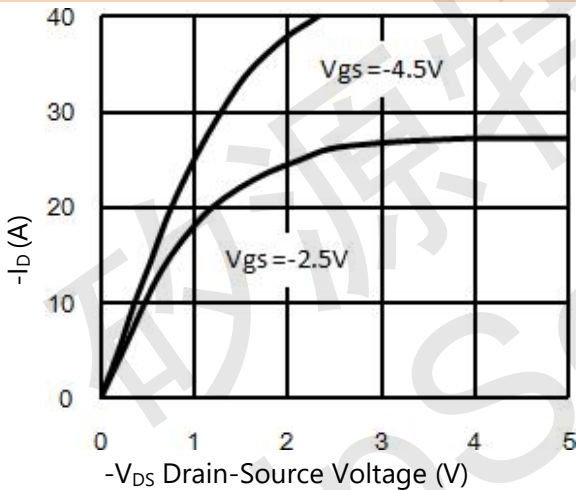

**Figure 4. Transfer Characteristics**

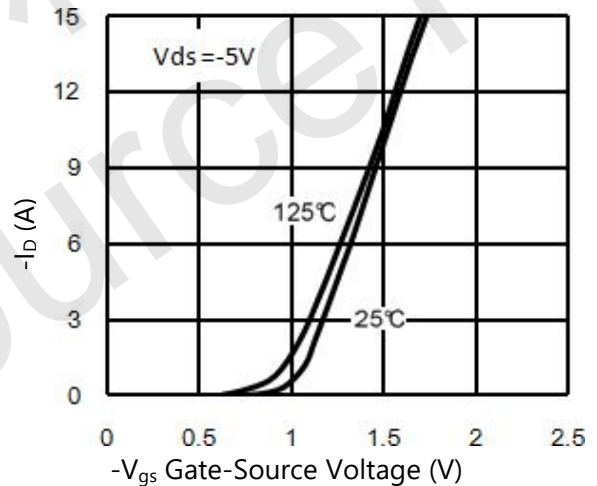

**Figure 5. V<sub>GS(th)</sub> vs Junction Temperature**

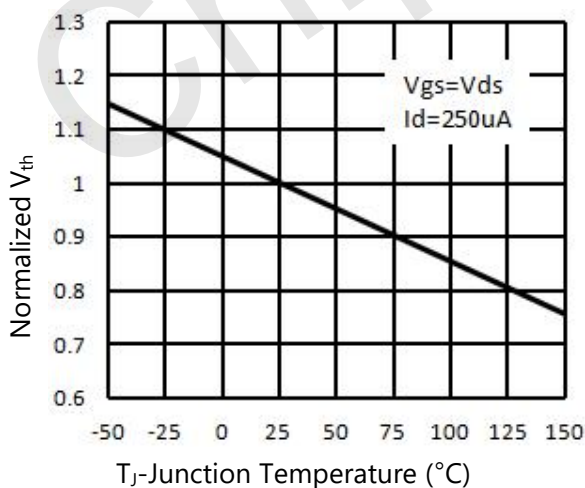

**Figure 6. R<sub>DS(ON)</sub> vs Junction Temperature**

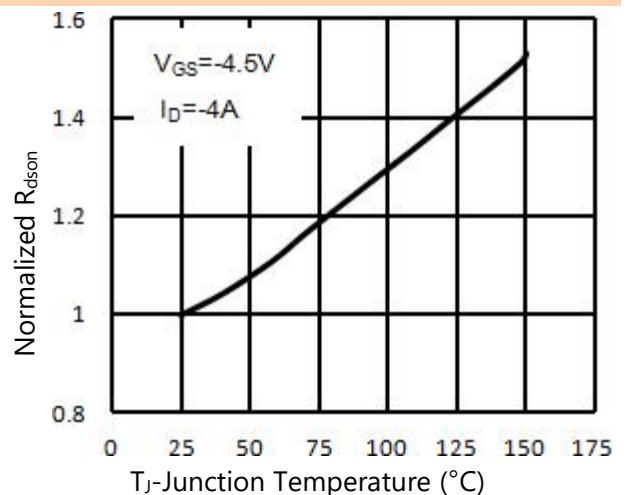



## TYPICAL ELECTRICAL AND THERMAL CHARACTERISTICS

Figure 7. Gate Charge Waveforms

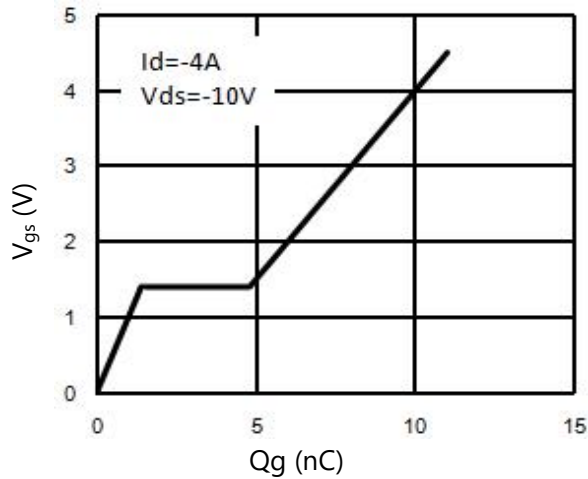

Figure 8. Capacitance

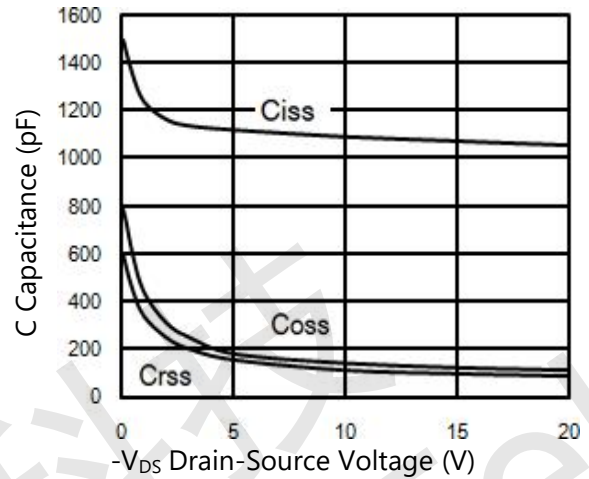

Figure 9. Body-Diode Characteristics

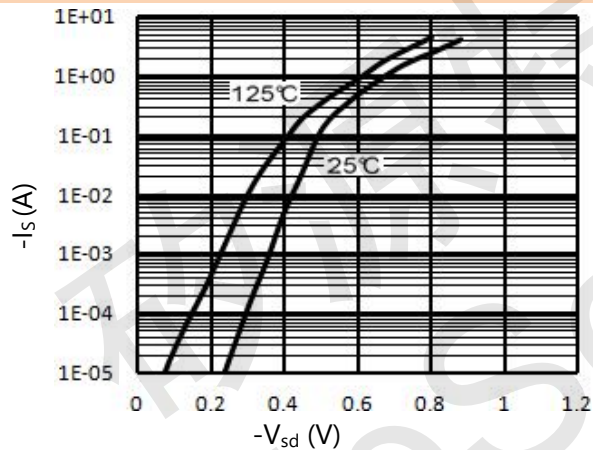
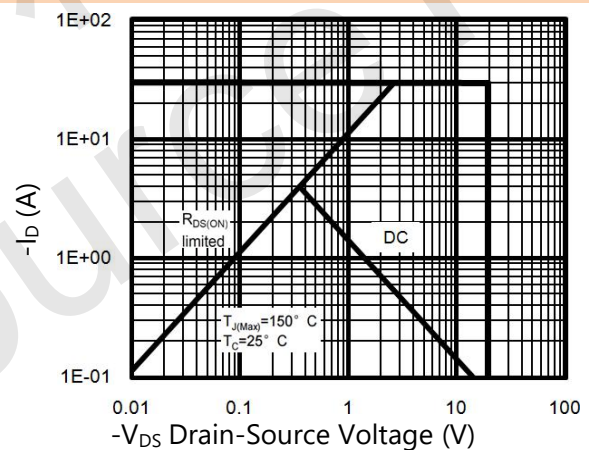

Figure 10. Maximum Safe Operating Area





 **PACKAGE INFORMATION**

SOT-23

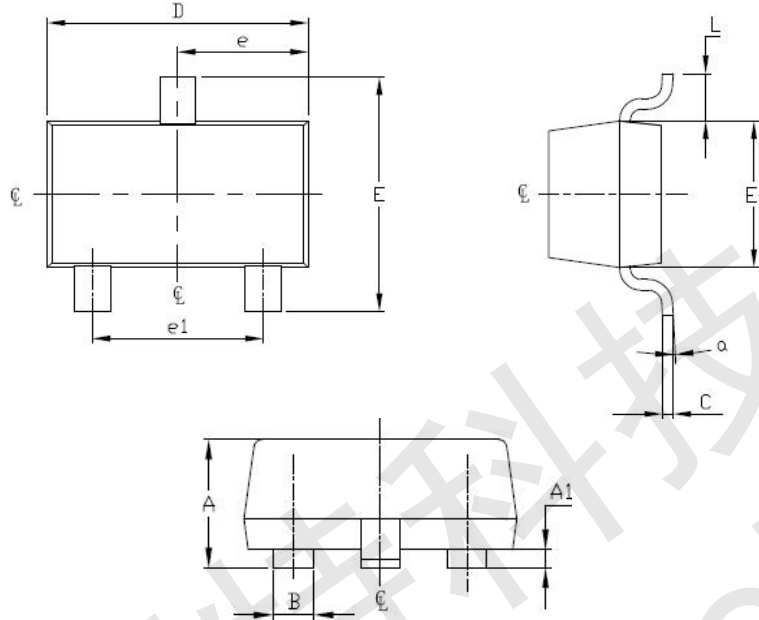

Symbol	Dimensions InMillimeters		
	Min.	Typ.	Max.
A	0.9	1.0	1.1
A1	0.00	0.06	0.1
B	0.3	0.4	0.5
C	0.07	0.09	0.18
D	2.8	2.9	3.04
E	2.1	2.33	2.64
E1	1.2	1.3	1.4
e	1.4	1.45	1.5
e1	1.80	1.90	2.00
L	0.45	0.54	0.63
$\alpha$	0°	2.5°	7°