



P-Channel Enhancement Mode Power MOSFET **MX2301**

DESCRIPTION

The MX2301 uses advanced trench technology to provide excellent $R_{DS(ON)}$ and low gate charge. It can be used in a wide variety of applications.

GENERAL FEATURES

- $V_{DS}=-20V$, $I_D=-3A$
 $R_{DS(ON)}(Typ.)=110m\Omega$ @ $V_{GS}=-2.5V$
 $R_{DS(ON)}(Typ.)=85m\Omega$ @ $V_{GS}=-4.5V$
- High Power and current handing capability
- Lead free product is acquired
- Surface Mount Package

APPLICATION

- PWM applications
- Load switch
- Power management

PINOUT

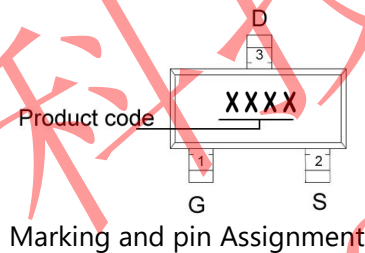
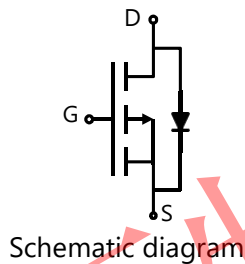

ORDERING INFORMATION

Part Number	Storage Temperature	Package	Devices Per Reel
MX2301	-55°C to 150°C	SOT-23	3000

ABSOLUTE MAXIMUM RATINGS ($T_A=25^\circ C$ unless otherwise noted)

Parameter	Symbol	Limit	Unit
Drain-Source Voltage	V_{DS}	-20	V
Gate-Source Voltage	V_{GS}	± 12	V
Drain Current-Continuous	I_D	-3	A
Pulsed Drain Current ^(Note1)	I_{DM}	-10	A
Maximum Power Dissipation	P_D	1	W
Operating Junction and Storage Temperature Range	T_J, T_{STG}	-55 to 150	$^\circ C$

THERMAL RESISTANCE

Thermal Resistance, Junction-to-Ambient ^(Note2)	$R_{\theta JA}$	125	$^\circ C/W$
--	-----------------	-----	--------------

Note 1. Repetitive Rating: Pulse width limited by maximum junction temperature.

Note 2. Surface Mounted on FR4 Board, $t \leq 10$ sec.



P-Channel Enhancement Mode Power MOSFET **MX2301**



ELECTRICAL CHARACTERISTICS ($T_A=25^\circ\text{C}$ unless otherwise noted)

Parameter	Symbol	Conditions	Min	Typ	Max	Unit
Off Characteristics						
Drain-Source Breakdown Voltage	BV_{DSS}	$V_{GS}=0V, I_D=-250\mu A$	-20	-	-	V
Zero Gate Voltage Drain Current	I_{DSS}	$V_{DS}=-20V, V_{GS}=0V$	-	-	-1	μA
Gate-Body Leakage Current	I_{GSS}	$V_{GS}=\pm 12V, V_{DS}=0V$	-	-	± 100	nA
On Characteristics (Note 3)						
Gate Threshold Voltage	$V_{GS(th)}$	$V_{DS}=V_{GS}, I_D=-250\mu A$	-0.45	-0.7	-1	V
Drain-Source On-State Resistance	$R_{DS(ON)}$	$V_{GS}=-2.5V, I_D=-2A$	-	110	140	m Ω
		$V_{GS}=-4.5V, I_D=-2.5A$	-	85	110	m Ω
Forward Transconductance	g_{FS}	$V_{DS}=-5V, I_D=-2.8A$	-	9.5	-	S
Dynamic Characteristics (Note4)						
Input Capacitance	C_{iss}	$V_{DS}=-10V, V_{GS}=0V,$ $F=1.0MHz$	-	405	-	pF
Output Capacitance	C_{oss}		-	75	-	pF
Reverse Transfer Capacitance (Note4)	C_{rss}		-	55	-	pF
Switching Characteristics						
Turn-on Delay Time	$t_{d(on)}$	$V_{DD}=-10V, I_D=-1A,$ $R_L=1\Omega,$ $V_{GS}=-4.5V, R_G=3\Omega$	-	11	-	nS
Turn-on Rise Time	t_r		-	35	-	nS
Turn-Off Delay Time	$t_{d(off)}$		-	30	-	nS
Turn-Off Fall Time	t_f		-	10	-	nS
Total Gate Charge	Q_g	$V_{DS}=-10V, I_D=-3A,$ $V_{GS}=-4.5V$	-	3.3	-	nC
Gate-Source Charge	Q_{gs}		-	0.7	-	nC
Gate-Drain Charge	Q_{gd}		-	1.3	-	nC
Drain-Source Diode Characteristics						
Diode Forward Voltage (Note 3)	V_{SD}	$V_{GS}=0V, I_S=-1A$	-	-	-1.2	V
Diode Forward Current (Note 2)	I_S		-	-	-1.3	A

Note 2. Surface Mounted on FR4 Board, $t \leq 10$ sec.

Note 3. Pulse Test: Pulse Width $\leq 300\mu s$, Duty Cycle $\leq 2\%$.

Note 4. Guaranteed by design, not subject to product.



P-Channel Enhancement Mode Power MOSFET **MX2301**

TYPICAL ELECTRICAL AND THERMAL CHARACTERISTICS

Figure 1. Switching Test Circuit

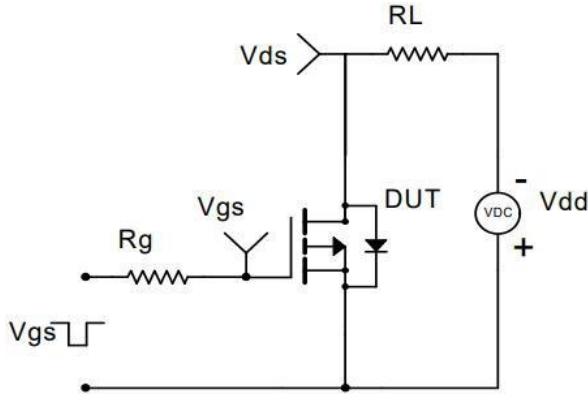

Figure 2. Switching Waveform

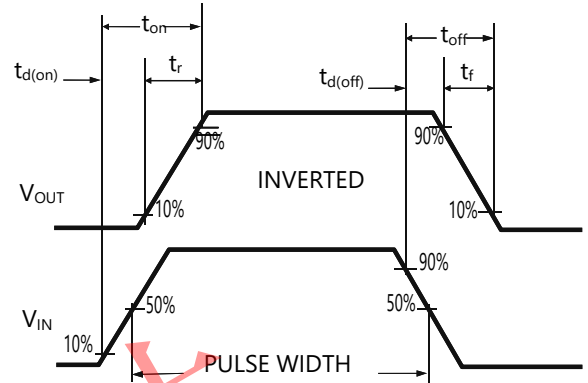

Figure 3. Power De-rating

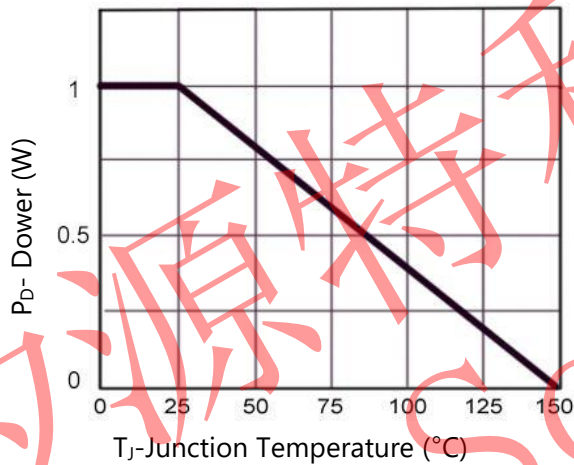

Figure 4. Drain Current

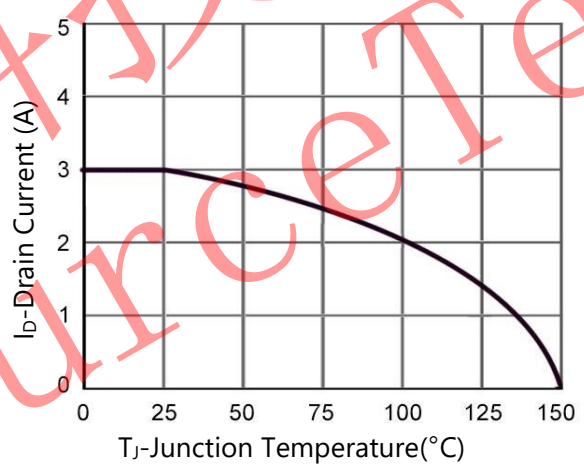

Figure 5. Output Characteristics

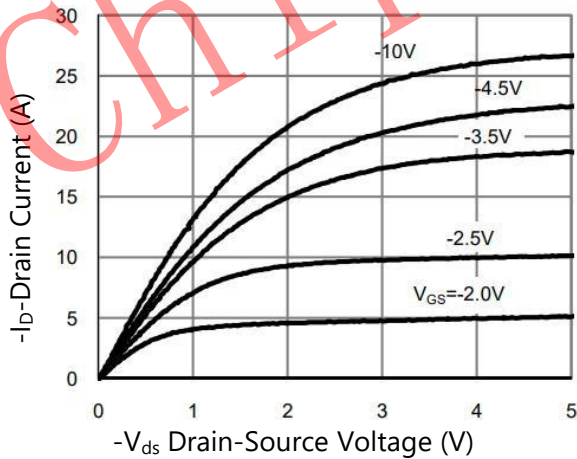
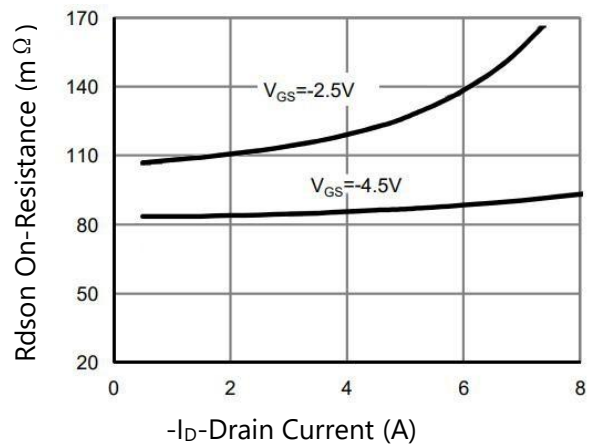

Figure 6. R_{dson} vs Drain Current





P-Channel Enhancement Mode Power MOSFET **MX2301**

TYPICAL ELECTRICAL AND THERMAL CHARACTERISTICS

Figure 7. Transfer Characteristics

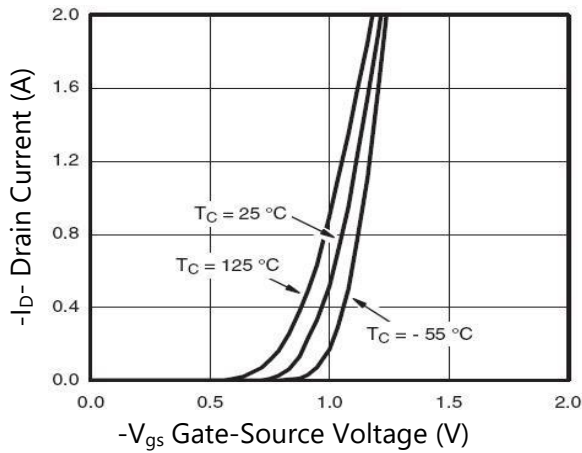

Figure 8. Drain-Source On-Resistance

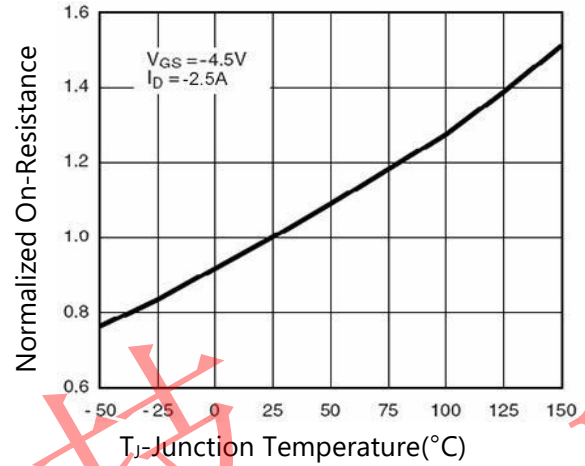

Figure 9. Rdson vs Vgs

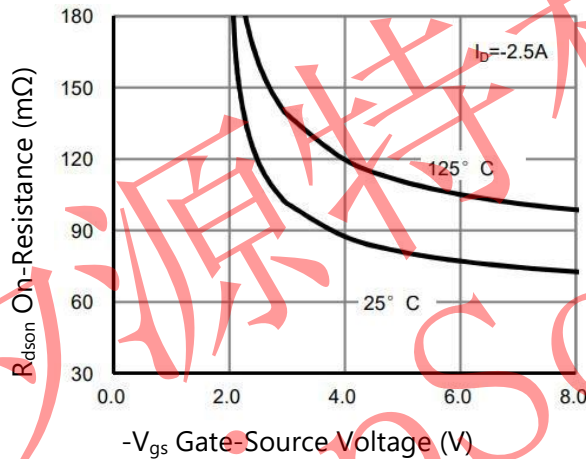

Figure 10. Capacitance vs VDS

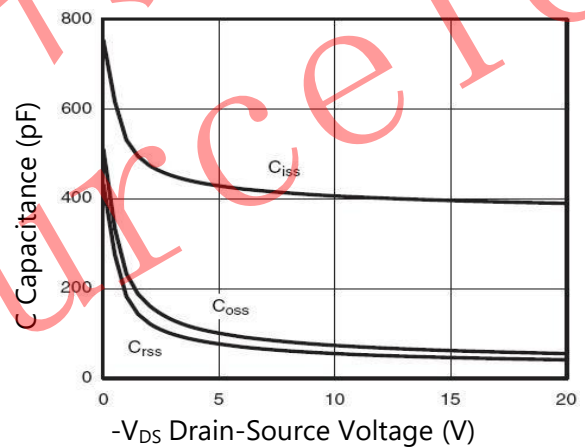

Figure 11. Gate Charge

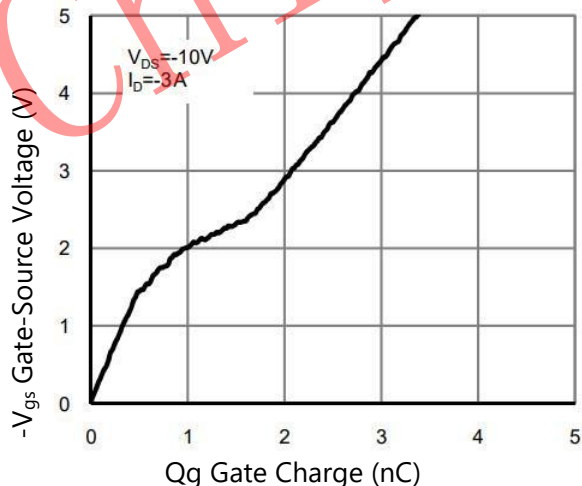
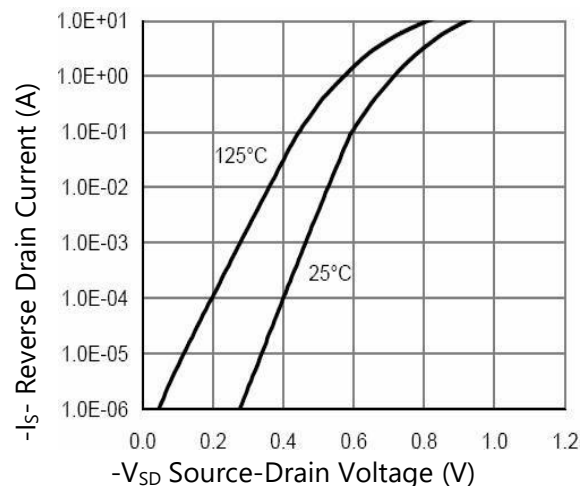

Figure 12. Source- Drain Diode Forward





P-Channel Enhancement Mode Power MOSFET **MX2301**

TYPICAL ELECTRICAL AND THERMAL CHARACTERISTICS

Figure 13. Safe Operation Area

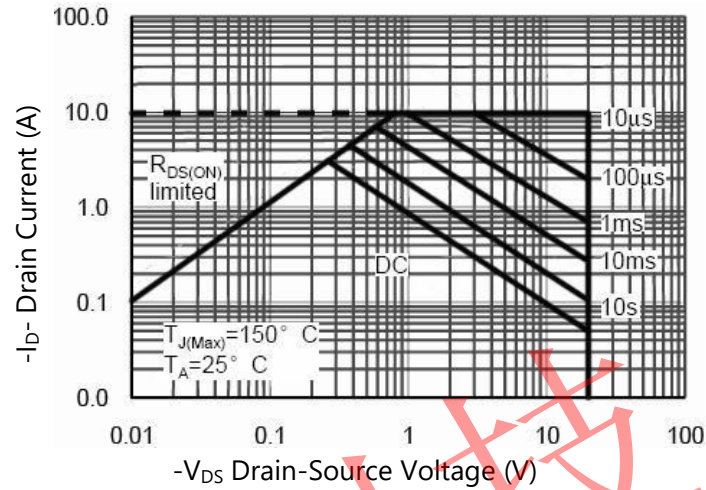
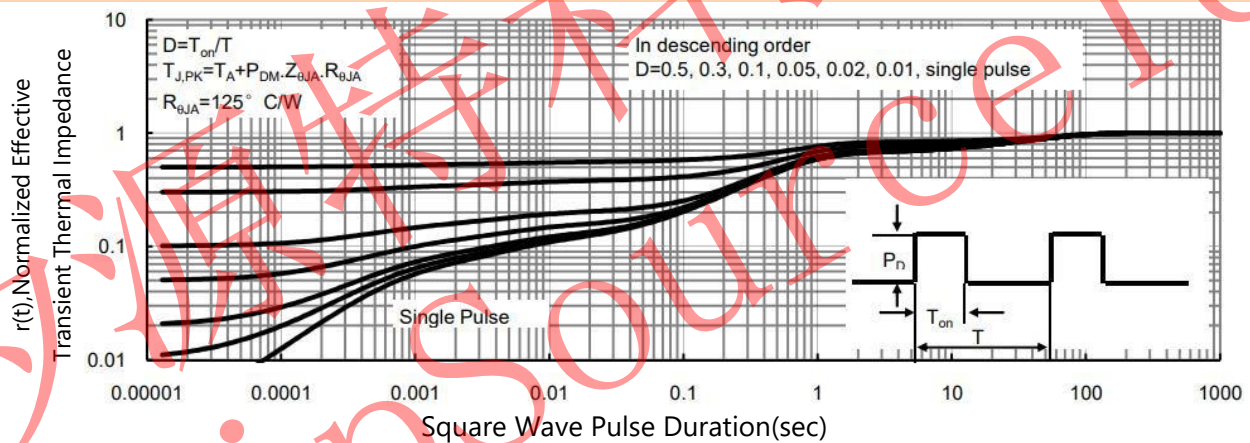

Figure 14. Normalized Maximum Transient Thermal Impedance





PACKAGE INFORMATION

SOT-23

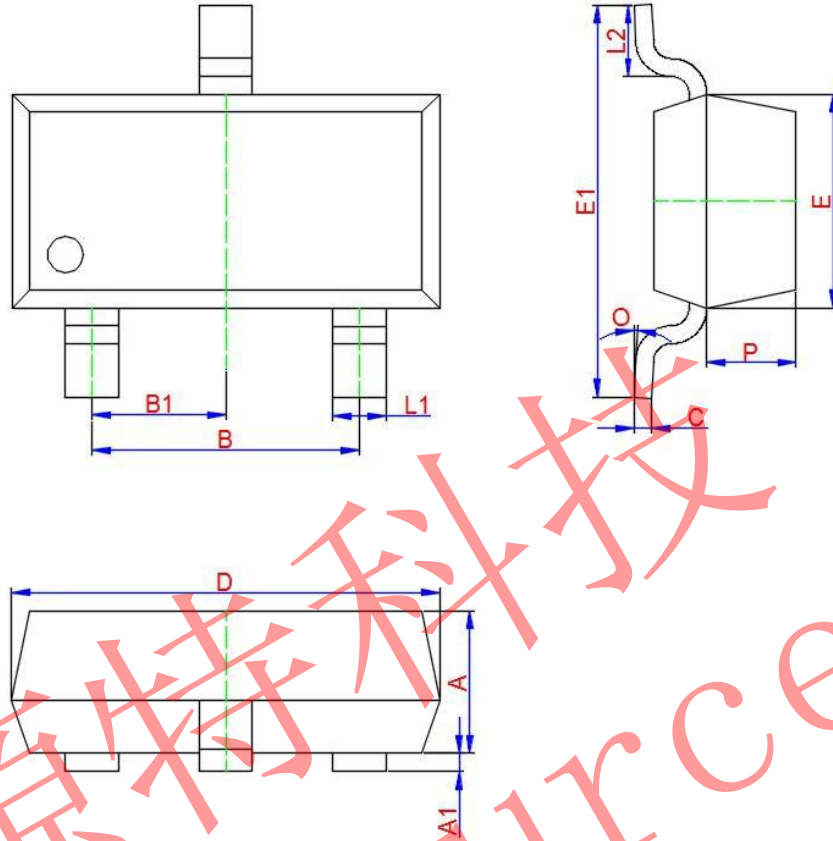

Symbol	Dimensions In Millimeters		
	Min.	Typ.	Max.
A	0.900	1.000	1.100
A1	0.000	0.050	0.100
L1	0.300	0.400	0.500
C	0.100	0.110	0.120
D	2.800	2.900	3.000
E	1.250	1.300	1.350
E1	2.250	2.400	2.550
B	1.800	1.900	2.000
B1	0.950 TYP.		
L2	0.200	0.350	0.450
P	0.550	0.575	0.600
O	0°	4°	8°