



### N-Channel Enhancement Mode Power MOSFET

#### Description

The MX2300C uses advanced trench technology to provide excellent  $R_{DS(ON)}$ , low gate charge and operation with gate voltages as low as 2.5V.

This device is suitable for use as a load switch or in PWM applications.

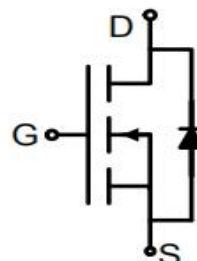

#### General Features

- ◆  $V_{DS} = 20V$ ,  $I_D = 2.5A$
- ◆  $R_{DS(ON)}$ (Typ.)  $52m\Omega$  @  $V_{GS} = 4.5V$
- ◆  $R_{DS(ON)}$ (Typ.)  $72m\Omega$  @  $V_{GS} = 2.5V$
- ◆ High power and current handling capability
- ◆ Lead free product is acquired
- ◆ Surface mount package

#### Schematic diagram

#### Application

- ◆ PWM applications
- ◆ Load switch
- ◆ Power management

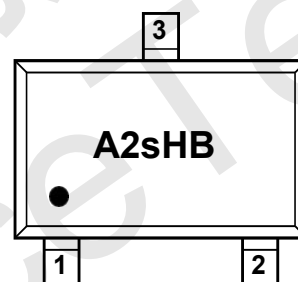

#### Marking and pin assignment



SOT-23 top view

#### Absolute Maximum Ratings (TA=25°C unless otherwise noted)

parameter	symbol	limit	unit
Drain-source voltage	$V_{DS}$	20	V
Gate-source voltage	$V_{GS}$	$\pm 12$	V
Drain current-continuous <sup>a</sup> @Tj=125°C -pulse <sup>b</sup>	$I_D$	2.5	A
	$I_{DM}$	5	A
Maximum power dissipation	$P_D$	0.35	W
Operating junction Temperature range	$T_j$	-55—150	°C



### Electrical Characteristics (TA=25°C unless otherwise noted)

Symbol	Parameter	Conditions	Min	Typ	Max	Unit
<b>On/Off States</b>						
BV <sub>DSS</sub>	Drain-Source Breakdown Voltage	V <sub>GS</sub> =0V, I <sub>D</sub> =250μA	20			V
I <sub>DSS</sub>	Zero Gate Voltage Drain Current	V <sub>DS</sub> =20V, V <sub>GS</sub> =0V	-	-	1	μA
I <sub>GSS</sub>	Gate-Body Leakage Current	V <sub>GS</sub> =±12V, V <sub>DS</sub> =0V			±100	nA
V <sub>GS(th)</sub>	Gate Threshold Voltage	V <sub>DS</sub> =V <sub>GS</sub> , I <sub>D</sub> =250μA	0.5	0.7	1.2	V
g <sub>FS</sub>	Forward Transconductance	V <sub>DS</sub> =5V, I <sub>D</sub> =2.1A	-	6.5	-	S
R <sub>DS(ON)</sub>	Drain-Source On-State Resistance	V <sub>GS</sub> =4.5V, I <sub>D</sub> =2.1A	-	52	70	mΩ
		V <sub>GS</sub> =2.5V, I <sub>D</sub> =2.1A	-	72	95	mΩ
<b>Dynamic Characteristics</b>						
C <sub>iss</sub>	Input Capacitance	V <sub>DS</sub> =10V, V <sub>GS</sub> =0V, f=1.0MHz	-	430	-	pF
C <sub>oss</sub>	Output Capacitance		-	78	-	pF
C <sub>rss</sub>	Reverse Transfer Capacitance		-	46	-	pF
<b>Switching Times</b>						
t <sub>d(on)</sub>	Turn-on Delay Time	V <sub>DD</sub> =10V, I <sub>D</sub> =2.1A, R <sub>L</sub> =2.8Ω V <sub>GS</sub> =4.5V, R <sub>G</sub> =6Ω	-	11		nS
t <sub>r</sub>	Turn-on Rise Time		-	42		nS
t <sub>d(off)</sub>	Turn-Off Delay Time		-	13		nS
t <sub>f</sub>	Turn-Off Fall Time		-	10		nS
Q <sub>g</sub>	Total Gate Charge	V <sub>DS</sub> =10V, I <sub>D</sub> =3A, V <sub>GS</sub> =4.5V	-	4		nC
Q <sub>gs</sub>	Gate-Source Charge		-	0.7	-	nC
Q <sub>gd</sub>	Gate-Drain Charge		-	1.2	-	nC
<b>Source-Drain Diode Characteristics</b>						
I <sub>SD</sub>	Source-Drain Current(Body Diode)		-	-	2.0	A
V <sub>SD</sub>	Forward on Voltag	V <sub>GS</sub> =0V, I <sub>S</sub> =1A	-	0.75	1.2	V

### Thermal Characteristic

Thermal Resistance, Junction-to-Ambient (Note 2)	R <sub>θJA</sub>	125	°C/W
--	------------------	-----	------

#### Notes:

- surface mounted on FR4 board, t<sub>s</sub>≤10sec
- pulse test: pulse width≤300μs, duty≤2%
- guaranteed by design, not subject to production testing



### Typical Performance Characteristics

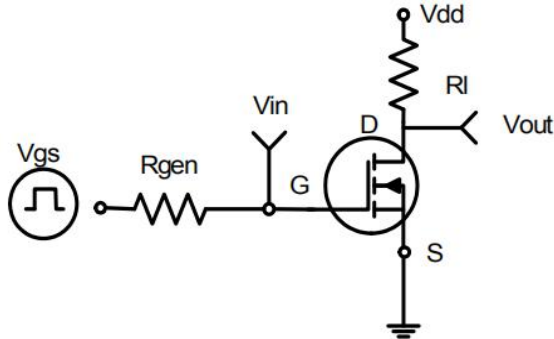

Figure 1: Switching Test Circuit

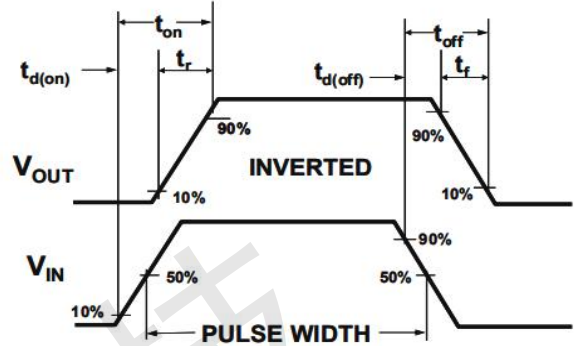

Figure 2: Switching Waveforms

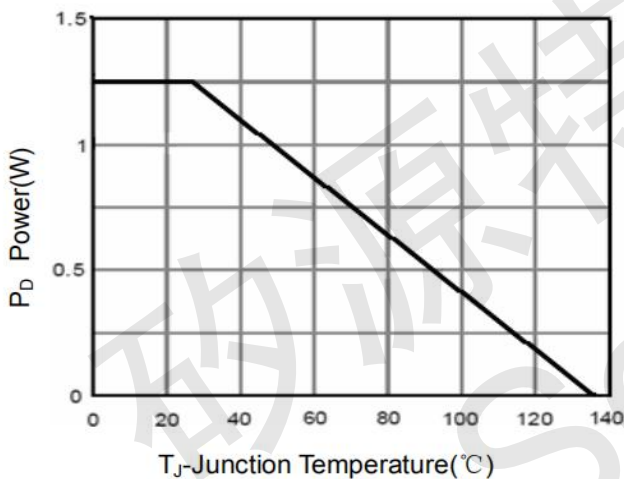

Figure 3 Power Dissipation

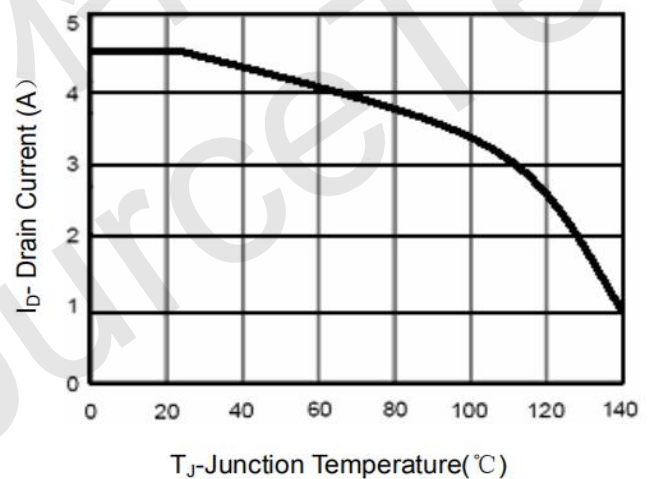

Figure 4 Drain Current

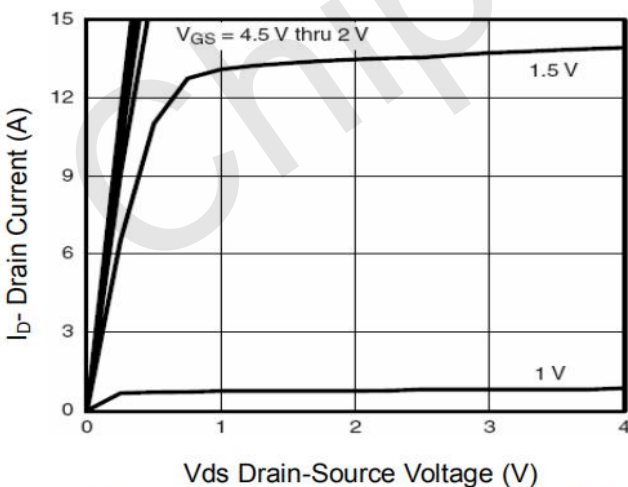

Figure 5 Output CHARACTERISTICS

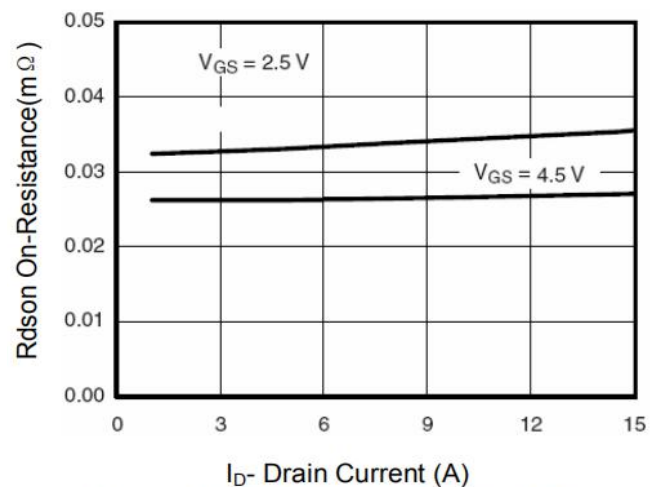

Figure 6 Drain-Source On-Resistance

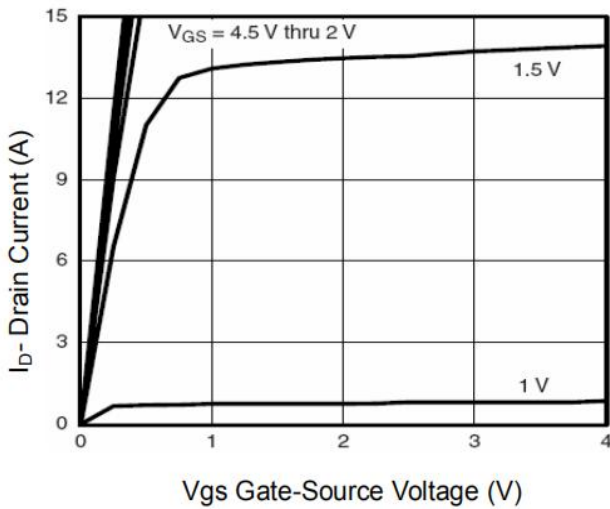

Figure 7 Transfer Characteristics

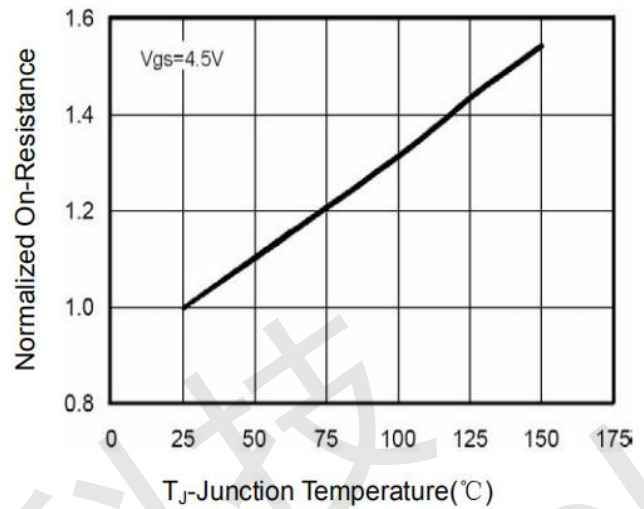

Figure 8 Drain-Source On-Resistance

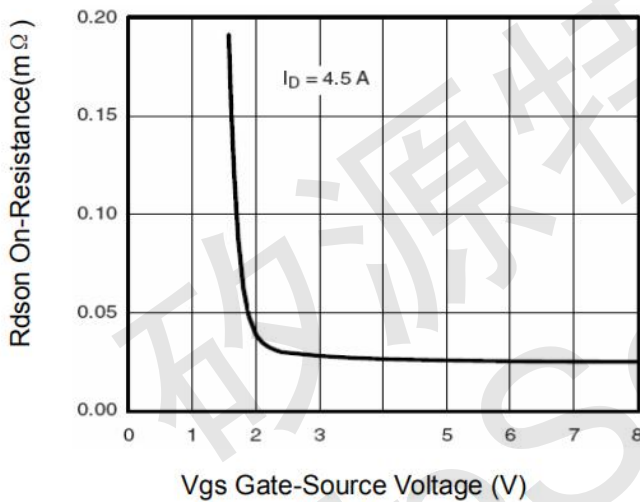

Figure 9 Rdson vs Vgs

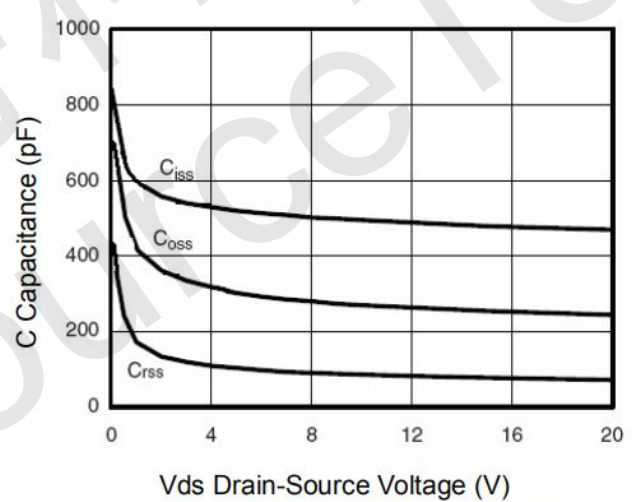

Figure 10 Capacitance vs Vds

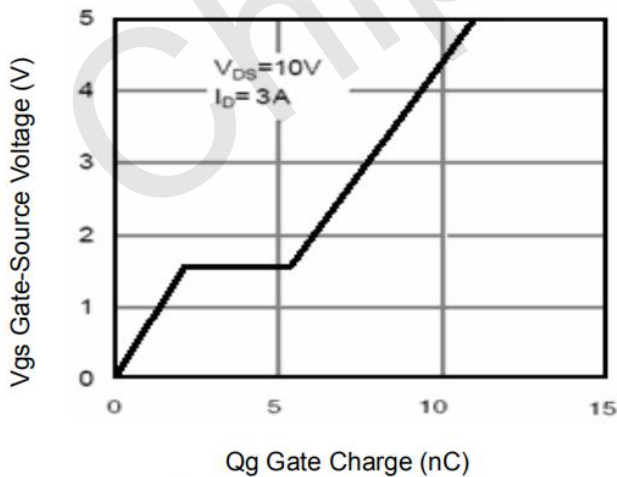

Figure 11 Gate Charge

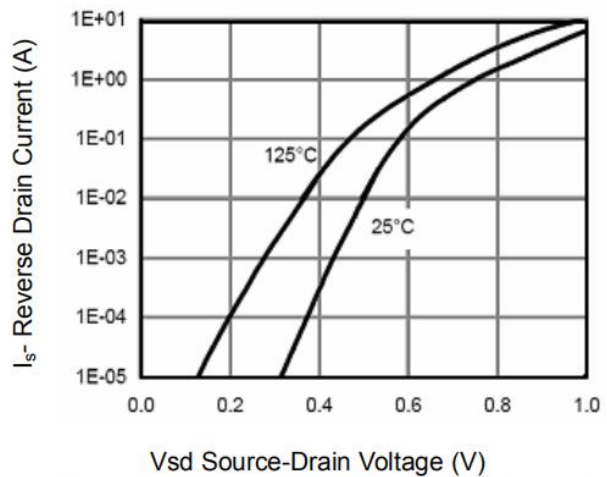

Figure 12 Source- Drain Diode Forward

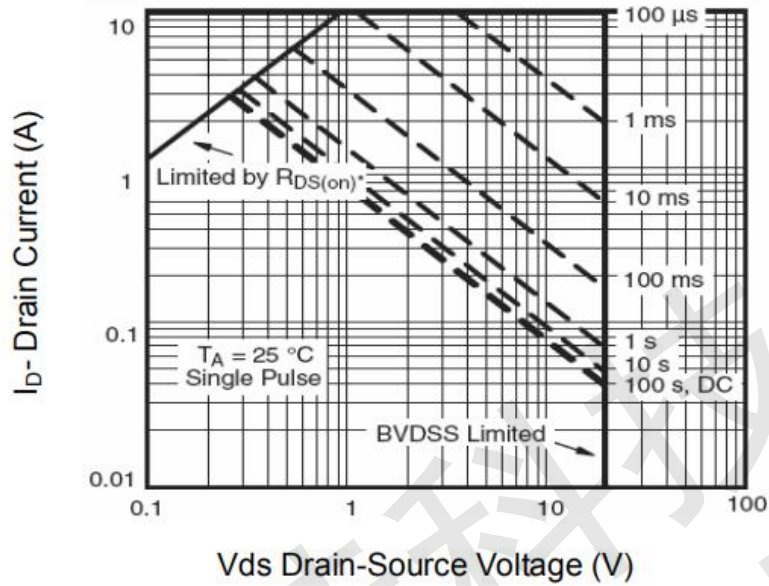

Figure 13 Safe Operation Area

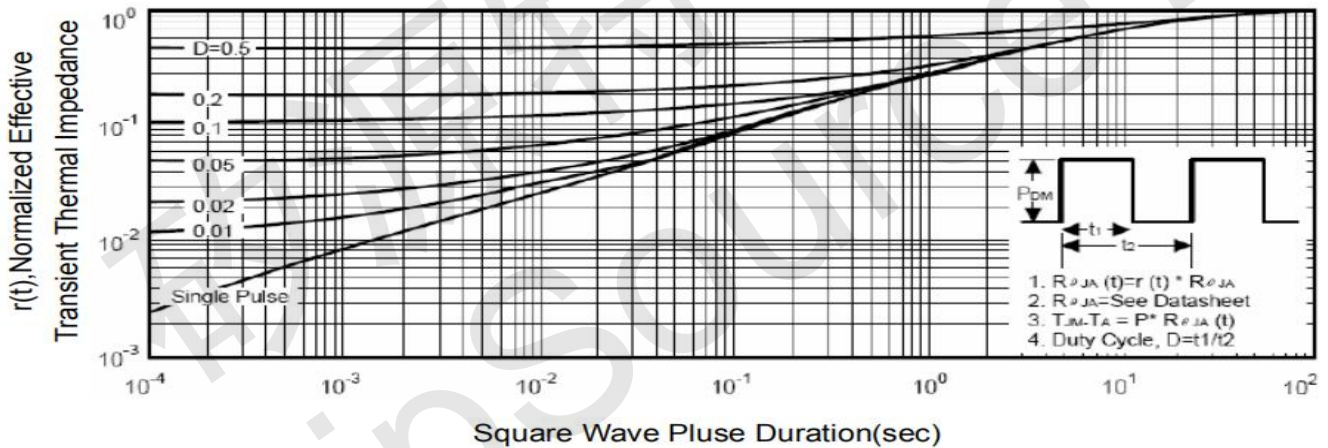
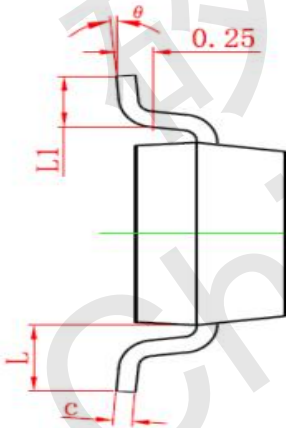
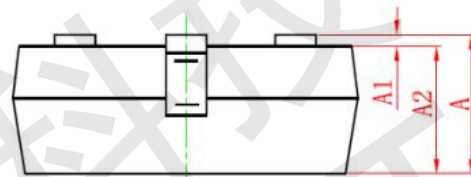
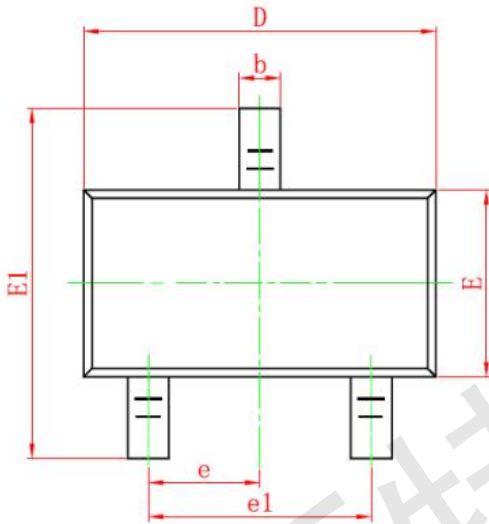

Figure 14 Normalized Maximum Transient Thermal Impedance



## SOT-23 PACKAGE INFORMATION

Dimensions in Millimeters (UNIT:mm)



Symbol	Dimensions in Millimeters	
	MIN.	MAX.
A	0.900	1.150
A1	0.000	0.100
A2	0.900	1.050
b	0.300	0.500
c	0.080	0.150
D	2.800	3.000
E	1.200	1.400
E1	2.250	2.550
e	0.950TYP	
e1	1.800	2.000
L	0.550REF	
L1	0.300	0.500
$\theta$	0°	8°

### NOTES

1. All dimensions are in millimeters.
2. Tolerance  $\pm 0.10\text{mm}$  (4 mil) unless otherwise specified
3. Package body sizes exclude mold flash and gate burrs. Mold flash at the non-lead sides should be less than 5 mils.
4. Dimension L is measured in gauge plane.
5. Controlling dimension is millimeter, converted inch dimensions are not necessarily exact.