

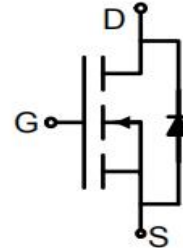

N-Channel Enhancement Mode Power MOSFET

Description

The MX2300 uses advanced trench technology to provide excellent $R_{DS(ON)}$, low gate charge and operation with gate voltages as low as 2.5V. This device is suitable for use as a load switch or in PWM applications.



Schematic diagram

General Features

- ◆ $V_{DS} = 20V$, $I_D = 4.5A$
- ◆ $R_{DS(ON)}(Typ.) 27m\Omega @ V_{GS}=4.5V$
- ◆ $R_{DS(ON)}(Typ.) 33m\Omega @ V_{GS}=2.5V$
- ◆ High power and current handling capability
- ◆ Lead free product is acquired
- ◆ Surface mount package

Application

- ◆ PWM applications
- ◆ Load switch
- ◆ Power management

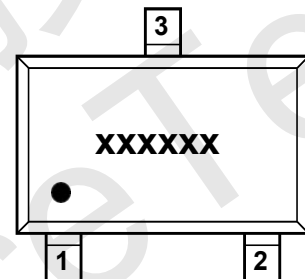

Marking and pin assignment



SOT-23 top view

Absolute Maximum Ratings (TA=25°C unless otherwise noted)

parameter	symbol	limit	unit
Drain-source voltage	V_{DS}	20	V
Gate-source voltage	V_{GS}	± 10	V
Drain current-continuous ^a @Tj=125°C -pulse ^b	I_D	4.5	A
	I_{DM}	13.5	A
Maximum power dissipation	P_D	1.25	W
Operating junction Temperature range	T_j	-55—150	°C



Electrical Characteristics (TA=25°C unless otherwise noted)

Symbol	Parameter	Conditions	Min	Typ	Max	Unit
On/Off States						
BV _{DSS}	Drain-Source Breakdown Voltage	V _{GS} =0V, I _D =250μA	20	22		V
I _{DSS}	Zero Gate Voltage Drain Current	V _{DS} =20V, V _{GS} =0V	-	-	1	μA
I _{GSS}	Gate-Body Leakage Current	V _{GS} =±10V, V _{DS} =0V			±100	nA
V _{GS(th)}	Gate Threshold Voltage	V _{DS} =V _{GS} , I _D =250μA	0.5	0.65	1.2	V
g _{FS}	Forward Transconductance	V _{DS} =10V, I _D =4A	-	10	-	S
R _{DS(ON)}	Drain-Source On-State Resistance	V _{GS} =4.5V, I _D =4.5A	-	27	33	mΩ
		V _{GS} =2.5V, I _D =4A	-	33	40	mΩ
Dynamic Characteristics						
C _{iss}	Input Capacitance	V _{DS} =8V, V _{GS} =0V, f=1.0MHz	-	500	-	pF
C _{oss}	Output Capacitance		-	300	-	pF
C _{rss}	Reverse Transfer Capacitance		-	140	-	pF
Switching Times						
t _{d(on)}	Turn-on Delay Time	V _{DD} =10V, I _D =1A, I _D =1A V _{GS} =4.5V, R _G =6Ω	-	20	40	nS
t _r	Turn-on Rise Time		-	18	40	nS
t _{d(off)}	Turn-Off Delay Time		-	60	108	nS
t _f	Turn-Off Fall Time		-	28	56	nS
Q _g	Total Gate Charge	V _{DS} =10V, I _D =3A, V _{GS} =4.5V	-	10	15	nC
Q _{gs}	Gate-Source Charge		-	2.3	-	nC
Q _{gd}	Gate-Drain Charge		-	2.9	-	nC
Source-Drain Diode Characteristics						
I _{SD}	Source-Drain Current(Body Diode)		-	-	1	A
V _{SD}	Forward on Voltag	V _{GS} =0V, I _S =1A	-	-	1.2	V

Notes:

- surface mounted on FR4 board, t_s≤10sec
- pulse test: pulse width≤300μs, duty≤2%
- guaranteed by design, not subject to production testing



Typical Performance Characteristics

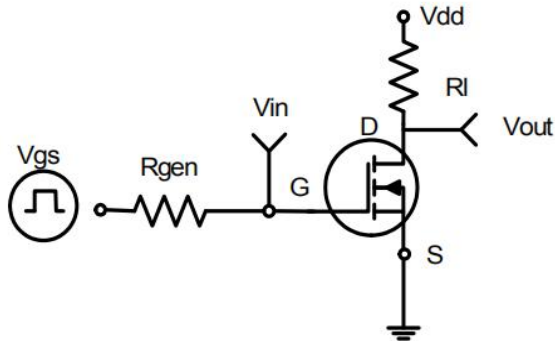

Figure 1: Switching Test Circuit

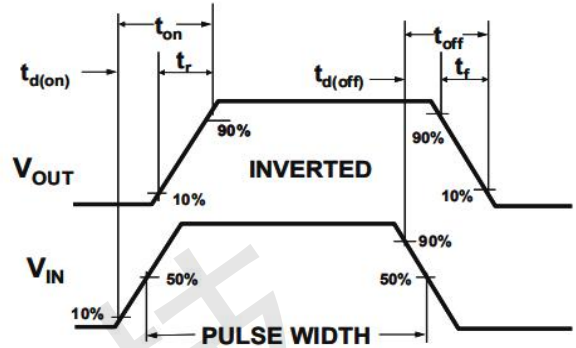

Figure 2: Switching Waveforms

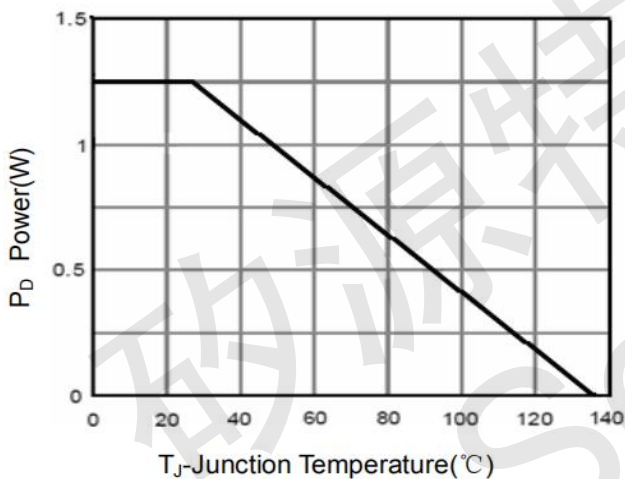

Figure 3 Power Dissipation

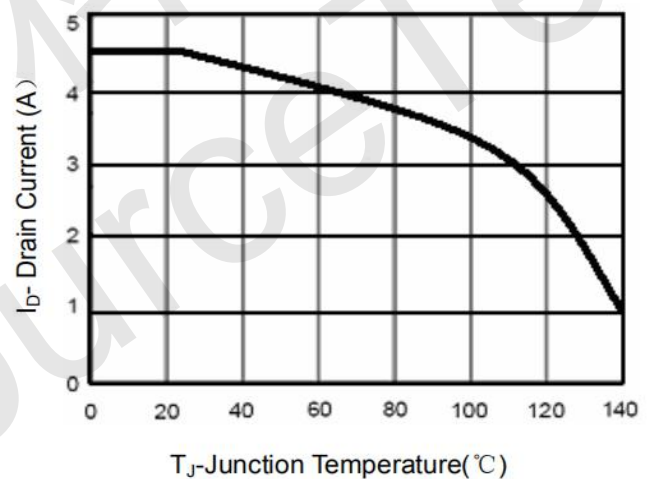

Figure 4 Drain Current

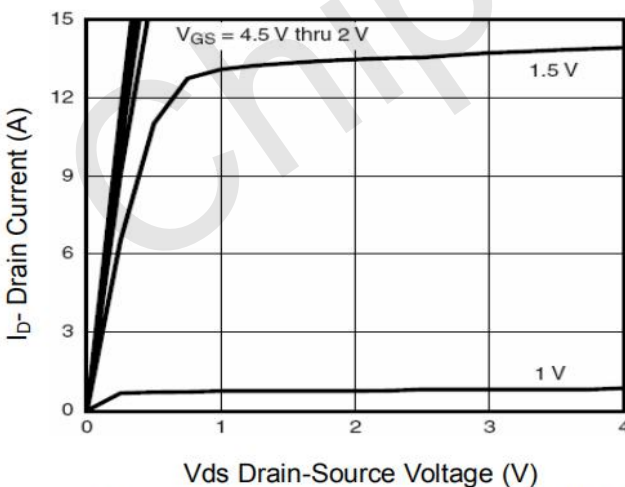

Figure 5 Output CHARACTERISTICS

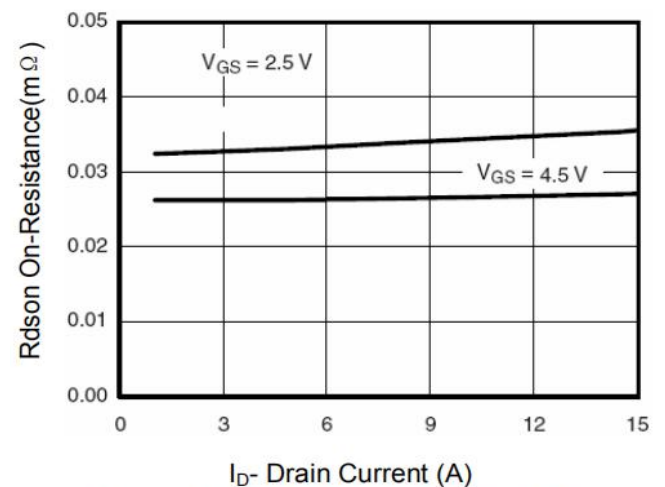
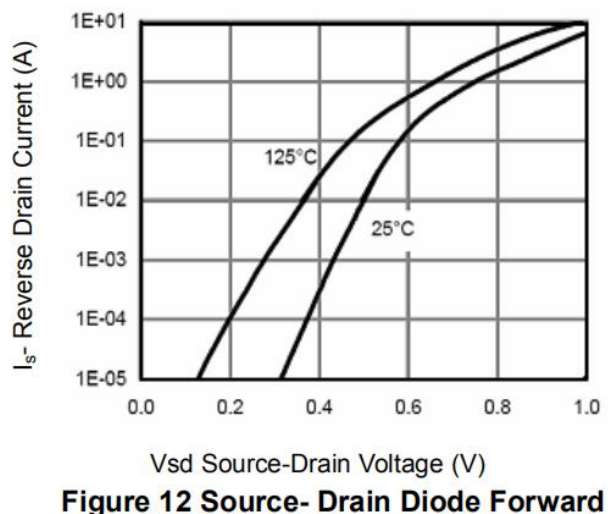
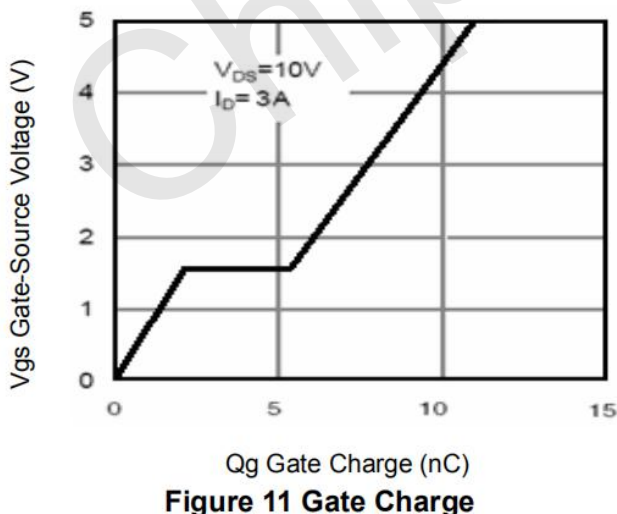
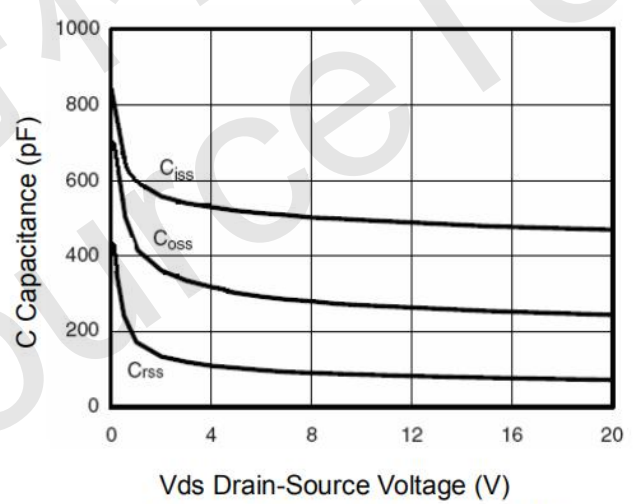
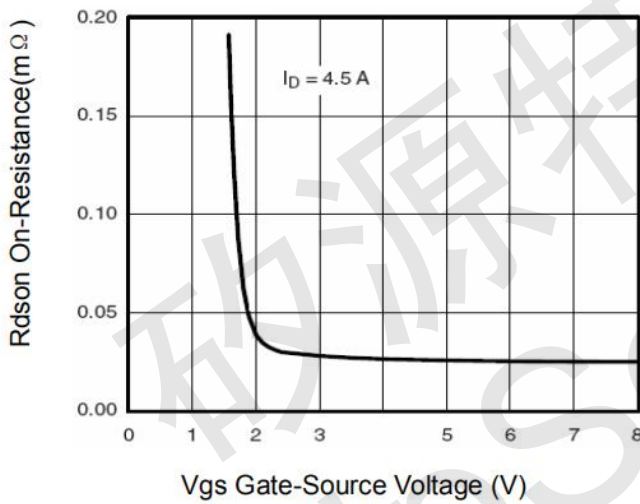
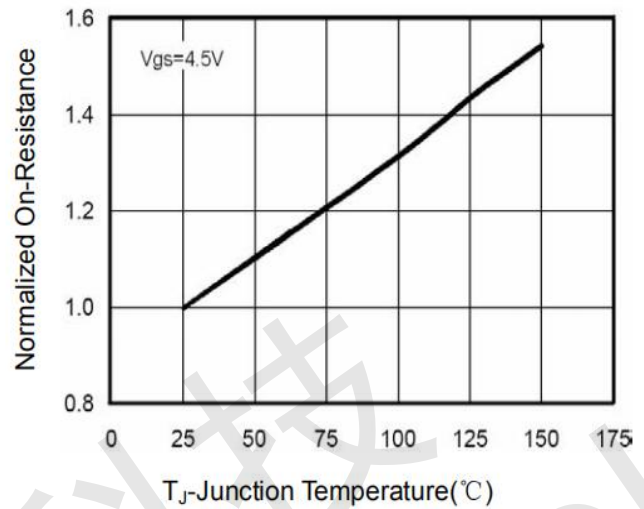
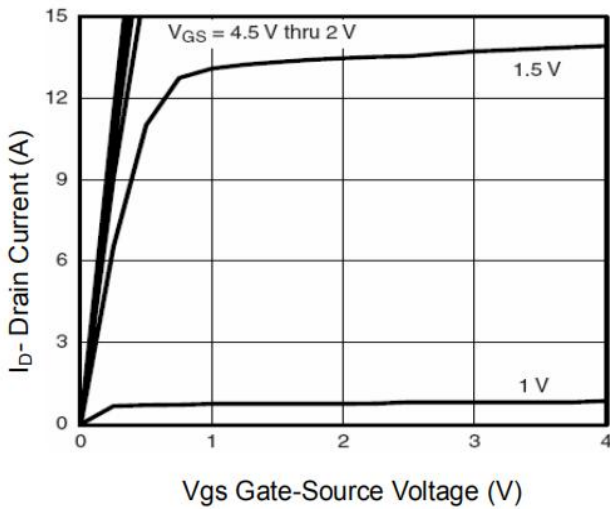

Figure 6 Drain-Source On-Resistance



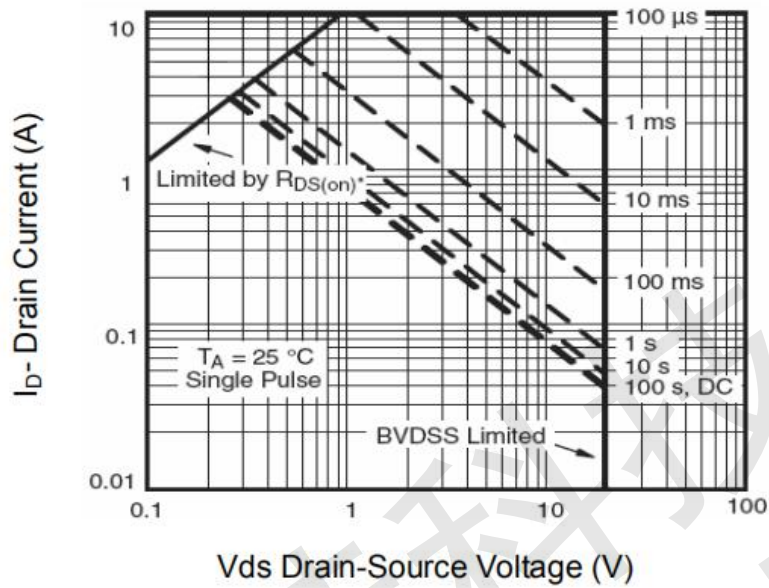

Figure 13 Safe Operation Area

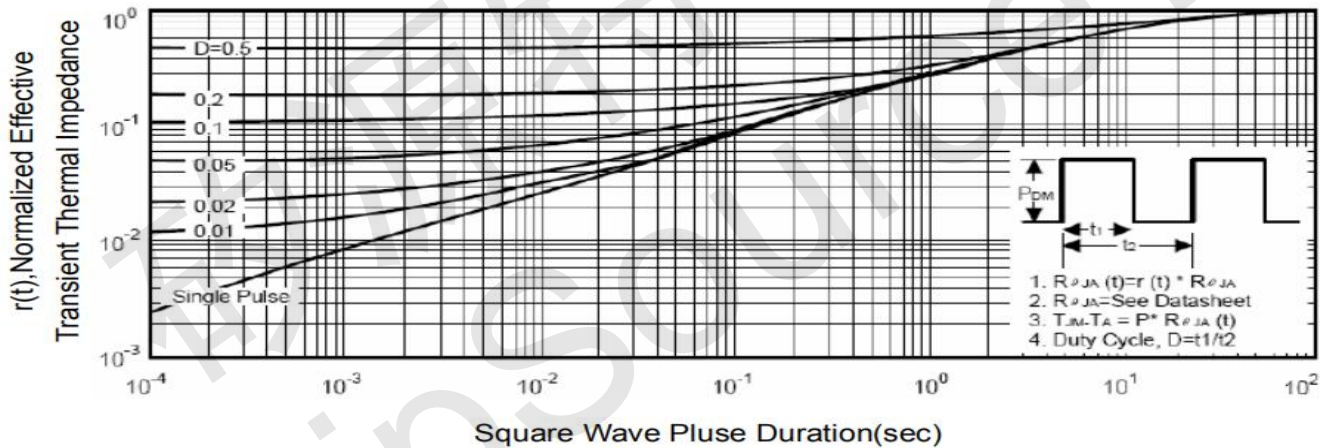
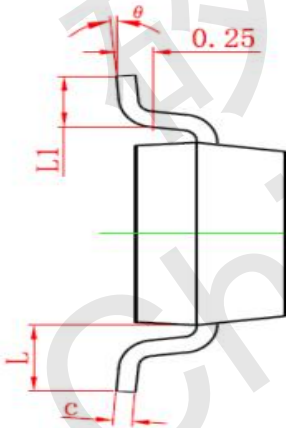
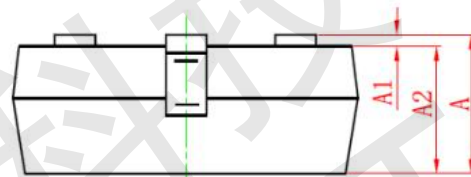
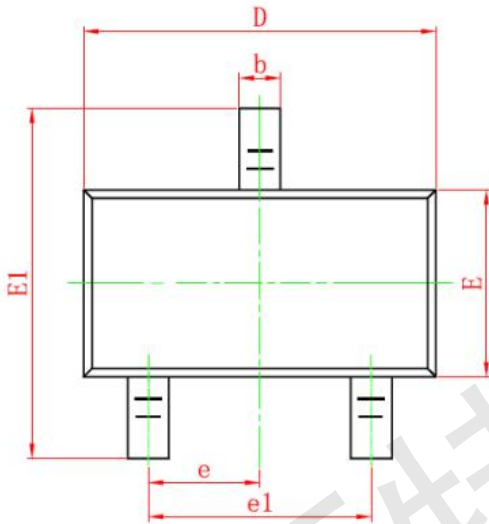

Figure 14 Normalized Maximum Transient Thermal Impedance



SOT-23 PACKAGE INFORMATION

Dimensions in Millimeters (UNIT:mm)



Symbol	Dimensions in Millimeters	
	MIN.	MAX.
A	0.900	1.150
A1	0.000	0.100
A2	0.900	1.050
b	0.300	0.500
c	0.080	0.150
D	2.800	3.000
E	1.200	1.400
E1	2.250	2.550
e	0.950TYP	
e1	1.800	2.000
L	0.550REF	
L1	0.300	0.500
θ	0°	8°

NOTES

1. All dimensions are in millimeters.
2. Tolerance $\pm 0.10\text{mm}$ (4 mil) unless otherwise specified
3. Package body sizes exclude mold flash and gate burrs. Mold flash at the non-lead sides should be less than 5 mils.
4. Dimension L is measured in gauge plane.
5. Controlling dimension is millimeter, converted inch dimensions are not necessarily exact.