



# JL8205A

## N-Channel Enhancement Mode Power MOSFET

### Description

The JL8205A uses advanced trench technology to provide excellent  $R_{DS(ON)}$ , low gate charge and operation with gate voltages as low as 2.5V. This device is suitable for use as a Battery protection or in other Switching application.

### General Features

- $V_{DS} = 20V$ ,  $I_D = 6A$   
 $R_{DS(ON)} < 34m\Omega$  @  $V_{GS}=2.5V$   
 $R_{DS(ON)} < 24m\Omega$  @  $V_{GS}=4.5V$
- High Power and current handling capability
- Lead free product is acquired
- Surface Mount Package

### Application

- Battery protection
- Load switch
- Power management

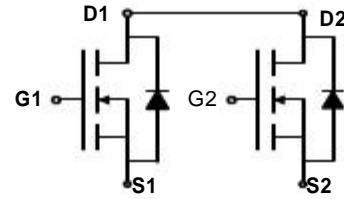

Schematic diagram

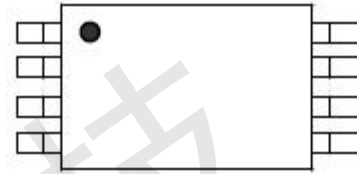

Marking and pin Assignment



TSSOP-8 top view

### Package Marking And Ordering Information

Device Marking	Device	Device Package	Reel Size	Tape width	Quantity
8205A	JL8205A	TSSOP-8	Ø330mm	12mm	3000 units

### Absolute Maximum Ratings (TA=25°C unless otherwise noted)

Parameter	Symbol	Limit	Unit
Drain-Source Voltage	$V_{DS}$	20	V
Gate-Source Voltage	$V_{GS}$	±10	V
Drain Current-Continuous	$I_D$	6	A
Drain Current-Pulsed (Note 1)	$I_{DM}$	25	A
Maximum Power Dissipation	$P_D$	1.5	W
Operating Junction and Storage Temperature Range	$T_J, T_{STG}$	-55 To 150	°C

### Thermal Characteristic

°C/W

Thermal Resistance, Junction-to-Ambient (Note 2)	$R_{\theta JA}$	83	
--	-----------------	----	--

### Electrical Characteristics (TA=25°C unless otherwise noted)

Parameter	Symbol	Condition	Min	Typ	Max	Unit
<b>Off Characteristics</b>						
Drain-Source Breakdown Voltage	$BV_{DSS}$	$V_{GS}=0V, I_D=250\mu A$	20	21	-	V
Zero Gate Voltage Drain Current	$I_{DSS}$	$V_{DS}=19.5V, V_{GS}=0V$	-	-	1	μA



**JL8205A**

Gate-Body Leakage Current	$I_{GSS}$	$V_{GS}=\pm 10V, V_{DS}=0V$	-	-	$\pm 100$	nA
<b>On Characteristics (Note 3)</b>						
Gate Threshold Voltage	$V_{GS(th)}$	$V_{DS}=V_{GS}, I_D=250\mu A$	0.5	0.7	1.2	V
Drain-Source On-State Resistance	$R_{DS(ON)}$	$V_{GS}=4.5V, I_D=4.5A$	-	20	24	m $\Omega$
		$V_{GS}=2.5V, I_D=3.5A$	-	25	34	m $\Omega$
Forward Transconductance	$g_{FS}$	$V_{DS}=5V, I_D=4.5A$	-	10	-	S
<b>Dynamic Characteristics (Note4)</b>						
Input Capacitance	$C_{iss}$	$V_{DS}=8V, V_{GS}=0V,$ $F=1.0MHz$	-	600	-	PF
Output Capacitance	$C_{oss}$		-	330	-	PF
Reverse Transfer Capacitance	$C_{rss}$		-	140	-	PF
<b>Switching Characteristics (Note 4)</b>						
Turn-on Delay Time	$t_{d(on)}$	$V_{DD}=10V, I_D=1A$ $V_{GS}=4.5V, R_{GEN}=6\Omega$	-	10	20	nS
Turn-on Rise Time	$t_r$		-	11	25	nS
Turn-Off Delay Time	$t_{d(off)}$		-	35	70	nS
Turn-Off Fall Time	$t_f$		-	30	60	nS
Total Gate Charge	$Q_g$	$V_{DS}=10V, I_D=6A,$ $V_{GS}=4.5V$	-	10	15	nC
Gate-Source Charge	$Q_{gs}$		-	2.3	-	nC
Gate-Drain Charge	$Q_{gd}$		-	1.5	-	nC
<b>Drain-Source</b>						
Diode Forward Voltage (Note 3)	$V_{SD}$	$V_{GS}=0V, I_S=1.7A$	-	0.75	1.2	V
Diode Forward Current (Note 2)	$I_S$		-	-	1.7	A



# JL8205A

## TYPICAL ELECTRICAL AND THERMAL CHARACTERISTICS

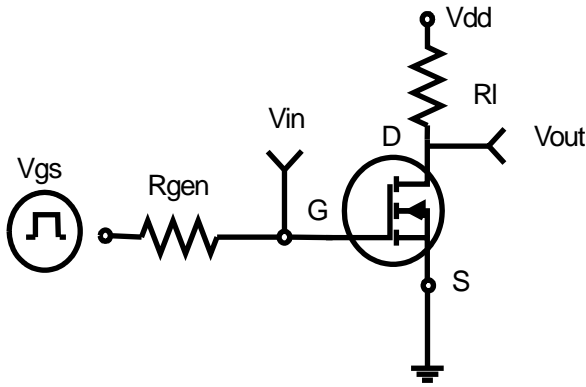

Figure 1: Switching Test Circuit

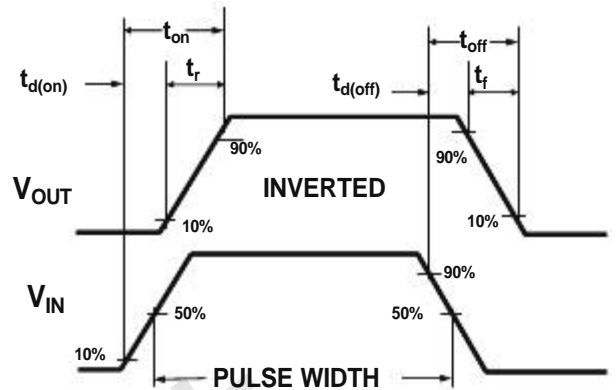

Figure 2: Switching Waveforms

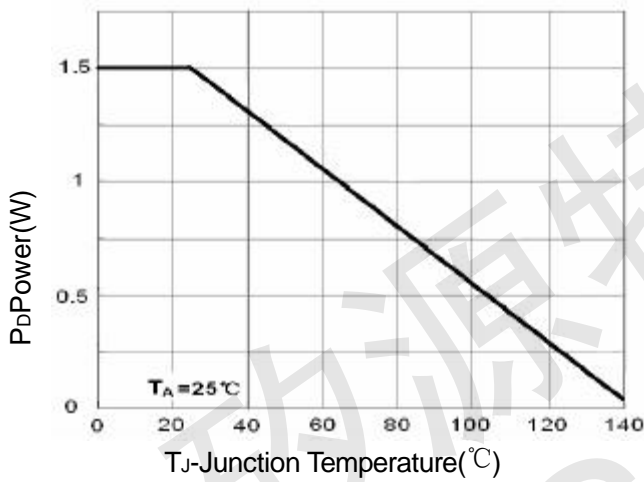

Figure 3 Power Dissipation

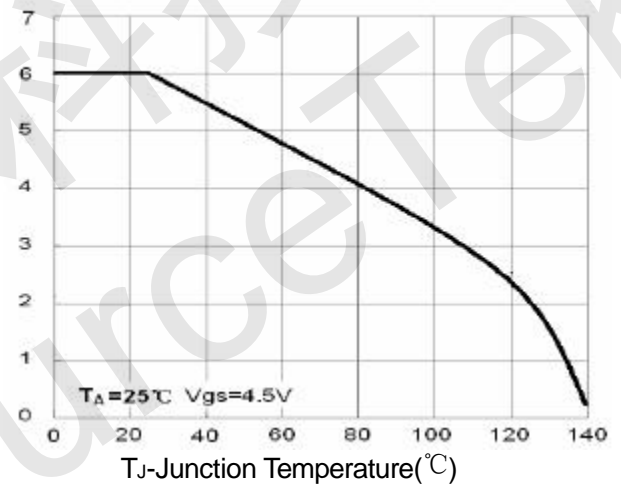

Figure 4 Drain Current

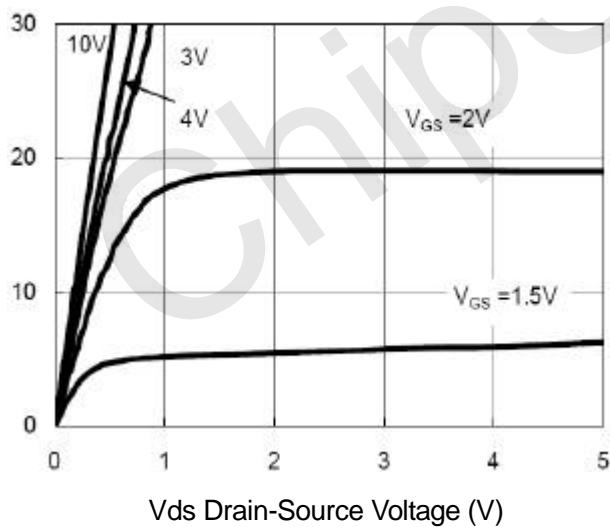

Figure 5 Output CHARACTERISTICS

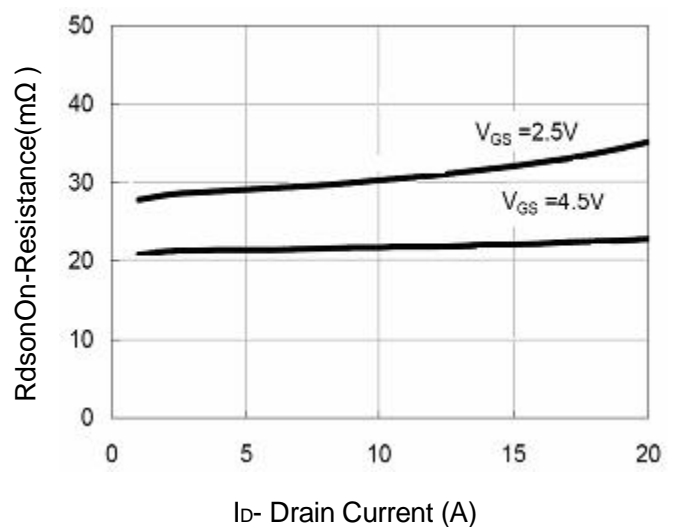
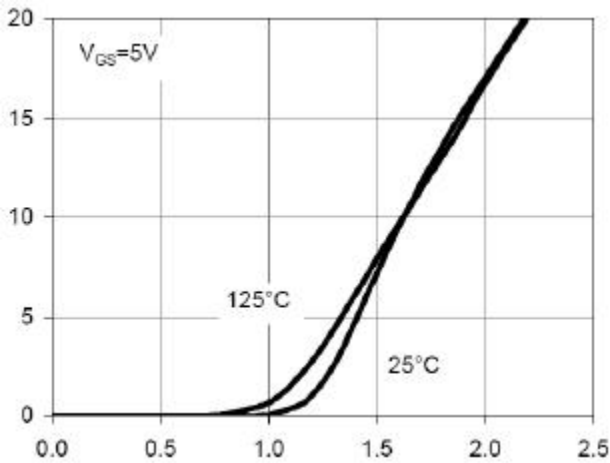

Figure 6 Drain-Source On-Resistance



# JL8205A



Vgs Gate-Source Voltage (V)  
**Figure 7 Transfer Characteristics**

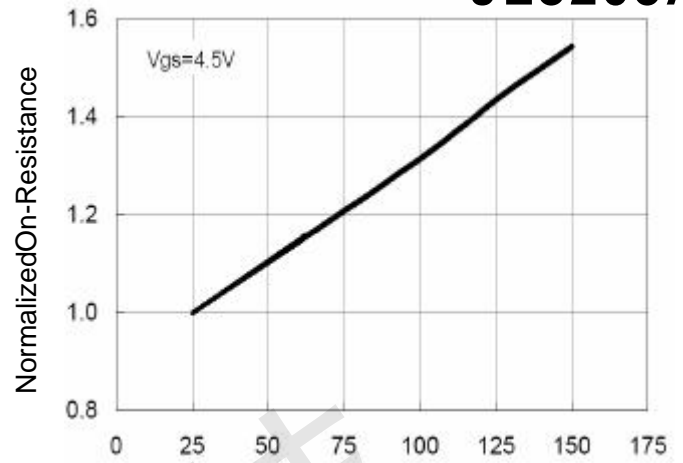

Tj-Junction Temperature (°C)  
**Figure 8 Drain-Source On-Resistance**

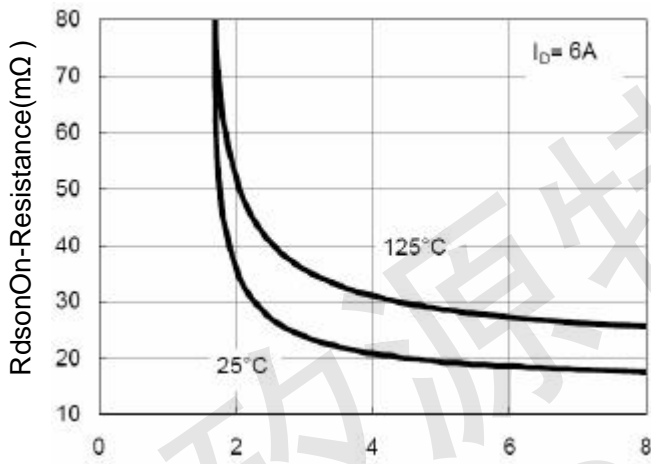

Vgs Gate-Source Voltage (V)  
**Figure 9 Rdson vs Vgs**

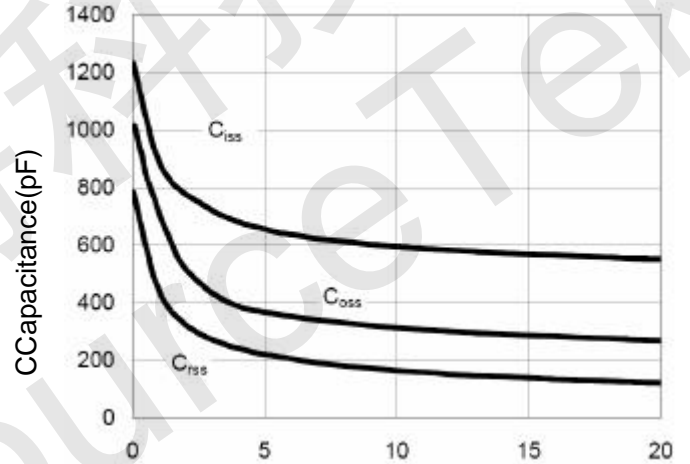

Vds Drain-Source Voltage (V)  
**Figure 10 Capacitance vs Vds**

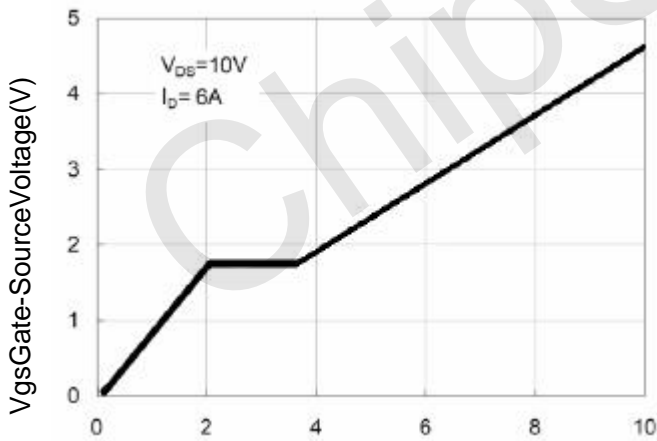

Qg Gate Charge (nC)  
**Figure 11 Gate Charge**

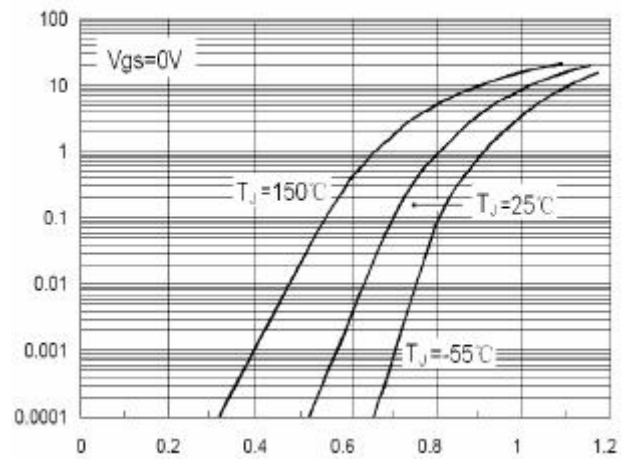

Vsd Source-Drain Voltage (V)  
**Figure 12 Source-Drain Diode Forward**

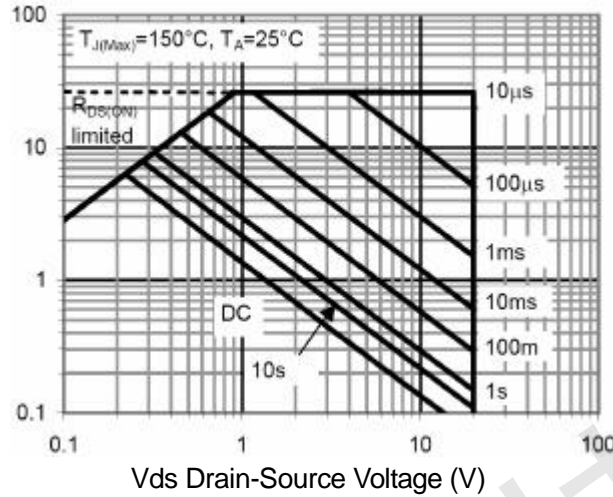

Figure 13 Safe Operation Area

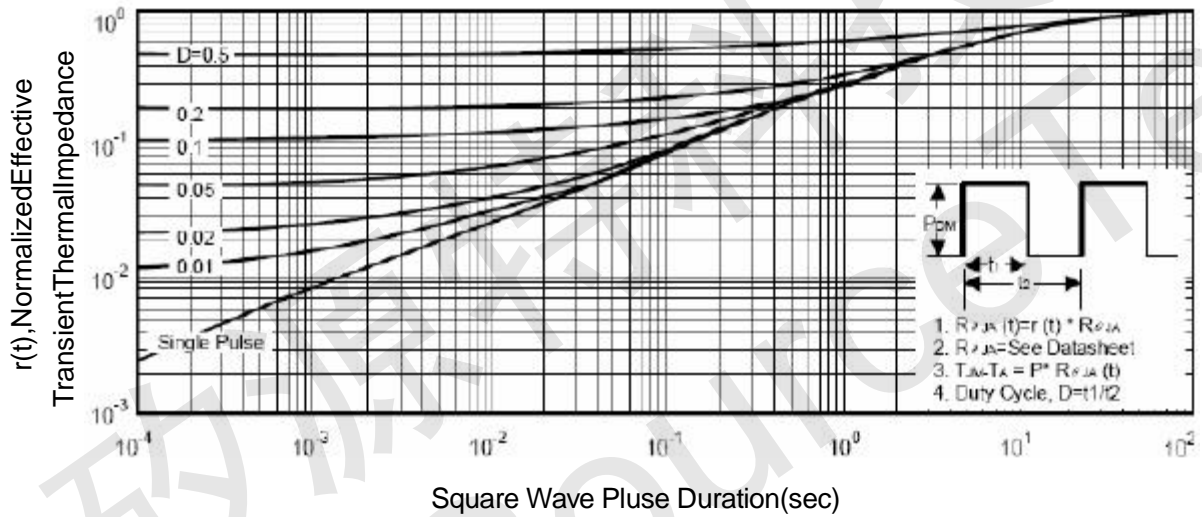
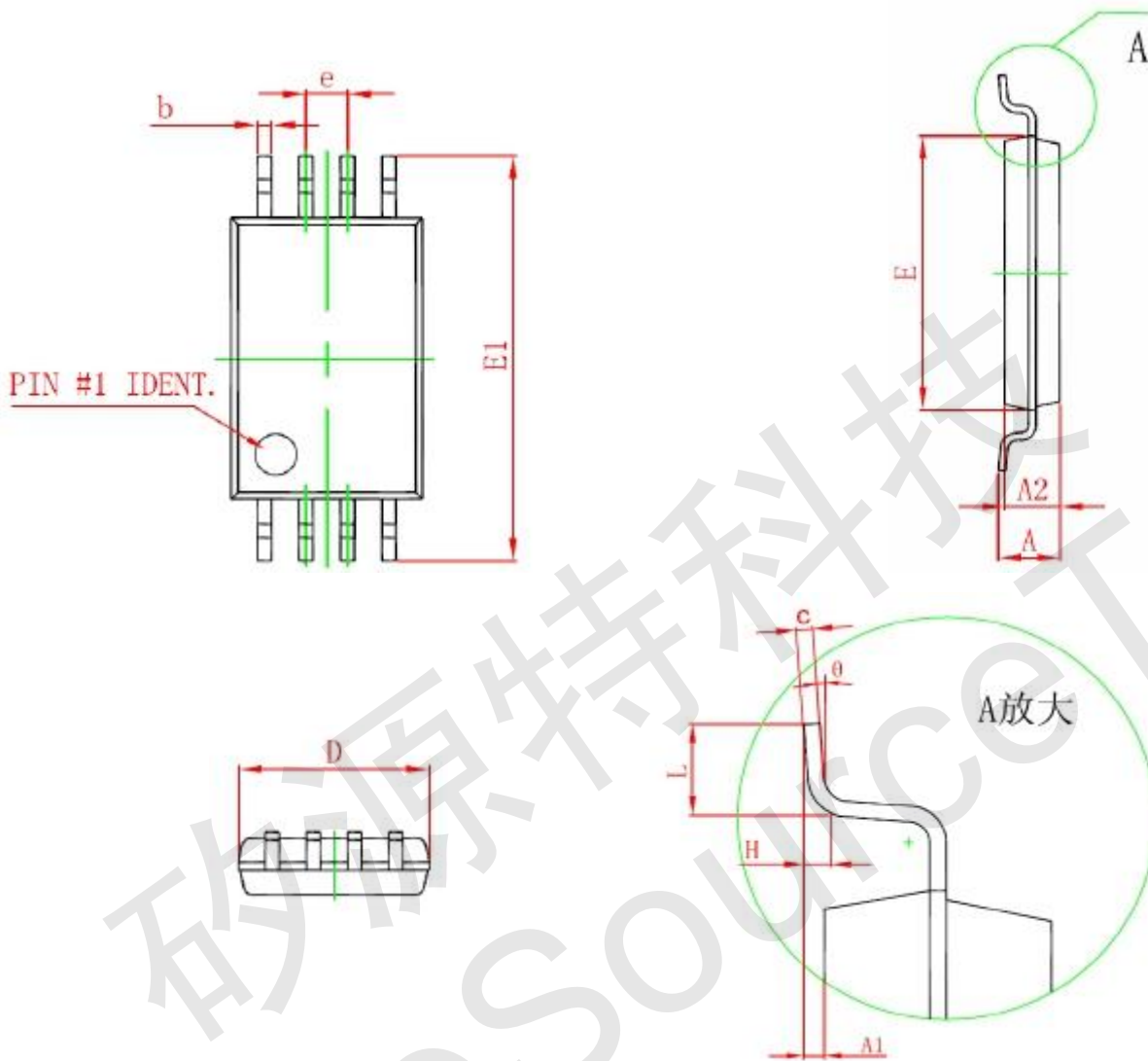

Figure 14 Normalized Maximum Transient Thermal Impedance





TSSOP-8 PACKAGE INFORMATION



Symbol	Dimensions In Millimeters	
	Min	Max
D	2.900	3.100
E	4.300	4.500
b	0.190	0.300
c	0.090	0.200
E1	6.250	6.550
A		1.100
A2	0.800	1.000
A1	0.020	0.150
e	0.65(BSC)	
L	0.500	0.700
H	0.25(TYP)	
$\theta$	1°	7°