



CST4056 1A Li-ion Battery Linear Charger

CST4056 Description

The CST4056 is a standalone linear Li-ion battery charger with ESOP8/DFN2X2-8L package. With few external components, CST4056 is well suited for a wide range of portable applications. Charging current can be programmed by an external resistor. In standby mode, supply current will be reduced to around 35uA. When the input voltage is disconnected, CST4056 enters the sleep state, and the battery leakage current will drop below 1uA.

Other features include UVLO, automatic recharge, charge status indicators and thermal regulation.

CST4056 Feature

- ◆ Up to 1000mA Programmable Charge Current
- ◆ No External MOSFET, Sense Resistor, or Blocking Diode Required
- ◆ Standalone Linear Charger for Single Cell Li-ion Batteries
- ◆ Preset Charge Voltage with: $4.2V-1\% \sim 4.2V+2\%$
- ◆ Automatic Recharge
- ◆ Charge Status Indicators for No Battery and Charge Failure Display
- ◆ C/10 Charge Termination
- ◆ 35uA Standby Supply Current
- ◆ 2.9V Trickle Charge Voltage
- ◆ Thermal Protection
- ◆ Soft-Start to Limit Inrush Current
- ◆ reverse protection

CST4056 Application

- ◆ Mobile Phone、PDA
- ◆ MP3、MP4
- ◆ Charger
- ◆ DSC
- ◆ Palmtop
- ◆ Bluetooth , GPS
- ◆ Portable Device

PackageType : ESOP8 / DFN2*2-8L

CST4056 Pin Description

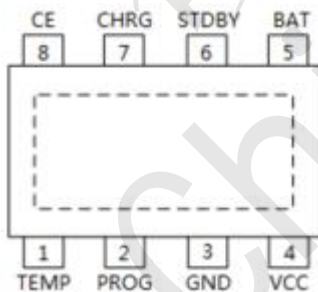

ESOP8

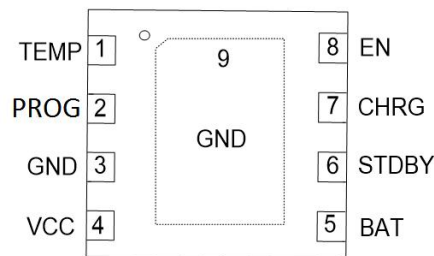

DFN2*2-8L



CST4056 1A Li-ion Battery Linear Charger

CST4056 Typical Application Circuit

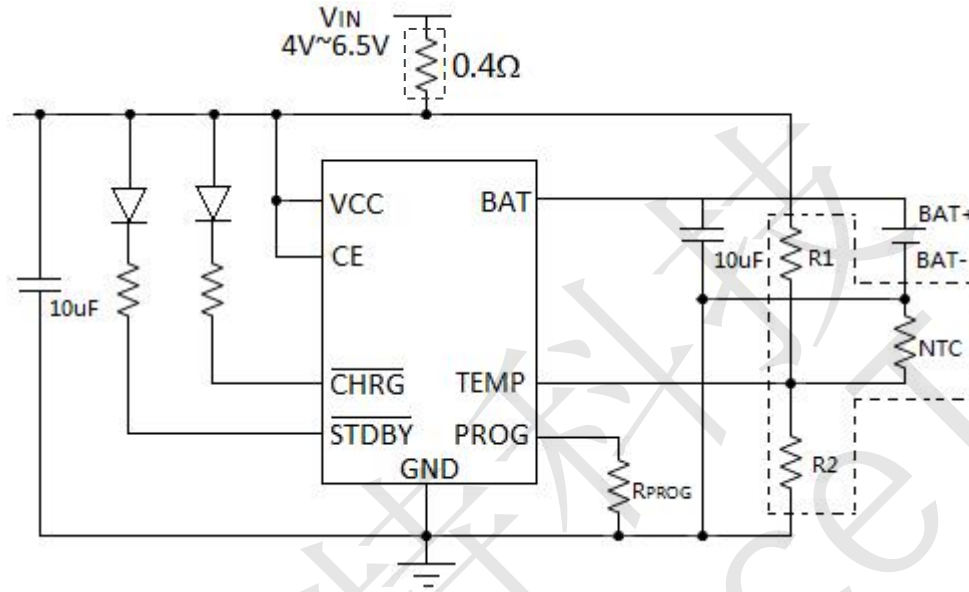

R1/R2/NTC resistors are optional. The TEMP pin can also be directly grounded without monitoring the battery temperature



CST4056 1A Li-ion Battery Linear Charger

CST4056 Pin Assignment

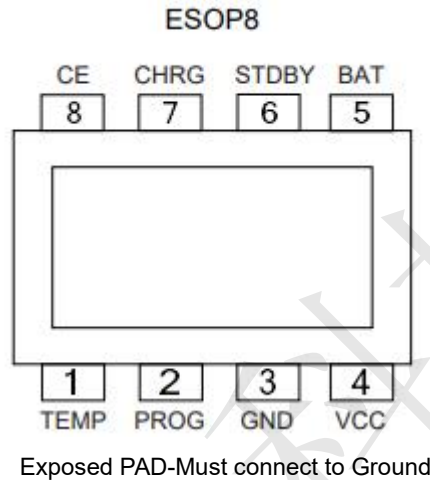

Pin Number	Pin Name	Description
1	TEMP	Battery Temperature Detector
2	PROG	CC Charge Current Setting & Monitor
3	GND	IC Ground
4	VCC	Supply Voltage
5	BAT	Battery Voltage
6	STDBY	Charge State Indicator
7	CHRГ	Charge State Indicator
8	CE	Enable



CST4056 1A Li-ion Battery Linear Charger

CST4056 Absolute Maximum Ratings

Parameter	Range	Unit
Supply Voltage	-0.3 to 6.5	V
PROG, BAT, CE, TEMP voltage	-0.3 to 6.5	V
CHRG pin voltage	-0.3 to 8	V
STDBY pin voltage	-0.3 to 8	V
BAT Pin Current	1	A
PROG Pin Current	2	mA
Allowable Power Dissipation	1500	mW
Operating Temperature	-40 ~ 85	°C
Storage Temperature	-65 to 125	°C

CST4056 ESD/Latch-up

Parameter	Range
HBM	4000V
MM	400 V
Latch-up	400mA



CST4056 1A Li-ion Battery Linear Charger

CST4056 BLOCK DIAGRAM

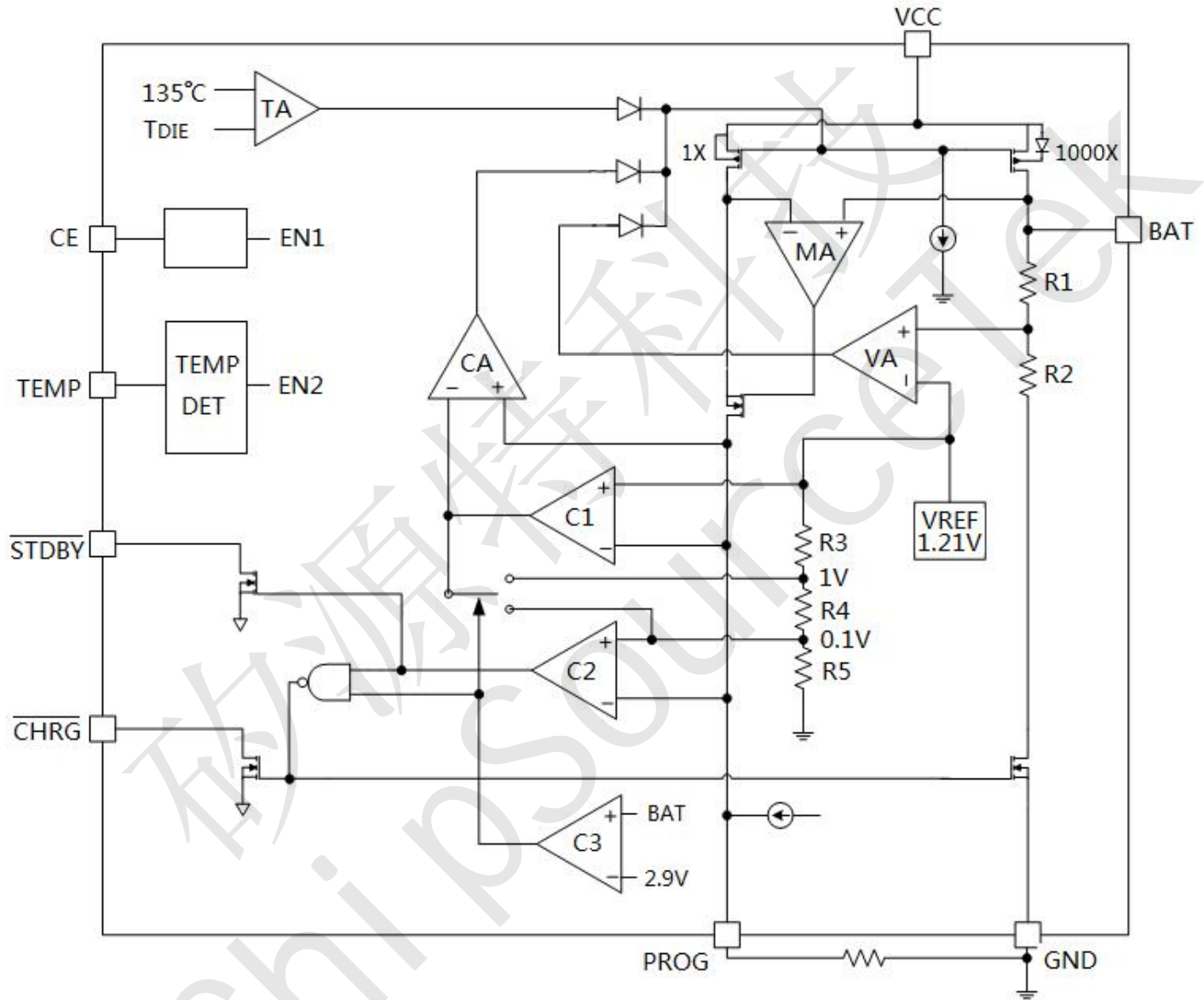



CST4056 1A Li-ion Battery Linear Charger

CST4056 DC Electrical Characteristics ($V_{CC}=5V$, $T_A=25^\circ C$, unless otherwise noted)

Symbol	Parameter	Test Conditions	Min.	Typ.	Max.	Unit
V_{CC}	Supply Voltage		4.2		6.5	V
I_{CC}	Supply Current	Charge mode($R_{PROG}=12K$) (1)		240	500	μA
		Stand-by mode (Charge Termination)		50	100	μA
		Shunt-down mode($V_{CC}<V_{BAT}$, $V_{CC}<V_{UVLO}$ R_{PROG} not connect)		35	70	μA
V_{FLOAT}	CV Output (Float) Voltage	$0^\circ C \leq T \leq 85^\circ C$	4.158	4.2	4.284	V
I_{BAT}	BAT Pin Current	CC MODE, $R_{PROG}=2.4K$	465	500	535	mA
		CC MODE, $R_{PROG}=1.2K$	930	1000	1070	mA
		Stand-by mode, $V_{BAT}=4.2V$	0	-2.5	-6	μA
		Shunt-down mode		1	2	μA
		BAT Reverse, $V_{BAT}=-4V$		0.7		mA
		Sleep mode, $V_{CC}=0V$		0	1	μA
I_{TRIKL}	Trickle Charge Current	$V_{BAT}<V_{TRIKL}$, $R_{PROG}=2.4K$	40	50	60	mA
		$V_{BAT}<V_{TRIKL}$, $R_{PROG}=1.2K$	80	100	120	mA
V_{TRIKL}	Trickle Charge Threshold Voltage	V_{BAT} Rising	2.8	2.9	3.0	V
V_{TRHYS}	Trickle Charge Hysteresis Voltage	V_{BAT} Falling	60	80	100	mV
V_{UVLO}	V_{CC} Under Voltage Lockout Threshold	V_{CC} Rising	3.7	3.8	3.93	V
V_{UVHYS}	V_{CC} Under Voltage Lockout Threshold Hysteresis	V_{CC} Falling	150	200	300	mV
V_{MSD}	Manual shutdown threshold voltage	PROG Rising	1.15	1.21	1.30	V
		PROG Falling	0.9	1.0	1.1	V
V_{ASD}	$V_{CC}-V_{BAT}$ Lockout Threshold	V_{CC} Rising	70	100	140	mV
		V_{CC} Falling	5	30	50	mV
I_{TERM}	C/10 Termination Comparator Filter Time (2)	$R_{PROG}=1.2K$	0.085	0.10	0.115	mA/mA
		$R_{PROG}=2.4K$	0.085	0.10	0.115	mA/mA
V_{PROG}	PROG Pin Voltage	CC MODE, $R_{PROG}=1.2K$	0.93	1.0	1.07	V
V_{CHRG}	CHRG Pin Output Low Voltage	$I_{CHRG}=5mA$		0.35	0.6	V
V_{STDBY}	STDBY Pin Output Low	$I_{STDBY}=5mA$		0.35	0.6	V
V_{TEMP_H}	TEMP pin high threshold voltage			80	83	%VCC
V_{TEMP_L}	TEMP pin low threshold voltage		42	45		%VCC
ΔV_{RECHG}	Battery Recharge Threshold Voltage	$V_{FLOAT}-V_{RECHG}$		100	200	mV



CST4056 1A Li-ion Battery Linear Charger

TRECHG	Recharge Comparator Filter Time	VBAT High to Low	0.8	1.8	4	ms
TERM	C/10 Termination Comparator Filter Time	IBAT Falling below ITERM	0.63	1.4	3	ms
I _{PROG}	PROG Pin Pull-up Current			2.0		uA
VCE_H	CE High		1.3			V
VCE_L	CE low				0.7	V

Notes (1) : At this time it is charging, $ICC=IVCC-IBAT$

(2) : C/10 termination current threshold refers to the ratio of termination current to constant current charging current



CST4056 1A Li-ion Battery Linear Charger

CST4056 Function Description

CST4056 is a linear charger specially designed for lithium-ion batteries, which uses the power MOSFET inside the chip to charge the battery with constant current/constant voltage. The charging current can be programmed by an external resistor, and the maximum charging current can reach 1000mA. CST4056 has two open-drain output status indication output terminals, charging status indication terminal CHRГ and battery charging completion indication output terminal STDBY. The power tube circuit inside the chip automatically reduces the charging current when the junction temperature of the chip exceeds 135°C. This function allows users to maximize the use of chip charging without worrying about chip overheating and damage to the chip or external components.

When the input voltage is greater than the UVLO detection threshold and the chip enable input terminal CE is connected to high level, CST4056 starts to charge the battery. If the battery voltage is lower than 2.9V, the charger precharges the battery with a small current. When the battery voltage exceeds 2.9V, the charger adopts constant current mode to charge the battery, and the charging current is determined by the resistance between the PROG terminal and the GND terminal. When the battery voltage is close to 4.2V, the charging current gradually decreases, and CST4056 enters the constant voltage charging mode. The charging cycle ends when the charging current decreases to the end-of-charge threshold.

The end-of-charge threshold is 1/10 of the constant-current charge current. When the battery voltage drops below the recharge threshold, a new charge cycle is automatically started. The high-precision voltage reference source, error amplifier and resistor divider network inside the chip ensure that the accuracy of the modulation voltage at the BAT terminal is within 1%, which meets the requirements of lithium-ion and lithium-polymer batteries. When the input voltage drops or the input voltage is lower than the battery voltage, the charger enters shutdown mode, and the current consumed by the battery terminal is less than 2uA, thereby increasing the standby time.

If the enable input terminal CE is connected to a low level, the charger stops charging.

●charging current

The relationship between RPROG and charging current can be determined by referring to the following table: :

$$R_{PROG} = \frac{1200}{I_{BAT}}$$

RPROG(K)	IBAT(mA)
1.2	1000
2.4	500
3.0	400
4.0	300
6.0	200
12.0	100



CST4056 1A Li-ion Battery Linear Charger

●charge termination

When the charge current drops to 1/10 of the set value after reaching the final float voltage, the charge cycle is terminated. This condition is detected by monitoring the PROG terminal with an internal filtered comparator. When the PROG terminal voltage drops below 100mV for more than 1.8ms, charging is terminated and CST4056 enters standby mode, at which time the input power current drops to about 50uA.

When charging, the transient load on the BAT terminal will cause the PROG terminal voltage to drop below 100mV briefly between the DC charging current drops to 1/10 of the set value, and the 1.8ms delay time of the comparator ensures this property transient loads will not cause premature termination of the charge cycle. Once the average charge current drops below 1/10 of the set value, the CST4056 centralizes the charge cycle and stops supplying any current through the BAT terminal. In this state, all loads on the BAT terminal must be powered by the battery.

●charging status indicator

CST4056 has two open-drain status indication outputs CHRG and STDBY. When the charger is in the charging state, CHRG is pulled to a low level, and in other states CHRG is in a high-impedance state; when the battery is charged, STDBY is pulled to a low level, and in other states STDBY is in a high-impedance state.

When the battery is not connected to the charger, CHRG flashes to indicate that there is no battery installed.

STATUS	CHRG	STDBY
Charging	on	Off
finished charging	off	on
Undervoltage, battery temperature is too high, too low Waiting for fault status, or no battery access (TEMP use)	off	off
Connect 1uF capacitor to BAT terminal, no battery	flashing (Freq 20Hz)	on

●Thermal

An internal thermal feedback loop reduces the programmed charge current if the die temperature rises above 135°C. This feature prevents the CST4056 from overheating and allows the user to increase the upper limit of a given board's power handling capability while reducing the risk of damaging the CST4056.

●Battery temperature detection

In order to prevent damage to the battery caused by high or low temperature, CST4056 integrates a battery temperature monitoring circuit inside. Battery temperature monitoring is realized by measuring the voltage of the TEMP pin, which is realized by an NTC thermistor inside the battery and a resistor divider network, as shown in the typical application diagram. If the voltage of the TEMP pin is less than 45% of the input voltage or greater than 80% of the input voltage, it means that the battery temperature is too low or too high, and the charging is suspended.

If the TEMP pin is directly connected to GND, the battery temperature detection function is canceled, and other charging functions are normal.



CST4056 1A Li-ion Battery Linear Charger

The values of R1 and R2 should be determined according to the temperature monitoring range of the battery and the resistance value of the thermistor. The examples are as follows:

Assume that the set battery temperature range is $T_L \sim T_H$, (where $T_L < T_H$); the battery uses a negative temperature coefficient thermistor (NTC), R_{TL} is its resistance at the temperature T_L , and R_{TH} is its resistance at the temperature T_H . The resistance value at the temperature T_H , then $R_{TL} > R_{TH}$, then, at the temperature T_L , the voltage at the first pin TEMP is:

$$V_{TEMP_L} = \frac{R_2 \parallel R_{TL}}{R_1 + R_2 \parallel R_{TL}} \times V_{IN}$$

At the temperature T_H , the voltage at the first pin TEMP is:

$$V_{TEMP_H} = \frac{R_2 \parallel R_{TH}}{R_1 + R_2 \parallel R_{TH}} \times V_{IN}$$

$$V_{TEMP_L} = V_{HIGH} = K_2 \times V_{CC} (K_2 = 0.8)$$

$$V_{TEMP_H} = V_{LOW} = K_1 \times V_{CC} (K_1 = 0.45)$$

$$R_1 = \frac{R_{TL} R_{TH} (K_2 - K_1)}{(R_{TL} - R_{TH}) K_1 K_2}$$

$$R_2 = \frac{R_{TL} R_{TH} (K_2 - K_1)}{R_{TL} (K_1 - K_1 K_2) - R_{TH} (K_2 - K_1 K_2)}$$

Similarly, if the inside of the battery is a thermistor with a positive temperature coefficient (PTC), then $>$, we can calculate:

$$R_1 = \frac{R_{TL} R_{TH} (K_2 - K_1)}{(R_{TH} - R_{TL}) K_1 K_2}$$

$$R_2 = \frac{R_{TL} R_{TH} (K_2 - K_1)}{R_{TH} (K_1 - K_1 K_2) - R_{TL} (K_2 - K_1 K_2)}$$

It can be seen from the above derivation that the temperature range to be set has nothing to do with the power supply voltage V_{CC} , and is only related to R_1 , R_2 , R_{TH} , and R_{TL} ; among them, R_{TH} and R_{TL} can be checked by referring to the relevant battery manual or through experiments get.

In practical applications, if you only care about the temperature characteristics of a certain end, such as overheating protection, then R_2 can be used instead of R_1 . The derivation of R_1 also becomes simple, and will not be repeated here.



CST4056 1A Li-ion Battery Linear Charger

●UVLO

CST4056 has an internal under-voltage lockout circuit to monitor the input voltage and keep the chip in shutdown mode before VCC rises to the under-voltage lockout threshold voltage. When the VCC voltage rises to 3.8V, the chip exits UVLO and starts to work normally. The UVLO hysteresis voltage is 200mV when VCC is falling.

●automatic charge cycle

When the battery voltage reaches the float voltage and the charge cycle is terminated, the CST4056 immediately monitors the BAT terminal voltage. When the BAT terminal voltage is lower than 4.1V, the charging cycle starts again. This ensures that the battery is maintained at a near-full state while eliminating the need for periodic charge cycle initiation.

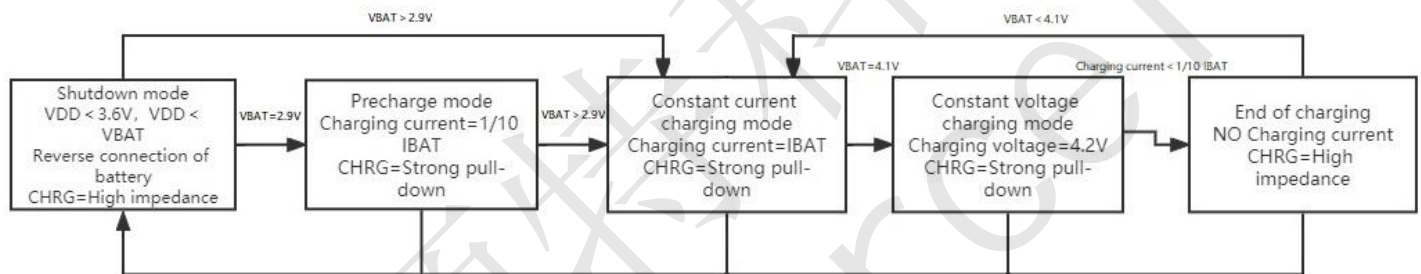

State diagram of a typical charging cycle

●Battery reverse polarity protection

CST4056 has lithium battery reverse connection protection function. When the positive and negative poles of the battery are reversely connected to the voltage output BAT pin of CST4056, CST4056 will stop and display a fault state without charging current. The charging indicator pin is in a high-impedance state, and the RLED is off. At this time, the leakage current of the reversely connected battery is less than 1mA. Connect the reversed battery correctly, and the CST4056 will automatically start the charging cycle.



CST4056 1A Li-ion Battery Linear Charger

CST4056 Package Outline: ESOP8

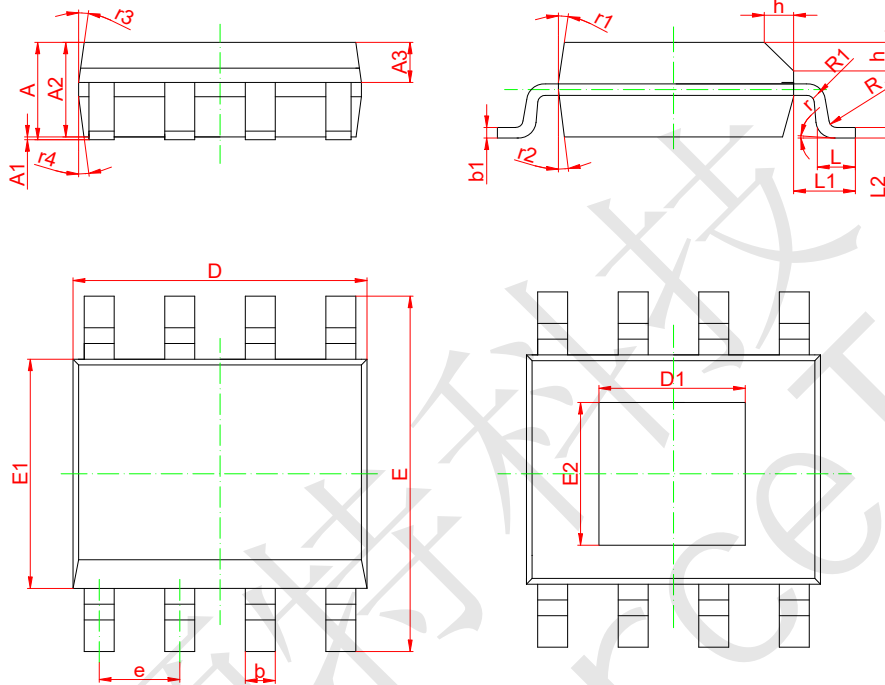

SYMBOL	MIN	NOM	MAX
A	1.35	1.55	1.70
A1	0	0.10	0.15
A2	1.25	1.40	1.65
A3	0.50	0.60	0.70
b	0.38	-	0.51
b1	0.37	0.42	0.47
D	4.80	4.90	5.00
D1	3.10	3.30	3.50
E	5.80	6.00	6.20
E1	3.80	3.90	4.00
E2	2.20	2.40	2.60
e	1.17	1.27	1.37
L	0.45	0.60	0.80
L1	1.04REF		
L2	0.25BSC		
R	0.07	-	-
R1	0.07	-	-
h	0.30	0.40	0.50
r	0°	-	8°
r1	15°	17°	19°
r2	11°	13°	15°
r3	15°	17°	19°
r4	11°	13°	15°



CST4056 1A Li-ion Battery Linear Charger

CST4056 Package Outline: DFN2*2-8

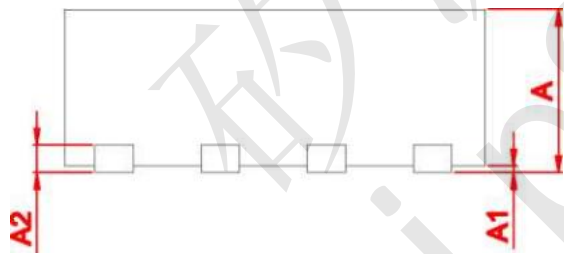
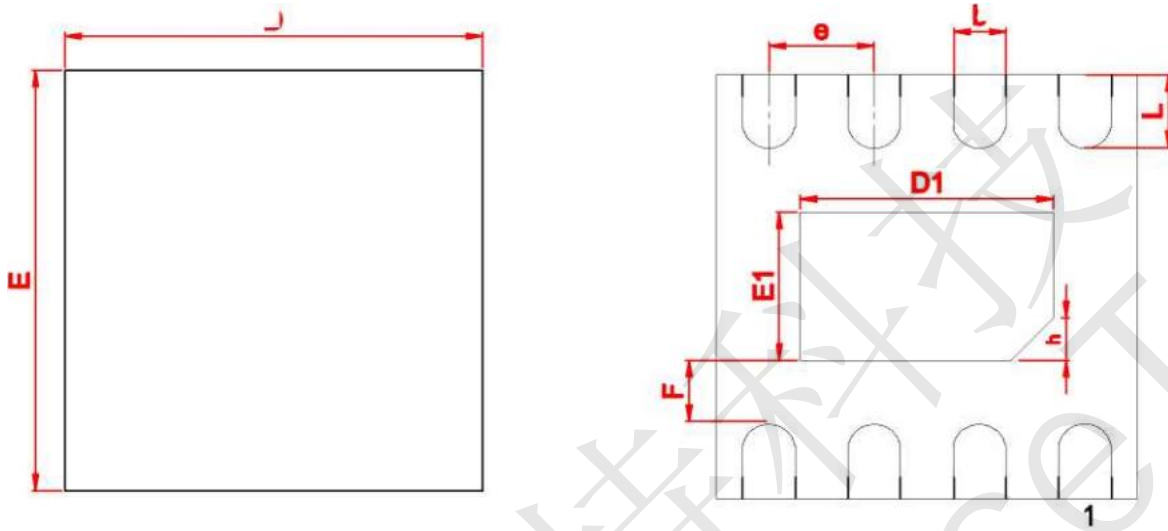

SYMBOL	MILLIMETER		
	MIN	NOM	MAX
A	0.700	0.750	0.800
*A1	0.000	0.020	0.050
* b	0.200	0.250	0.300
*A2	0.180	0.200	0.220
* D	1.900	2.000	2.100
* E	1.900	2.000	2.100
*D1	1.100	1.200	1.300
*E1	0.600	0.700	0.800
* e	0.450	0.500	0.550
* L	0.300	0.350	0.400
* F	0.250	0.300	0.350
h	R	IEF	0



CST4056 1A Li-ion Battery Linear Charger

- The information described herein is subject to change without notice.
- ChipSourceTek Technology is not responsible for any problems caused by circuits or diagrams described herein whose related industrial properties, patents, or other rights belong to third parties. The application circuit examples explain typical applications of the products, and do not guarantee the success of any specific mass-production design.
- When the products described herein are regulated products subject to the Wassenaar Arrangement or other agreements, they may not be exported without authorization from the appropriate governmental authority.
- Use of the information described herein for other purposes and/or reproduction or copying without the express permission of ChipSourceTek Technology is strictly prohibited.
- The products described herein cannot be used as part of any device or equipment affecting the human body, such as exercise equipment, medical equipment, security systems, gas equipment, or any apparatus installed in airplanes and other vehicles, without prior written permission of ChipSourceTek Technology.
- Although ChipSourceTek Technology exerts the greatest possible effort to ensure high quality and reliability, the failure or malfunction of semiconductor products may occur. The user of these products should therefore give thorough consideration to safety design, including redundancy, fire-prevention measures, and malfunction prevention, to prevent any accidents, fires, or community damage that may ensue.