



**N-Channel Enhancement Mode Power MOSFET**

**Description**

The PED30H15G uses advanced trench technology to provide excellent  $R_{DS(ON)}$  and low gate charge. It can be used in a wide variety of applications.

**General Features**

- $V_{DS} = 30V, I_D = 80A$

$R_{DS(ON)} < 3m\Omega @ V_{GS}=10V$

$R_{DS(ON)} < 4m\Omega @ V_{GS}=4.5V$

- High Power and current handling capability
- Lead free product is acquired
- Surface Mount Package

**Application**

- Battery management
- Motor controller and driver
- PWM applications
- Load switch

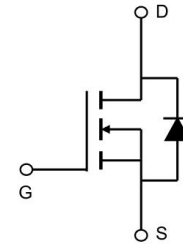

Schematic diagram

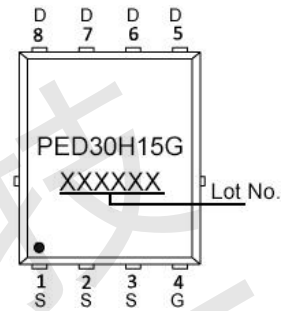

Marking and pin assignment

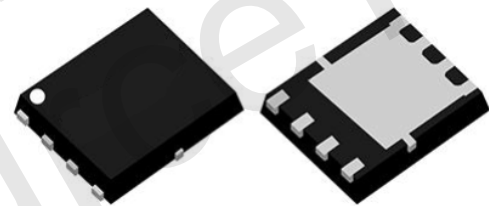

DFN5x6-8L

**Absolute Maximum Ratings (TC=25°C unless otherwise noted)**

Parameter	Symbol	Rating	Unit
Drain-Source Voltage	$V_{DS}$	30	V
Gate-Source Voltage	$V_{GS}$	$\pm 20$	V
Drain Current-Continuous	$I_D$	80	A
Drain Current-Continuous ( $T_C=100^\circ C$ )	$I_D(T_C=100^\circ C)$	55	A
Pulsed Drain Current (Note 1)	$I_{DM}$	220	A
Maximum Power Dissipation	$P_D$	42	W
Avalanche current	$I_{AS}$	68	A
Avalanche Energy (L=0.1mH)	$E_{AS}$	231	mJ
Operating Junction and Storage Temperature Range	$T_J, T_{STG}$	-55 To 150	$^\circ C$

**Thermal Characteristic**

Thermal Resistance, Junction-to-Case (Note 2)	$R_{\theta JC}$	3	$^\circ C/W$
---	-----------------	---	--------------



**Electrical Characteristics (TC=25°C unless otherwise noted)**

Parameter	Symbol	Condition	Min	Typ	Max	Unit
<b>Off Characteristics</b>						
Drain-Source Breakdown Voltage	$BV_{DSS}$	$V_{GS}=0V, I_D=250\mu A$	30	-	-	V
Zero Gate Voltage Drain Current	$I_{DSS}$	$V_{DS}=30V, V_{GS}=0V$	-	-	1	$\mu A$
Gate-Body Leakage Current	$I_{GSS}$	$V_{GS}=\pm 20V, V_{DS}=0V$	-	-	$\pm 100$	nA
<b>On Characteristics (Note 3)</b>						
Gate Threshold Voltage	$V_{GS(th)}$	$V_{DS}=V_{GS}, I_D=250\mu A$	1.2	1.6	2.2	V
Drain-Source On-State Resistance	$R_{DS(on)}$	$V_{GS}=10V, I_D=20A$	-	2.3	3	m $\Omega$
		$V_{GS}=4.5V, I_D=20A$	-	2.8	4	m $\Omega$
Forward Transconductance	$g_{FS}$	$V_{DS}=5V, I_D=20A$	-	110	-	S
<b>Dynamic Characteristics (Note 4)</b>						
Input Capacitance	$C_{iss}$	$V_{DS}=15V, V_{GS}=0V,$ $F=1.0MHz$	-	5280	-	pF
Output Capacitance	$C_{oss}$		-	520	-	pF
Reverse Transfer Capacitance (Note 4)	$C_{riss}$		-	440	-	pF
Gate Resistance	$R_g$	$V_{DS}=0V, V_{GS}=0V, F=1.0MHz$	-	3	-	$\Omega$
<b>Switching Characteristics</b>						
Turn-on Delay Time	$t_{d(on)}$	$V_{DS}=15V, R_L=1\Omega,$ $V_{GS}=10V, R_G=3\Omega$	-	19	-	nS
Turn-on Rise Time	$t_r$		-	20	-	nS
Turn-Off Delay Time	$t_{d(off)}$		-	54	-	nS
Turn-Off Fall Time	$t_f$		-	18	-	nS
Total Gate Charge	$Q_g$	$V_{DS}=15V, I_D=20A, V_{GS}=10V$	-	90	-	nC
Gate-Source Charge	$Q_{gs}$		-	13	-	nC
Gate-Drain Charge	$Q_{gd}$		-	16	-	nC
<b>Drain-Source Diode Characteristics</b>						
Diode Forward Voltage (Note 3)	$V_{SD}$	$V_{GS}=0V, I_S=1A$	-	-	1.2	V
Diode Forward Current (Note 2)	$I_S$		-	-	50	A

**Notes:**

1. Repetitive Rating: Pulse width limited by maximum junction temperature.
2. Surface Mounted on FR4 Board,  $t \leq 10$  sec.
3. Pulse Test: Pulse Width  $\leq 300\mu s$ , Duty Cycle  $\leq 2\%$ .
4. Guaranteed by design, not subject to product.



**Typical Electrical and Thermal Characteristics**

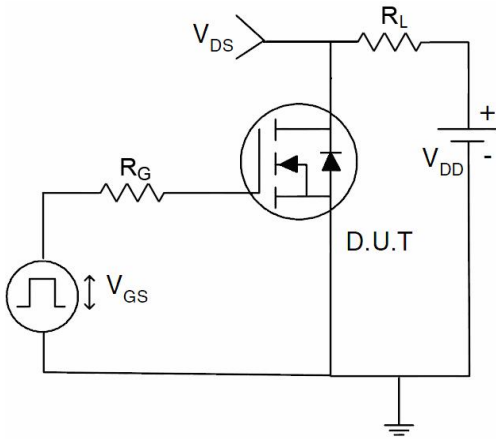

**Figure 1 Switching Test Circuit**

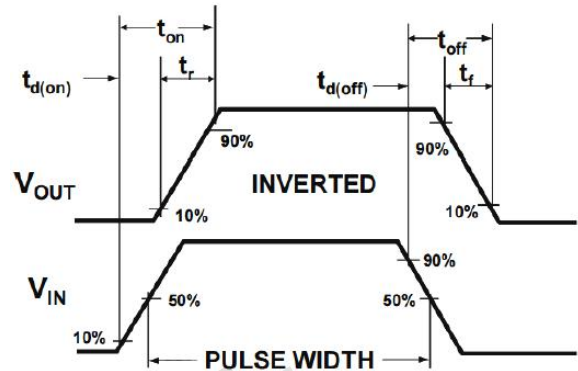

**Figure 2 Switching Waveform**

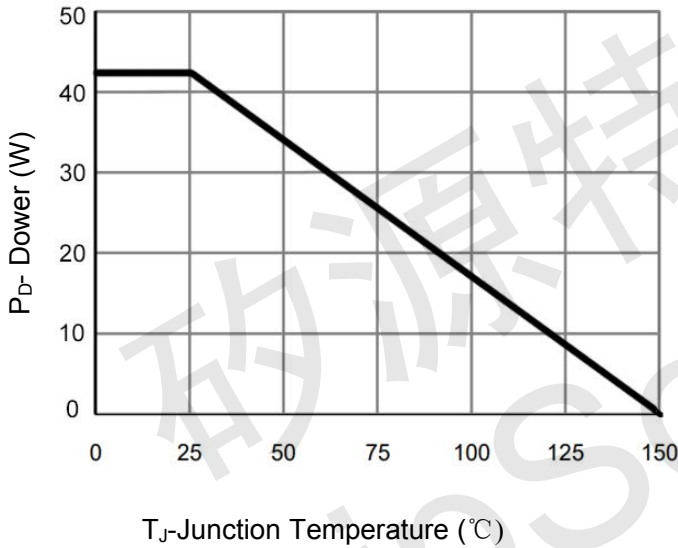

**Figure 3 Power De-rating**

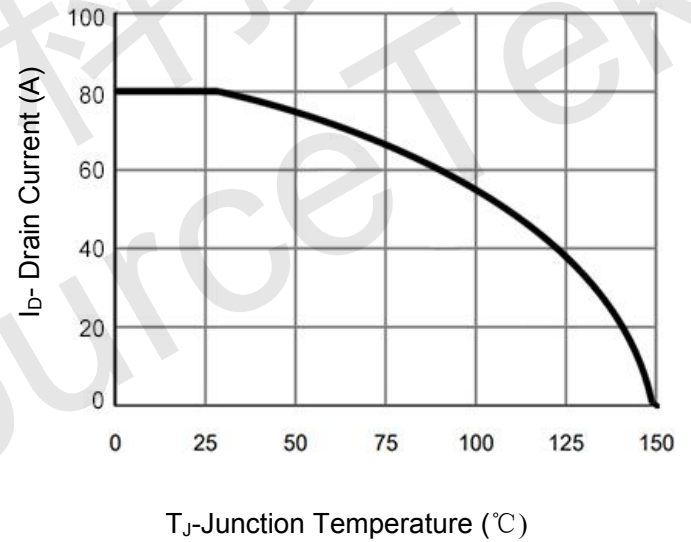

**Figure 4 Drain Current**

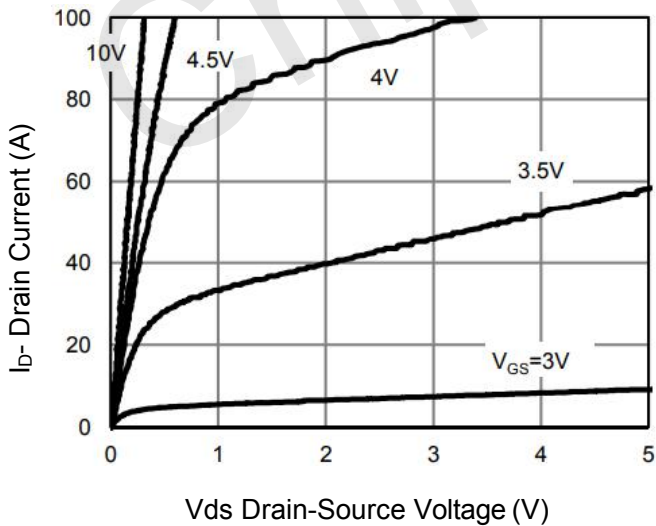

**Figure 5 Output Characteristics**

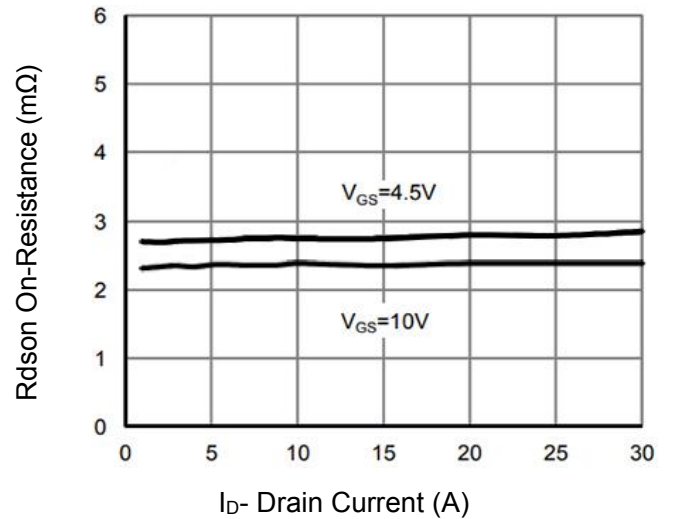

**Figure 6 Rdson vs Drain Current**

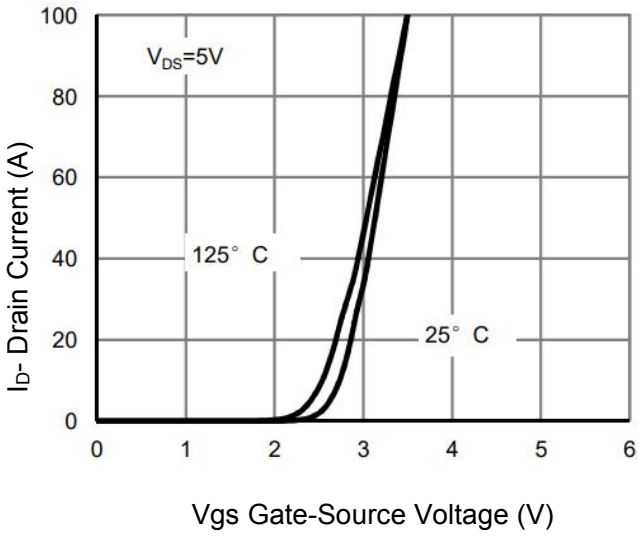

**Figure 7 Transfer Characteristics**

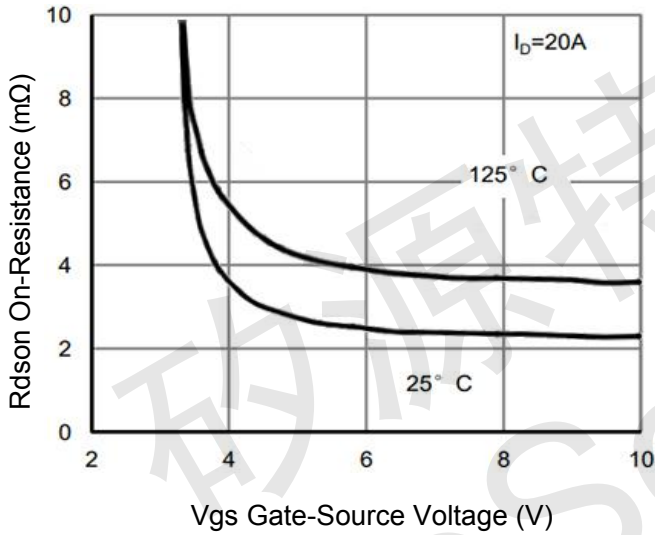

**Figure 9 Rdson vs Vgs**

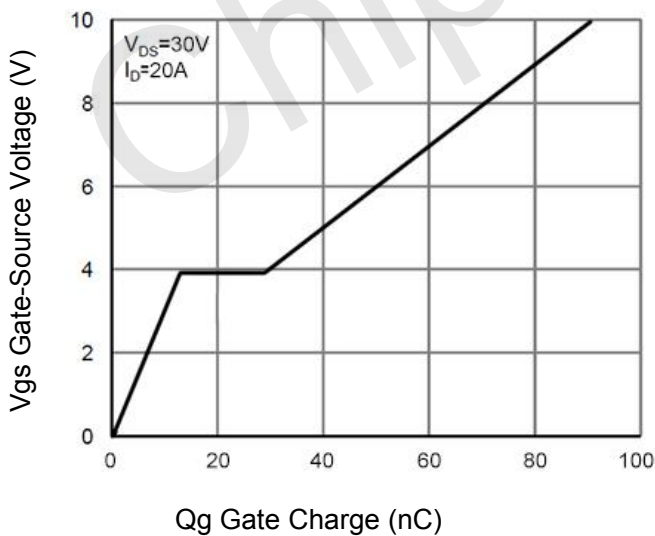

**Figure 11 Gate Charge**

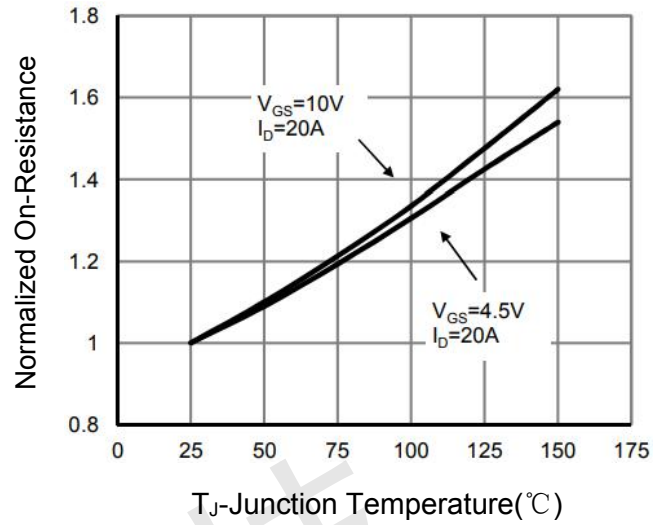

**Figure 8 Rdson vs Junction Temperature**

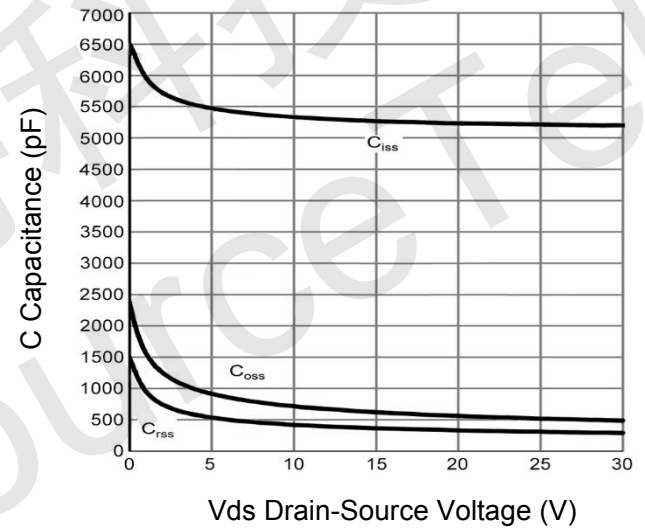

**Figure 10 Capacitance vs Vds**

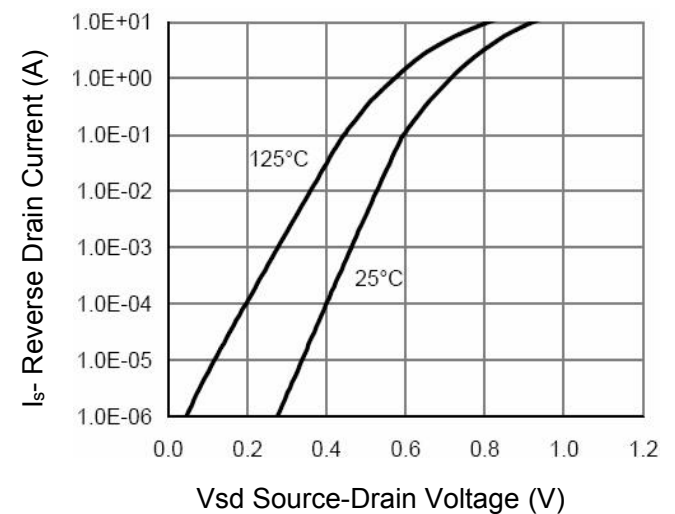

**Figure 12 Source- Drain Diode Forward**

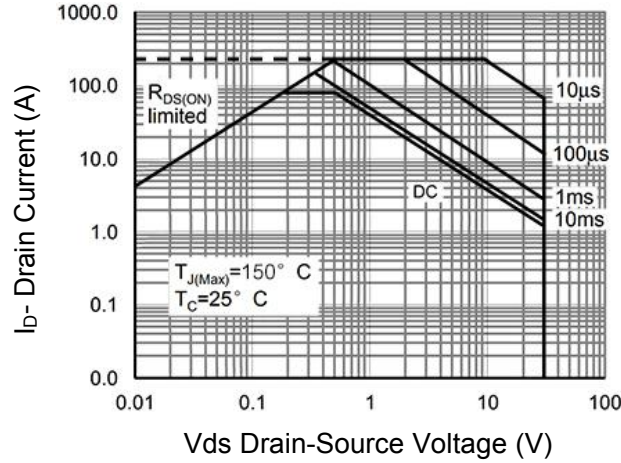

**Figure 13 Safe Operation Area**

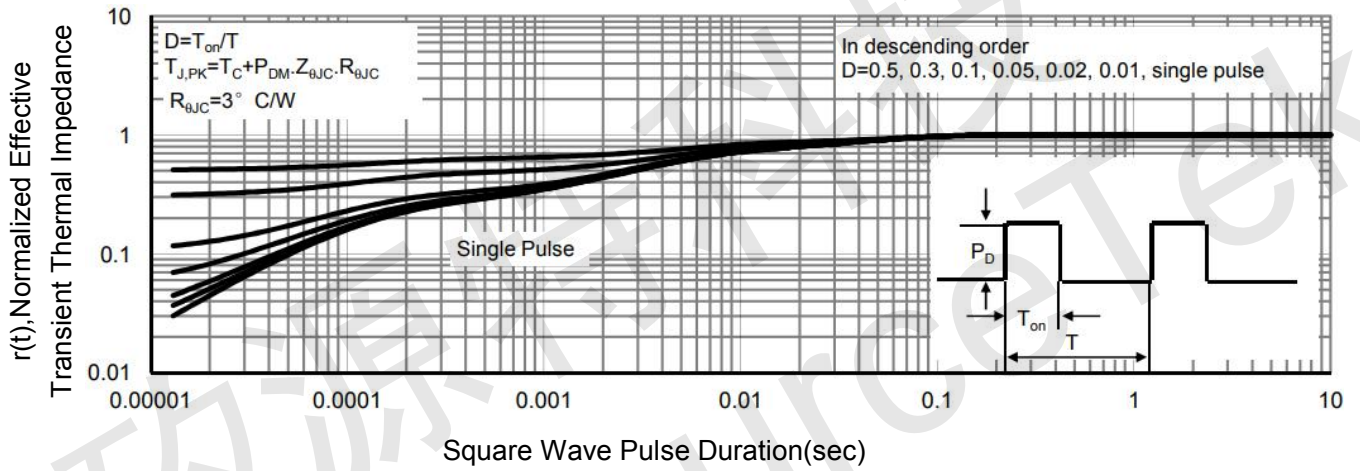
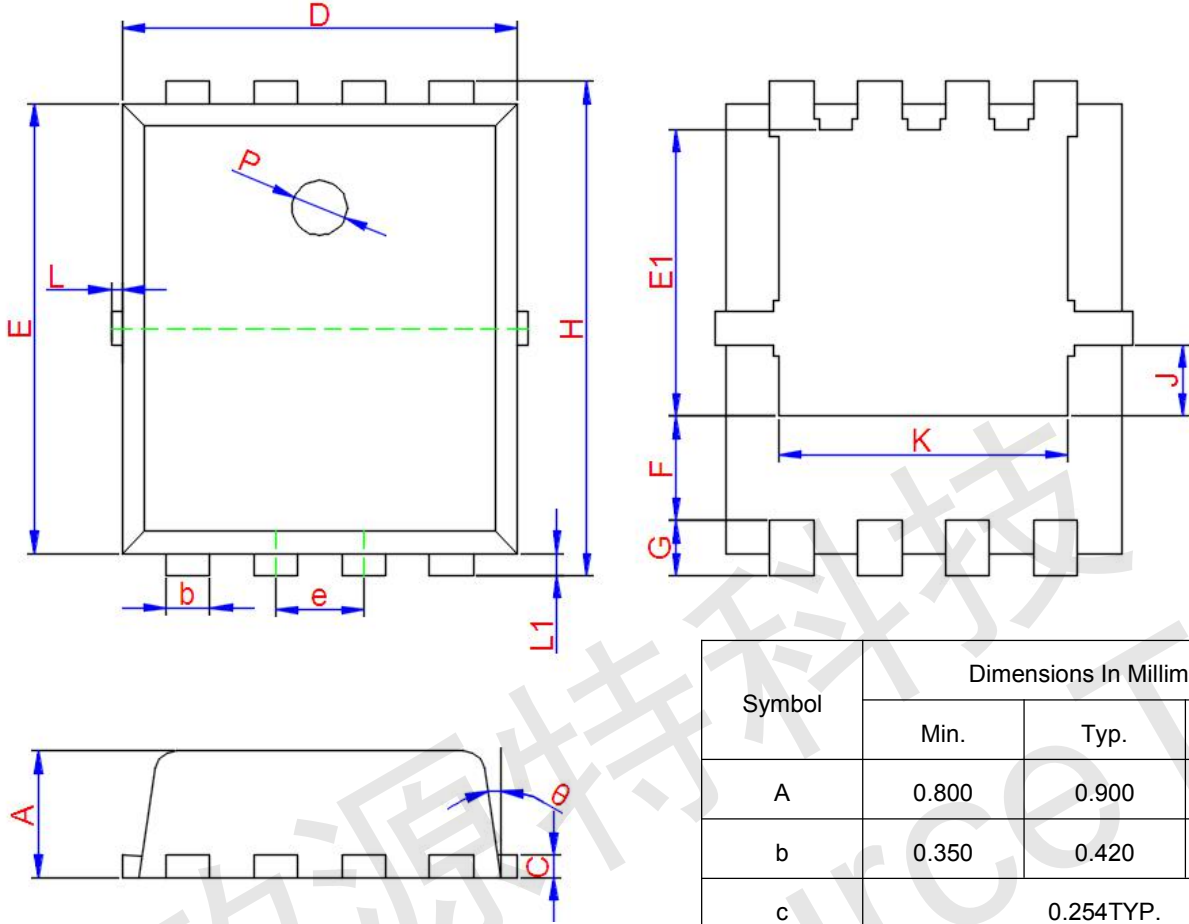

**Figure 14 Normalized Maximum Transient Thermal Impedance**





**DFN5x6-8L Package Information**



Symbol	Dimensions In Millimeters		
	Min.	Typ.	Max.
A	0.800	0.900	1.000
b	0.350	0.420	0.490
c	0.254TYP.		
D	4.900	5.000	5.100
e	1.270TYP.		
E	5.700	5.800	5.900
E1	3.400TYP.		
F	1.400TYP.		
G	0.600TYP.		
H	5.950	6.080	6.200
J	0.950TYP.		
K	4.000TYP.		
L	-	-	0.150
L1	0.100	0.140	0.180
P	1.000TYP.		
θ	6°	10°	14°