



P-Channel Enhancement Mode Power MOSFET

Description

The PED2015M uses advanced trench technology to provide excellent $R_{DS(ON)}$ and low gate charge. It can be used in a wide variety of applications.

General Features

- $V_{DS} = -20V$, $I_D = -40A$

$R_{DS(ON)} < 11m\Omega @ V_{GS}=-4.5V$

$R_{DS(ON)} < 15m\Omega @ V_{GS}=-2.5V$

- High Power and current handing capability
- Lead free product is acquired
- Surface Mount Package

Application

- PWM applications
- Load switch
- Power management

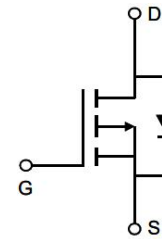

Schematic diagram

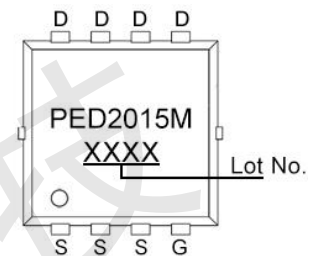

Marking and pin assignment

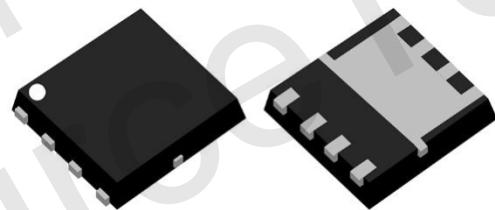

PDFN3.3x3.3-8L

Absolute Maximum Ratings (TC=25°C unless otherwise noted)

Parameter	Symbol	Rating	Unit
Drain-Source Voltage	V_{DS}	-20	V
Gate-Source Voltage	V_{GS}	± 12	V
Drain Current-Continuous	I_D	-40	A
Drain Current-Continuous (TC=100°C)	I_D	-27	A
Pulsed Drain Current (Note 1)	I_{DM}	-100	A
Avalanche Current	I_{AS}	-22	A
Avalanche Energy (L=0.5mH)	E_{AS}	121	mJ
Maximum Power Dissipation	P_D	29	W
Operating Junction and Storage Temperature Range	T_J, T_{STG}	-55 To 150	°C

Thermal Characteristic

Thermal Resistance, Junction-to-Case	$R_{\theta JC}$	4.3	°C/W
--------------------------------------	-----------------	-----	------



Electrical Characteristics (TC=25°C unless otherwise noted)

Parameter	Symbol	Condition	Min	Typ	Max	Unit
Off Characteristics						
Drain-Source Breakdown Voltage	BV_{DSS}	$V_{GS}=0V, I_D=-250\mu A$	-20	-	-	V
Zero Gate Voltage Drain Current	I_{DSS}	$V_{DS}=-20V, V_{GS}=0V$	-	-	-1	μA
Gate-Body Leakage Current	I_{GSS}	$V_{GS}=\pm 12V, V_{DS}=0V$	-	-	± 100	nA
On Characteristics (Note 3)						
Gate Threshold Voltage	$V_{GS(th)}$	$V_{DS}=V_{GS}, I_D=-250\mu A$	-0.4	-0.7	-1	V
Drain-Source On-State Resistance	$R_{DS(on)}$	$V_{GS}=-4.5V, I_D=-7A$	-	8.5	11	m Ω
		$V_{GS}=-2.5V, I_D=-5A$	-	11	15	m Ω
sForward Transconductance	g_{FS}	$V_{DS}=-5V, I_D=-10A$	-	38	-	S
Dynamic Characteristics (Note 3)						
Input Capacitance	C_{iss}	$V_{DS}=-10V, V_{GS}=0V,$ $F=1.0MHz$	-	3650	-	pF
Output Capacitance	C_{oss}		-	520	-	pF
Reverse Transfer Capacitance (Note 4)	C_{rss}		-	370	-	pF
Switching Characteristics						
Turn-on Delay Time	$t_{d(on)}$	$V_{DD}=-10V, R_L=1\Omega,$ $V_{GS}=-10V, R_G=3\Omega$	-	15	-	nS
Turn-on Rise Time	t_r		-	43	-	nS
Turn-Off Delay Time	$t_{d(off)}$		-	158	-	nS
Turn-Off Fall Time	t_f		-	90	-	nS
Total Gate Charge	Q_g	$V_{DS}=-10V, I_D=-10A,$ $V_{GS}=-4.5V$	-	34	-	nC
Gate-Source Charge	Q_{gs}		-	7	-	nC
Gate-Drain Charge	Q_{gd}		-	9	-	nC
Drain-Source Diode Characteristics						
Diode Forward Voltage (Note 3)	V_{SD}	$V_{GS}=0V, I_S=-1A$	-	-	-1.2	V
Diode Forward Current (Note 2)	I_S		-	-	-30	A

Notes:

1. Repetitive Rating: Pulse width limited by maximum junction temperature.
2. Surface Mounted on FR4 Board, $t \leq 10$ sec.
3. Pulse Test: Pulse Width $\leq 300\mu s$, Duty Cycle $\leq 2\%$.
4. Guaranteed by design, not subject to product.



Typical Electrical and Thermal Characteristics

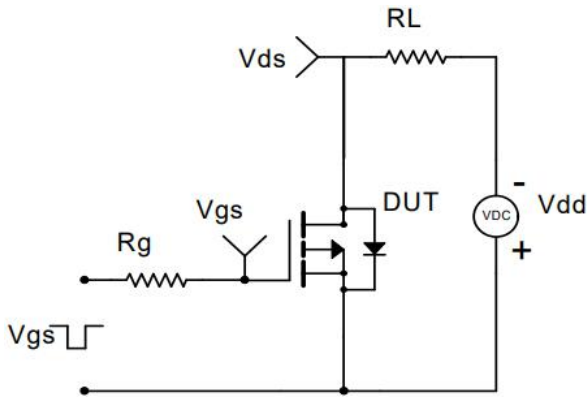

Figure 1 Switching Test Circuit

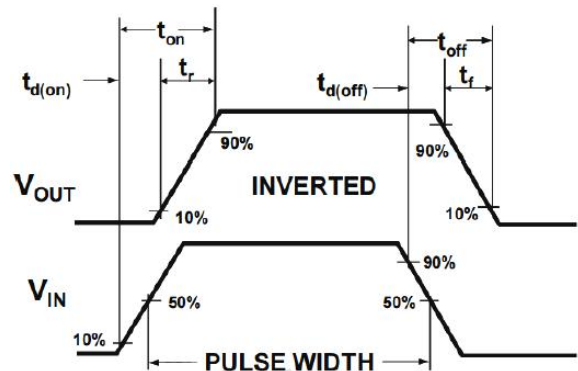

Figure 2 Switching Waveform

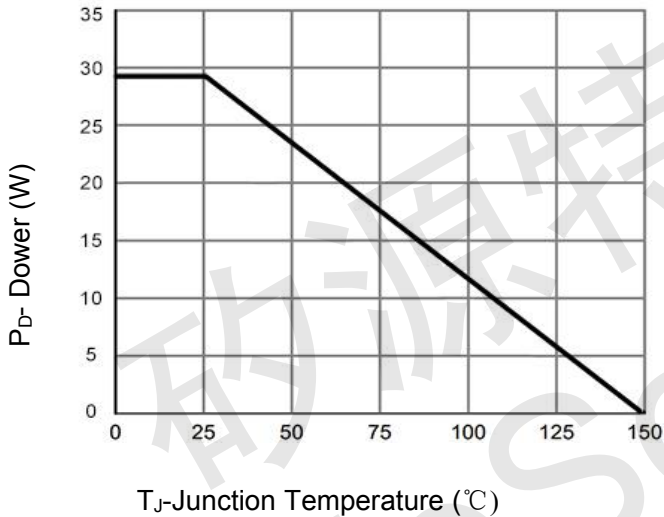

Figure 3 Power De-rating

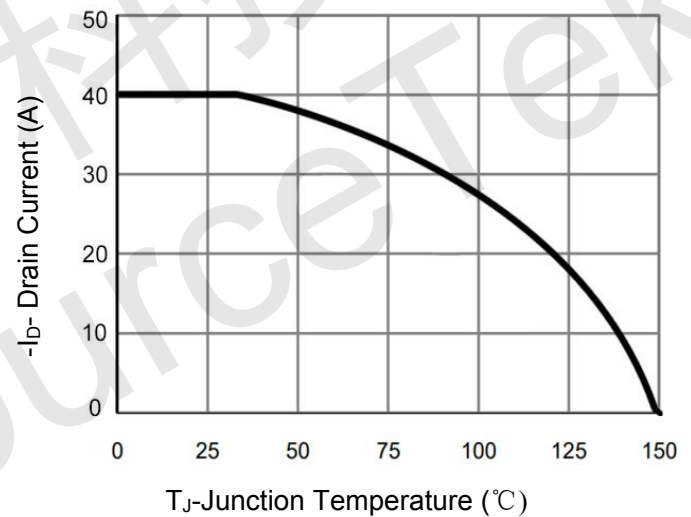

Figure 4 Drain Current

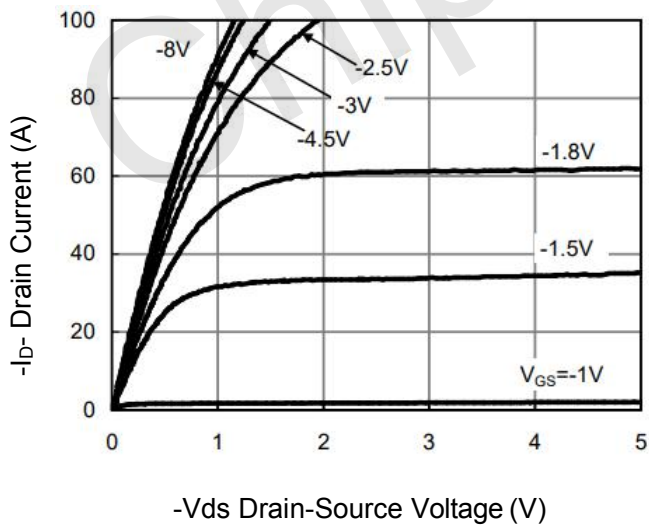

Figure 5 Output Characteristics

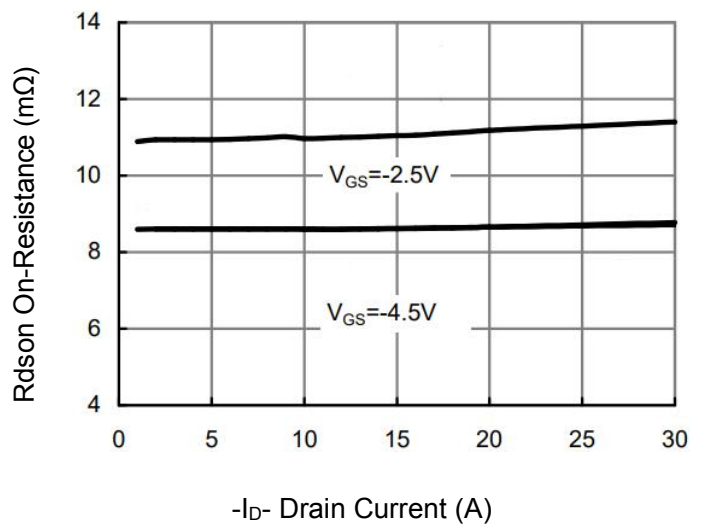

Figure 6 Rds(on) vs Drain Current

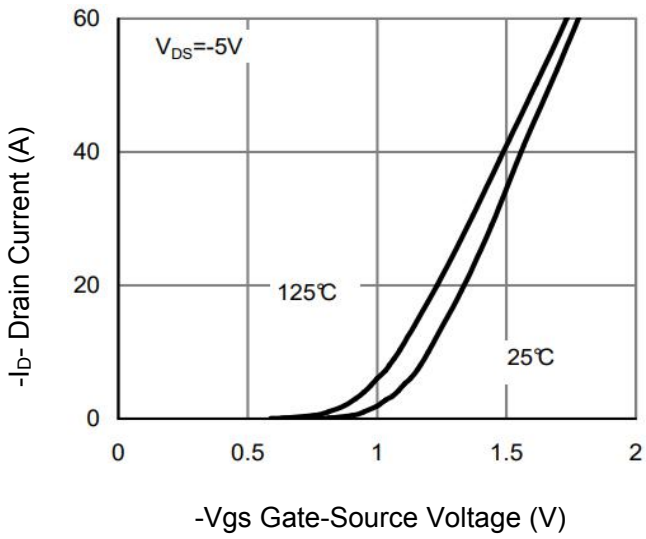

Figure 7 Transfer Characteristics

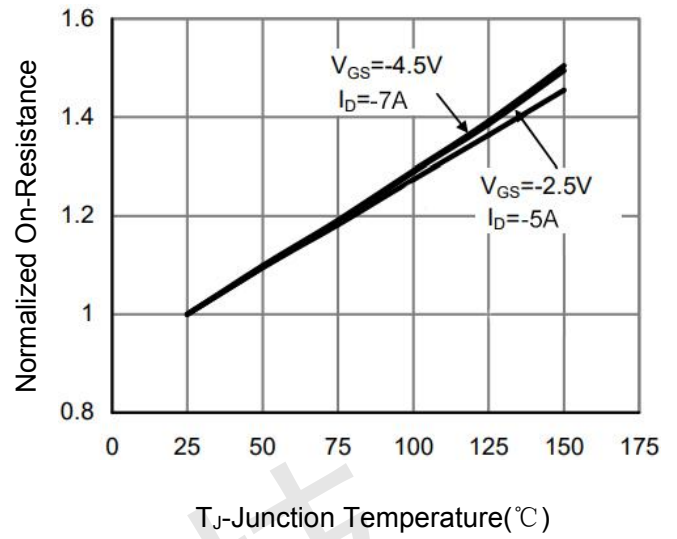

Figure 8 Rdson vs Junction Temperature

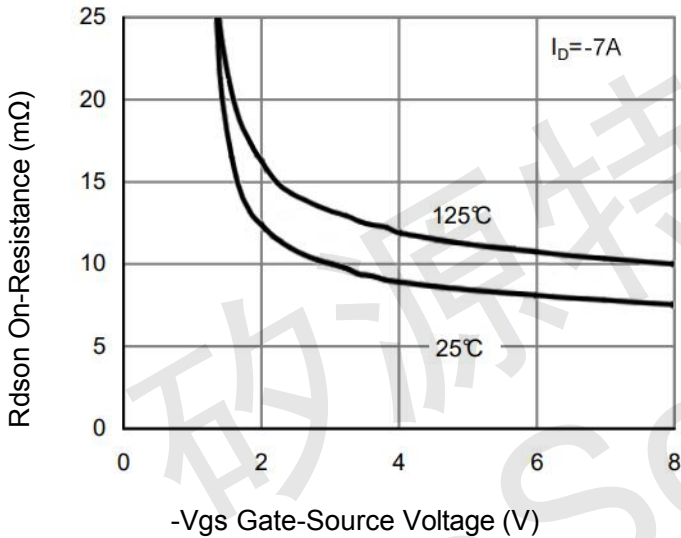

Figure 9 Rdson vs Vgs

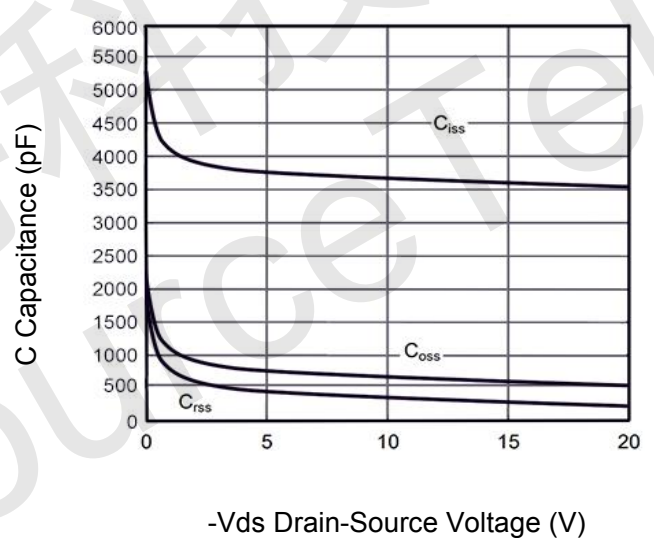

Figure 10 Capacitance vs Vds

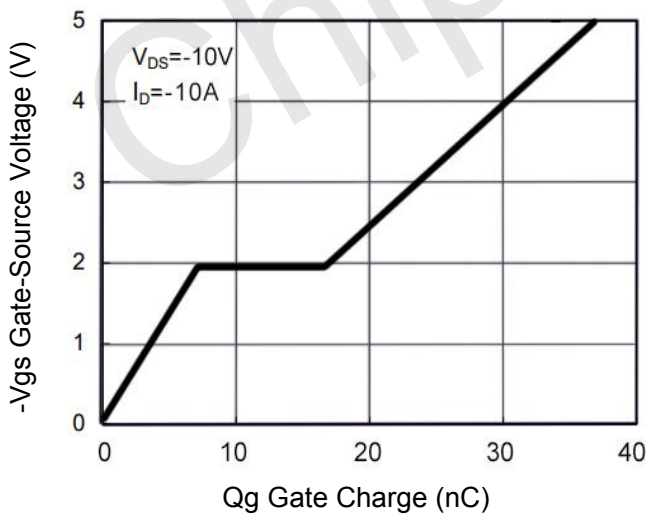

Figure 11 Gate Charge

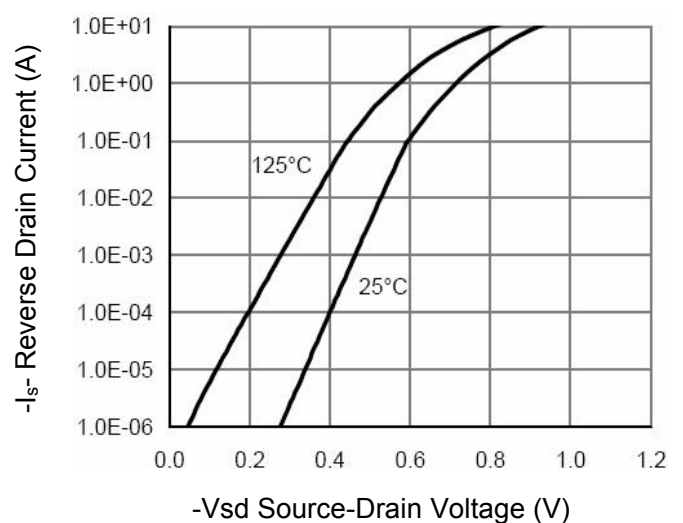

Figure 12 Source- Drain Diode Forward

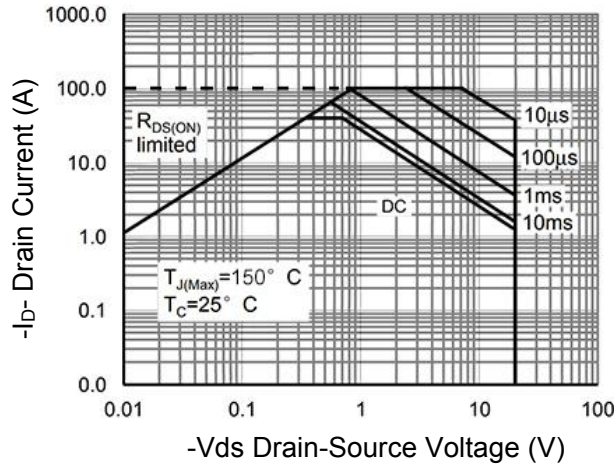

Figure 13 Safe Operation Area

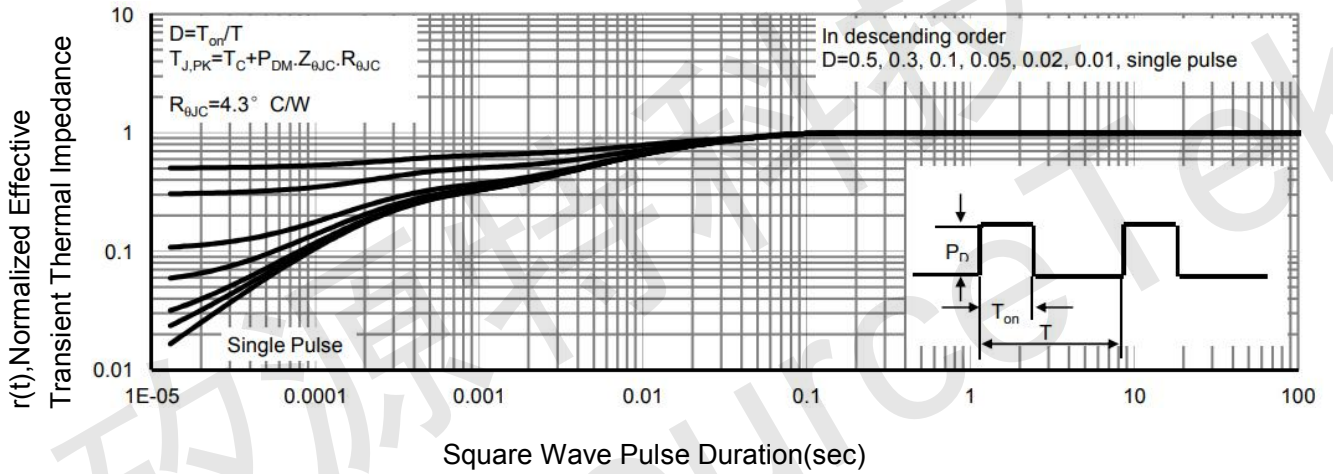
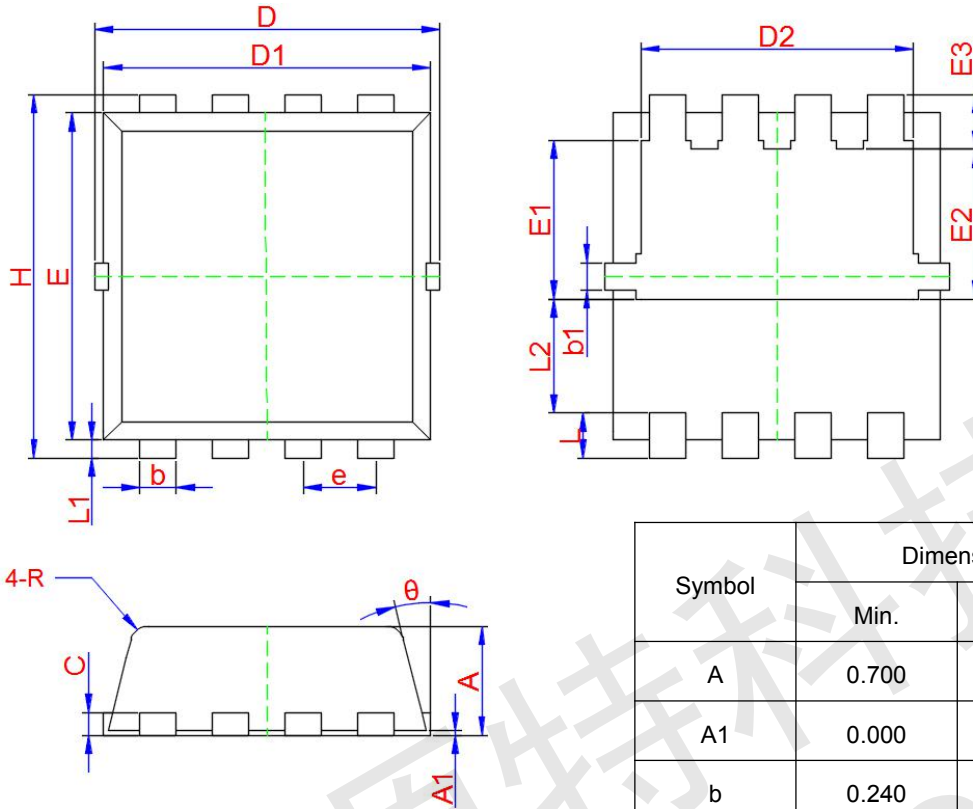

Figure 14 Normalized Maximum Transient Thermal Impedance



PDFN3.3x3.3-8L Package Information



Symbol	Dimensions In Millimeters		
	Min.	Typ.	Max.
A	0.700	0.800	0.900
A1	0.000	0.030	0.050
b	0.240	0.300	0.350
b1	0.080	0.130	0.180
c	0.152 TYP.		
D	3.250	3.320	3.400
D1	3.050	3.150	3.250
D2	2.400	2.500	2.600
E	3.000	3.100	3.200
E1	1.350	1.450	1.550
E2	1.200	1.300	1.400
E3	0.400	0.500	0.600
e	0.650 TYP.		
H	3.200	3.300	3.400
L	0.300	0.400	0.500
L1	0.100	0.150	0.200
L2	1.130 TYP.		
R	0.200 TYP.		
θ	6°	10°	14°