



## N-Channel Enhancement Mode Power MOSFET

### Description

The PE8126HM1 uses advanced trench technology to provide excellent  $R_{DS(ON)}$  and low gate charge. It can be used in a wide variety of applications. It is ESD protected.

### General Features

- $V_{DS} > 12V$ ,  $I_D = 26A$

$$R_{DS(ON)} < 3.2m\Omega @ V_{GS}=4.5V$$

$$R_{DS(ON)} < 3.5m\Omega @ V_{GS}=3.8V$$

$$R_{DS(ON)} < 4.0m\Omega @ V_{GS}=3.1V$$

$$R_{DS(ON)} < 5.2m\Omega @ V_{GS}=2.5V$$

ESD Rating: 4000V HBM

- High Power and current handing capability
- Lead free product is acquired
- Surface Mount Package

### Application

- PWM applications
- Load switch
- Power management

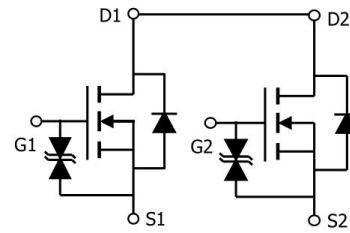

Schematic diagram

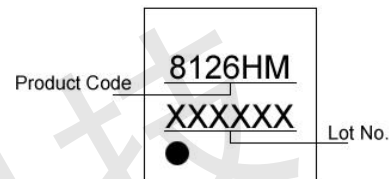

Marking

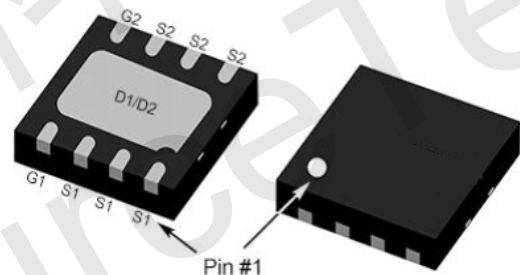

DFN3x3-8L

### Absolute Maximum Ratings (TA=25°C unless otherwise noted)

Parameter	Symbol	Rating	Unit
Drain-Source Voltage	$V_{DS}$	12	V
Gate-Source Voltage	$V_{GS}$	±8	V
Drain Current-Continuous	$I_D$	TA=25°C	26
		TA=70°C	16
Pulsed Drain Current (Note 1)	$I_{DM}$	80	A
Maximum Power Dissipation	$P_D$	3.6	W
Operating Junction and Storage Temperature Range	$T_J, T_{STG}$	-55 To 150	°C

### Thermal Characteristic

Thermal Resistance, Junction-to-Ambient (Note 2)	$R_{\theta JA}$	35	°C/W
--------------------------------------------------	-----------------	----	------



**Electrical Characteristics (TA=25°C unless otherwise noted)**

Parameter	Symbol	Condition	Min	Typ	Max	Unit
<b>Off Characteristics</b>						
Drain-Source Breakdown Voltage	$BV_{DSS}$	$V_{GS}=0V, I_D=250\mu A$	12	14	-	V
Zero Gate Voltage Drain Current	$I_{DSS}$	$V_{DS}=12V, V_{GS}=0V$	-	-	1	$\mu A$
Gate-Body Leakage Current	$I_{GSS}$	$V_{GS}=\pm 6V, V_{DS}=0V$	-	-	$\pm 5$	$\mu A$
<b>On Characteristics (Note 3)</b>						
Gate Threshold Voltage	$V_{GS(th)}$	$V_{DS}=V_{GS}, I_D=250\mu A$	0.4	0.65	0.95	V
Drain-Source On-State Resistance	$R_{DS(on)}$	$V_{GS}=4.5V, I_D=8A$	2.3	2.7	3.2	m $\Omega$
		$V_{GS}=3.8V, I_D=7A$	2.5	2.9	3.5	m $\Omega$
		$V_{GS}=3.1V, I_D=6A$	2.7	3.3	4.0	m $\Omega$
		$V_{GS}=2.5V, I_D=6A$	3.0	3.8	5.2	m $\Omega$
Forward Transconductance	$g_{FS}$	$V_{DS}=5V, I_D=5A$	-	34	-	S
<b>Dynamic Characteristics (Note 4)</b>						
Input Capacitance	$C_{iss}$	$V_{DS}=10V, V_{GS}=0V,$ $F=1.0MHz$	-	3100	-	pF
Output Capacitance	$C_{oss}$		-	720	-	pF
Reverse Transfer Capacitance (Note 4)	$C_{riss}$		-	690	-	pF
Gate Resistance	$R_g$	$V_{DS}=0V, V_{GS}=0V, F=1.0MHz$	-	4	-	$\Omega$
<b>Switching Characteristics</b>						
Turn-on Delay Time	$t_{d(on)}$	$V_{DD}=10V, R_L=1\Omega,$ $V_{GS}=4.5V, R_G=3\Omega$	-	15	-	nS
Turn-on Rise Time	$t_r$		-	30	-	nS
Turn-Off Delay Time	$t_{d(off)}$		-	52	-	nS
Turn-Off Fall Time	$t_f$		-	13	-	nS
Total Gate Charge	$Q_g$	$V_{DS}=10V, I_D=7A, V_{GS}=4.5V$	-	26	-	nC
Gate-Source Charge	$Q_{gs}$		-	2.8	-	nC
Gate-Drain Charge	$Q_{gd}$		-	8	-	nC
<b>Drain-Source Diode Characteristics</b>						
Diode Forward Voltage (Note 3)	$V_{SD}$	$V_{GS}=0V, I_S=1A$	-	-	1.2	V
Diode Forward Current (Note 2)	$I_S$		-	-	26	A

**Notes:**

1. Repetitive Rating: Pulse width limited by maximum junction temperature.
2. Surface Mounted on FR4 Board,  $t \leq 10$  sec.
3. Pulse Test: Pulse Width  $\leq 300\mu s$ , Duty Cycle  $\leq 2\%$ .
4. Guaranteed by design, not subject to product.



**Typical Electrical and Thermal Characteristics**

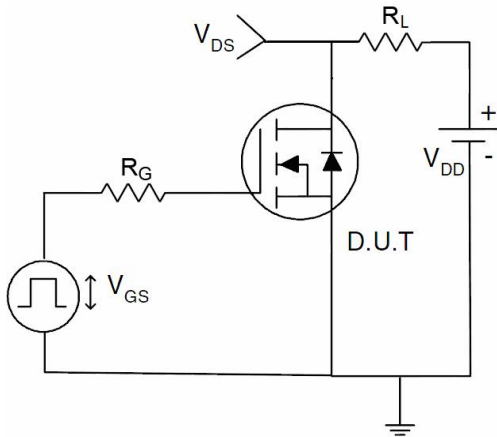

**Figure 1 Switching Test Circuit**



**Figure 2 Switching Waveform**

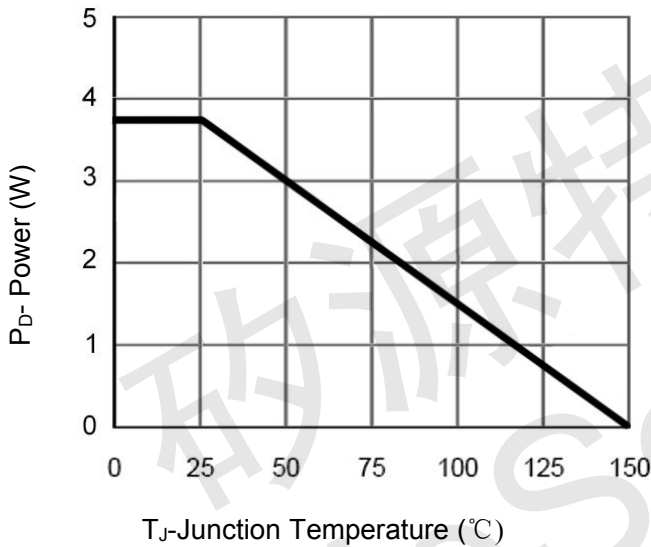

**Figure 3 Power Dissipation**

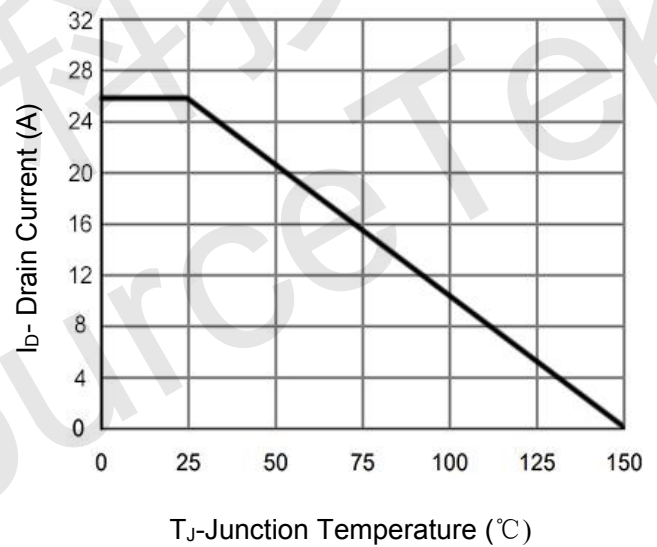

**Figure 4 Drain Current**

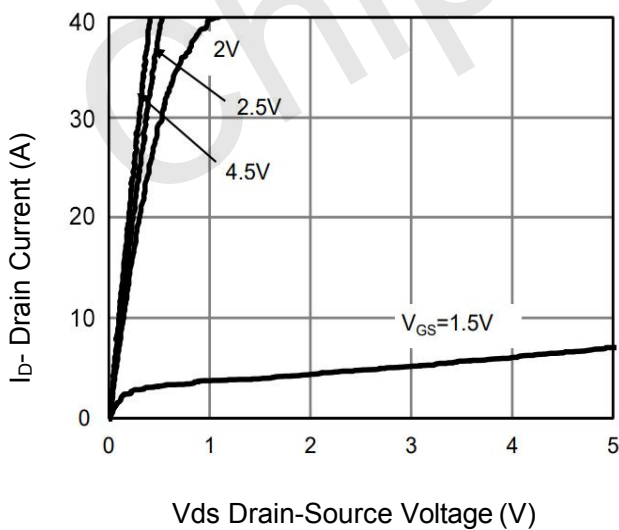

**Figure 5 Output Characteristics**

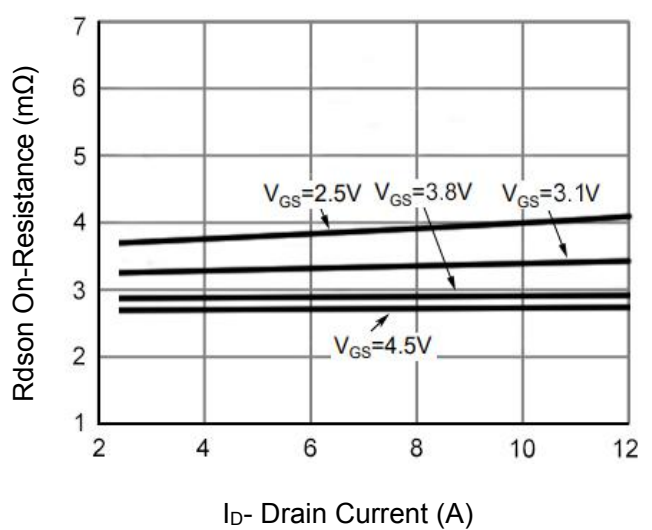

**Figure 6 R<sub>dson</sub> vs Drain Current**

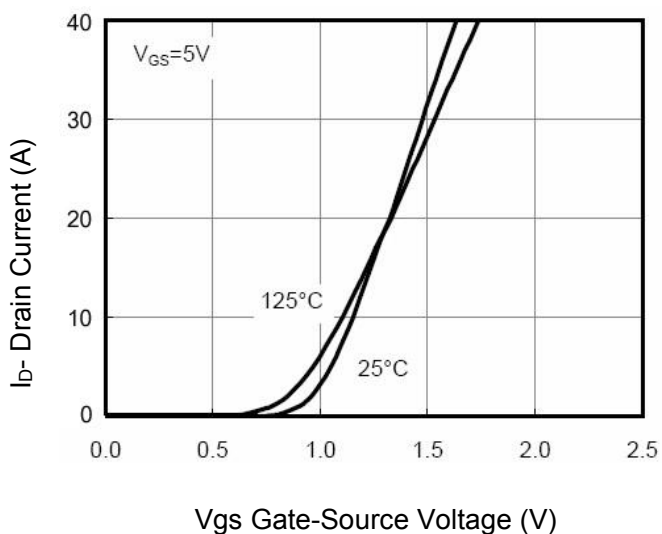

Figure 7 Transfer Characteristics

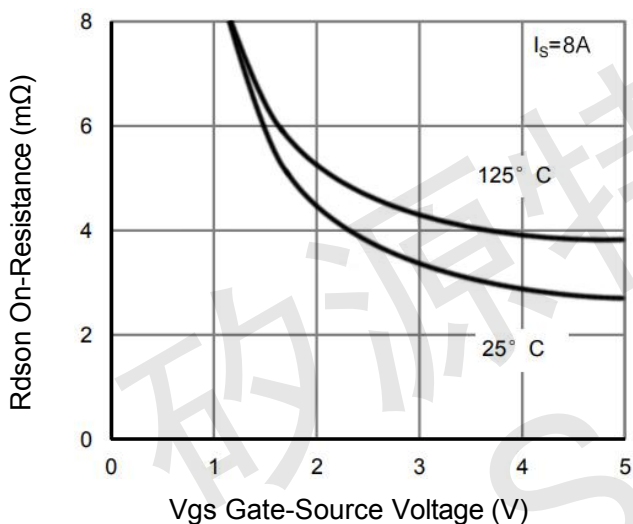

Figure 9 Rdson vs Vgs

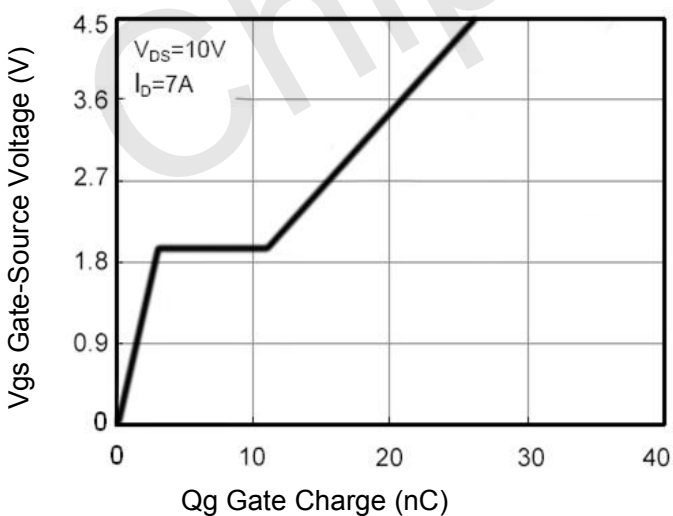

Figure 11 Gate Charge

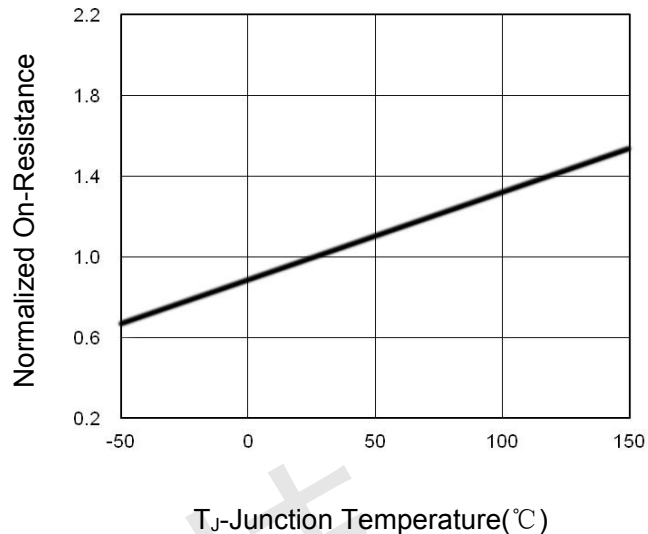

Figure 8 Rdson vs Junction Temperature

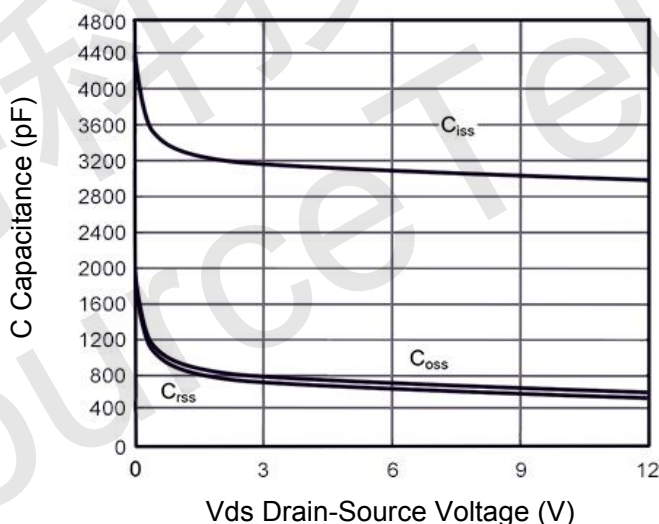

Figure 10 Capacitance vs Vds

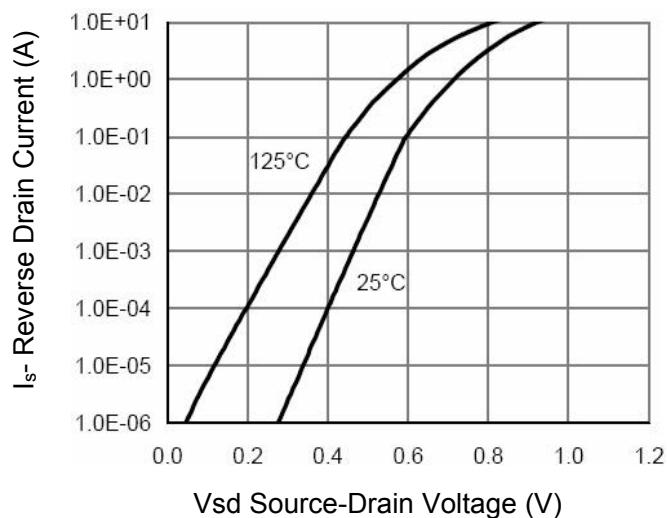

Figure 12 Source- Drain Diode Forward

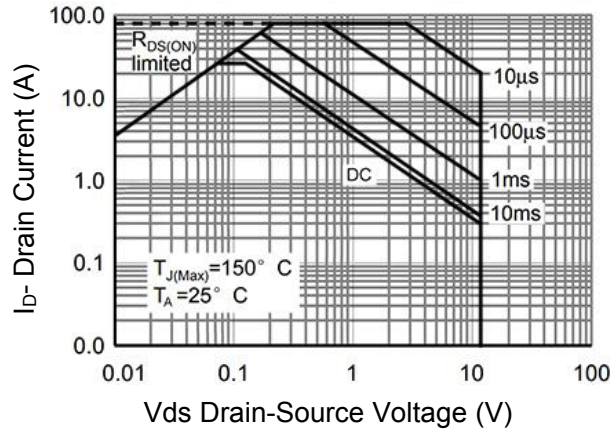

Figure 13 Safe Operation Area

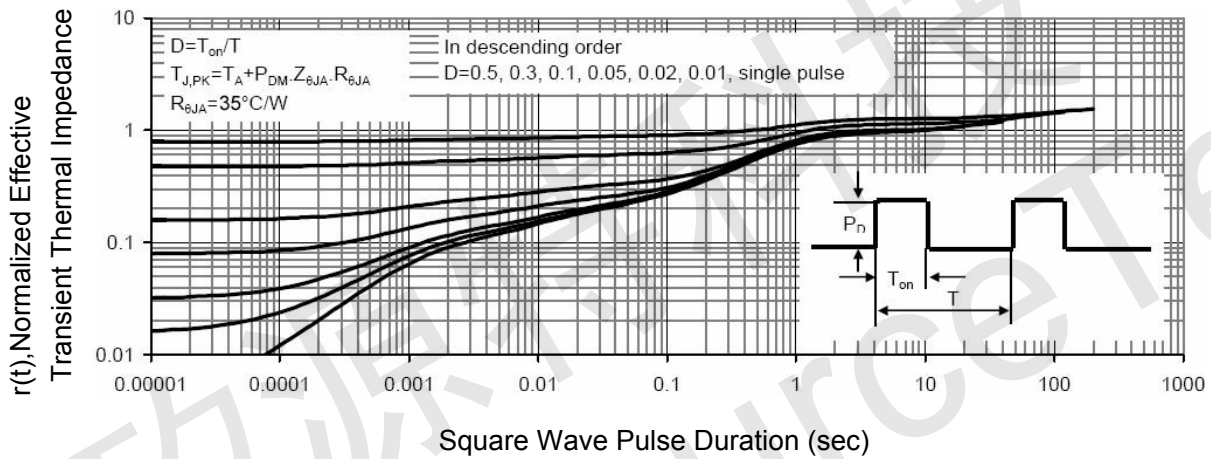
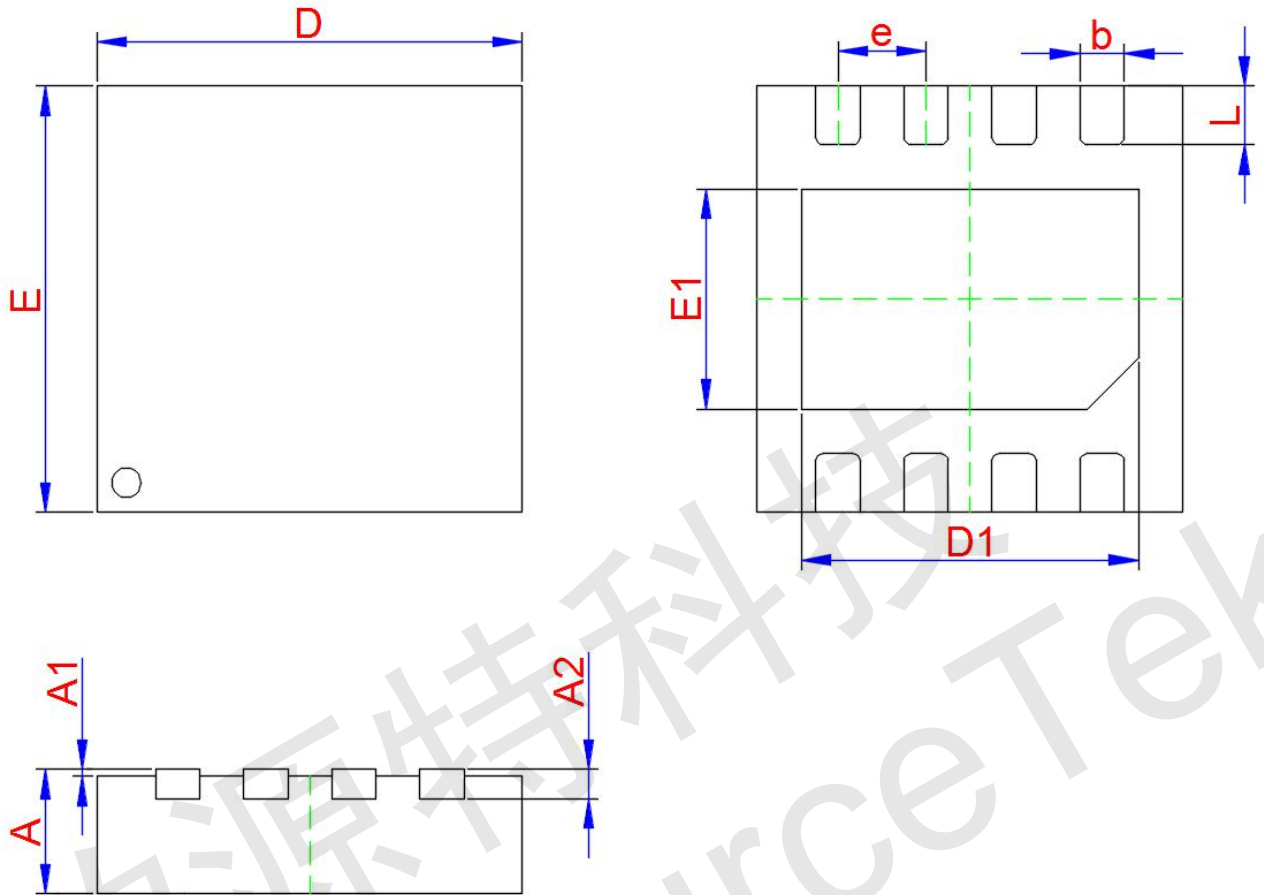

Figure 14 Normalized Maximum Transient Thermal Impedance



**DFN3x3-8L Package Information**



Symbol	Dimensions In Millimeters		
	Min.	Typ.	Max.
A	0.700	0.750	0.800
A1	0.000	0.020	0.050
A2	0.203		
b	0.250	0.300	0.350
D	2.924	3.000	3.076
D1	2.200	2.300	2.400
E	2.924	3.000	3.076
E1	1.400	1.500	1.600
e	0.650 TYP.		
L	0.350	0.400	0.450