



### PE5N100Q N-Channel Enhancement Mode Power MOSFET

#### PE5N100Q Description

The PE5N100Q uses deep trench technology to provide excellent  $R_{DS(ON)}$  and low gate charge. It can be used in a wide variety of applications.

#### PE5N100Q General Features

- $V_{DS} = 1000V$ ,  $I_D = 5A$
- $R_{DS(ON)} < 2.9\Omega$  @  $V_{GS}=10V$

- Gate Charge Minimized
- Fast Switching and High-efficiency
- Lead free product is acquired

#### PE5N100Q Application

- AC-DC application
- Power supply

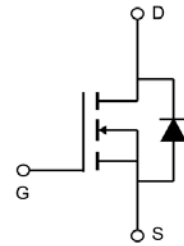

Schematic diagram

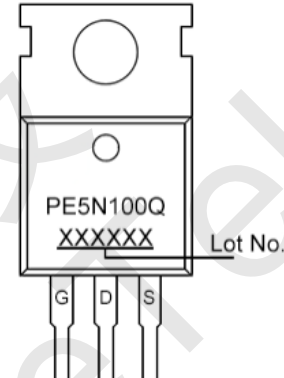

Marking and pin assignment

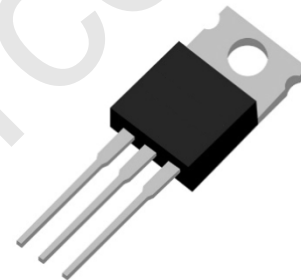

TO-220

#### PE5N100Q Absolute Maximum Ratings (TC=25°C unless otherwise noted)

Parameter	Symbol	Rating	Unit
Drain-Source Voltage	$V_{DS}$	1000	V
Gate-Source Voltage	$V_{GS}$	$\pm 30$	V
Drain Current-Continuous	$I_D$	5	A
Drain Current-Continuous (TC=100°C)	$I_D(TC=100^\circ C)$	3.1	A
Pulsed Drain Current (Note 1)	$I_{DM}$	15.2	A
Maximum Power Dissipation (TC=100°C)	$P_D$	30	W
Maximum Power Dissipation (TA=100°C)	$P_D$	2	W
Single Pulsed Avalanche Energy (L=30mH)	$E_{AS}$	183	mJ
Operating Junction and Storage Temperature Range	$T_J, T_{STG}$	-55 To 150	°C

#### PE5N100Q Thermal Characteristic

Thermal Resistance, Junction-to-Case (Note 2)	$R_{\theta JC}$	4.2	°C/W
Thermal Resistance, Junction-to-Ambient (Note 2)	$R_{\theta JA}$	62.5	°C/W



### PE5N100Q Electrical Characteristics (TC=25°C unless otherwise noted)

Parameter	Symbol	Condition	Min	Typ	Max	Unit
<b>Off Characteristics</b>						
Drain-Source Breakdown Voltage	$BV_{DSS}$	$V_{GS}=0V, I_D=250\mu A$	1000	-	-	V
Zero Gate Voltage Drain Current	$I_{DSS}$	$V_{DS}=1000V, V_{GS}=0V$	-	-	10	$\mu A$
Gate-Body Leakage Current	$I_{GSS}$	$V_{GS}=\pm 30V, V_{DS}=0V$	-	-	$\pm 100$	nA
<b>On Characteristics</b> (Note 3)						
Gate Threshold Voltage	$V_{GS(th)}$	$V_{DS}=V_{GS}, I_D=250\mu A$	3	4	5	V
Drain-Source On-State Resistance	$R_{DS(ON)}$	$V_{GS}=10V, I_D=2.5A$	-	2.6	2.9	$\Omega$
Forward Transconductance	$g_{FS}$	$V_{DS}=5V, I_D=2.5A$	-	5	-	S
<b>Dynamic Characteristics</b> (Note 4)						
Input Capacitance	$C_{iss}$	$V_{DS}=25V, V_{GS}=0V,$ $F=1.0MHz$	-	1570	-	pF
Output Capacitance	$C_{oss}$		-	94	-	pF
Reverse Transfer Capacitance (Note 4)	$C_{rss}$		-	3.5	-	pF
Gate Resistance	$R_g$	$F=1.0MHz$	-	2.9	-	$\Omega$
<b>Switching Characteristics</b>						
Turn-on Delay Time	$t_{d(on)}$	$V_{DD}=800V, I_D=5A,$ $V_{GS}=10V, R_G=10\Omega$	-	21	-	nS
Turn-on Rise Time	$t_r$		-	24	-	nS
Turn-Off Delay Time	$t_{d(off)}$		-	33	-	nS
Turn-Off Fall Time	$t_f$		-	52	-	nS
Total Gate Charge	$Q_g$	$V_{DS}=800V, I_D=5A,$ $V_{GS}=10V$	-	25	-	nC
Gate-Source Charge	$Q_{gs}$		-	9.7	-	nC
Gate-Drain Charge	$Q_{gd}$		-	6.3	-	nC
<b>Drain-Source Diode Characteristics</b>						
Diode Forward Voltage (Note 3)	$V_{SD}$	$V_{GS}=0V, I_S=5A$	-	0.85	-	V
Body Diode Reverse Recovery Time	$t_{rr}$	$V_{dd}=100V, I_S=5A,$ $V_{GS}=0V, di/dt=100A/\mu s$	-	570	-	nS
Body Diode Reverse Recovery Charge	$Q_{rr}$		-	4250	-	nC

#### Notes:

1. Repetitive Rating: Pulse width limited by maximum junction temperature.
2. Surface Mounted on FR4 Board,  $t \leq 10$  sec.
3. Pulse Test: Pulse Width  $\leq 300\mu s$ , Duty Cycle  $\leq 2\%$ .
4. Guaranteed by design, not subject to product.



### PE5N100Q Typical Electrical and Thermal Characteristics

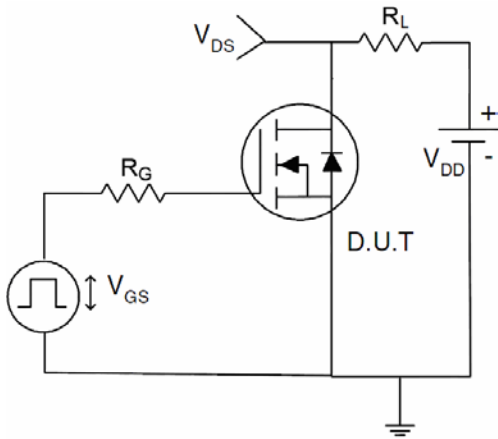

Figure 1 Switching Test Circuit

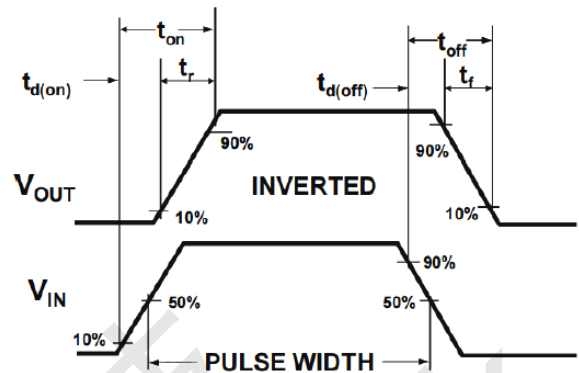

Figure 2 Switching Waveform

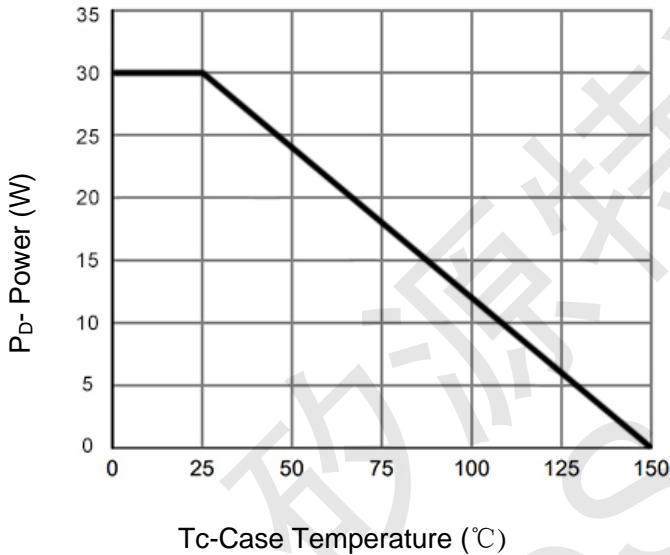

Figure 3 Power De-rating

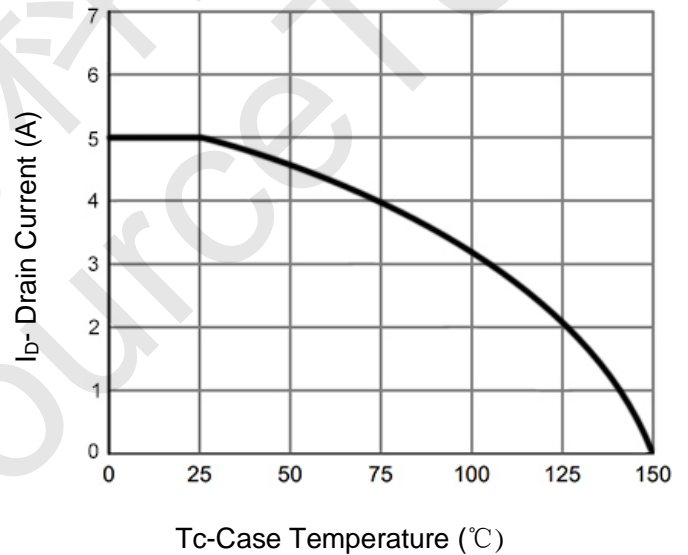

Figure 4 Drain Current

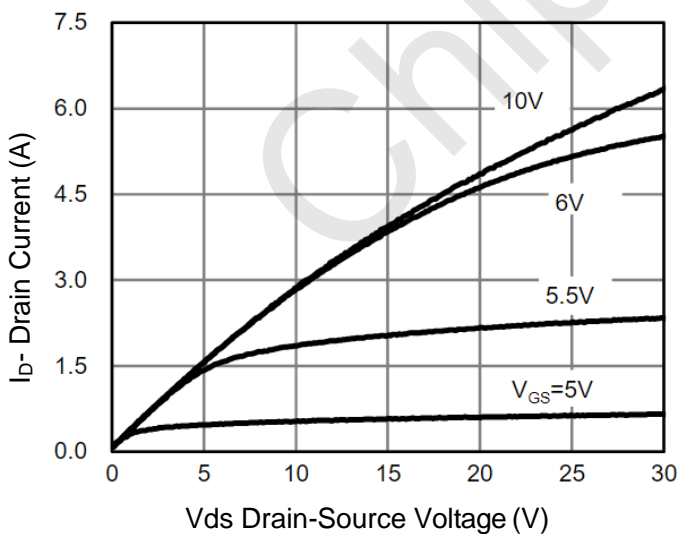

Figure 5 Output Characteristics

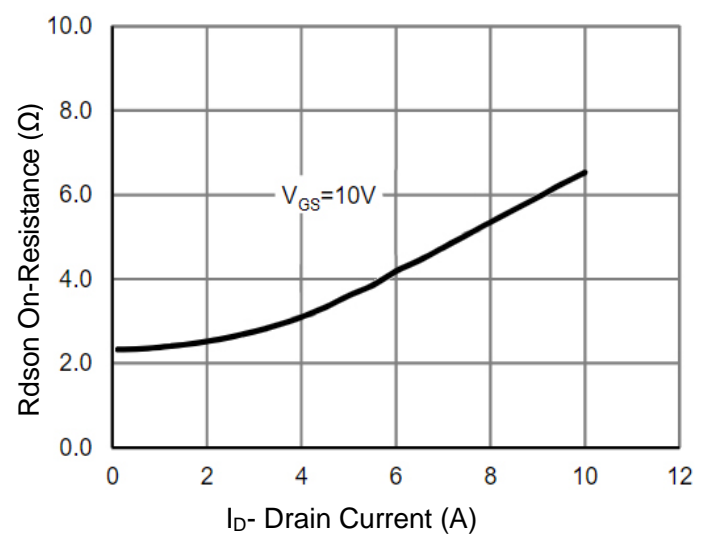

Figure 6 Rdson vs Drain Current

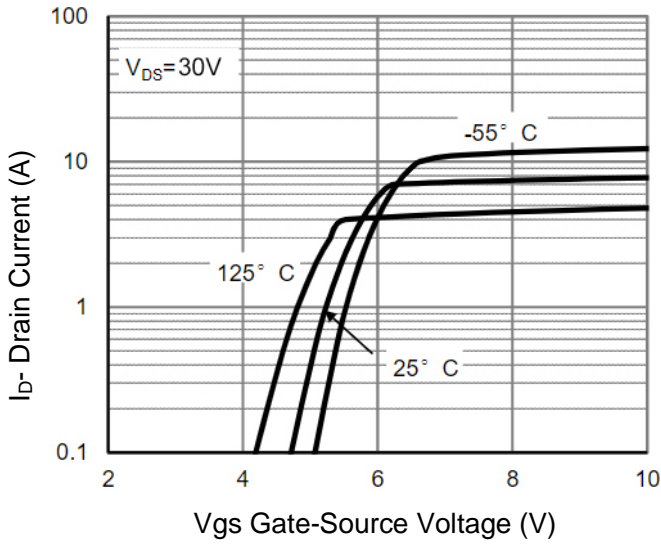

Figure 7 Transfer Characteristics

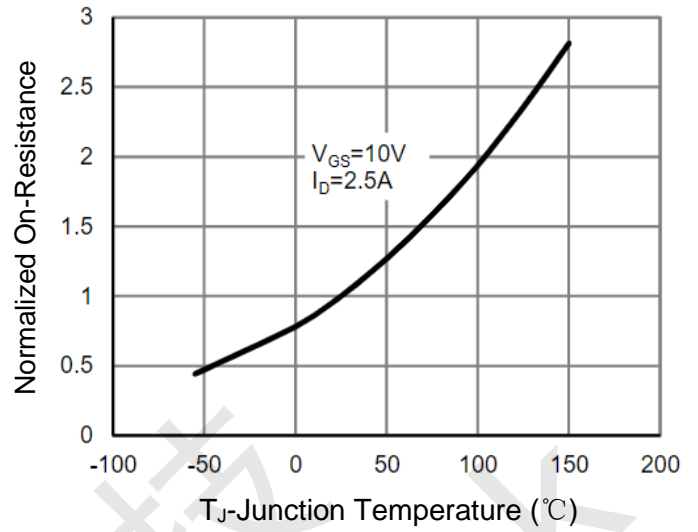

Figure 8 R<sub>DS(on)</sub> vs Junction Temperature

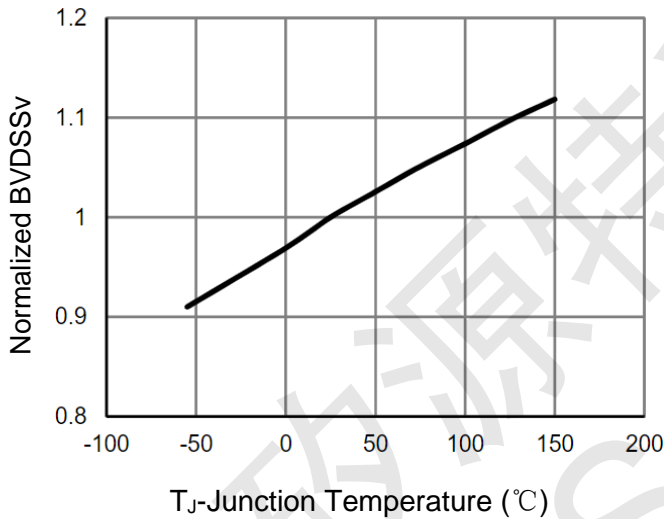

Figure 9 BVDSS vs T<sub>J</sub>

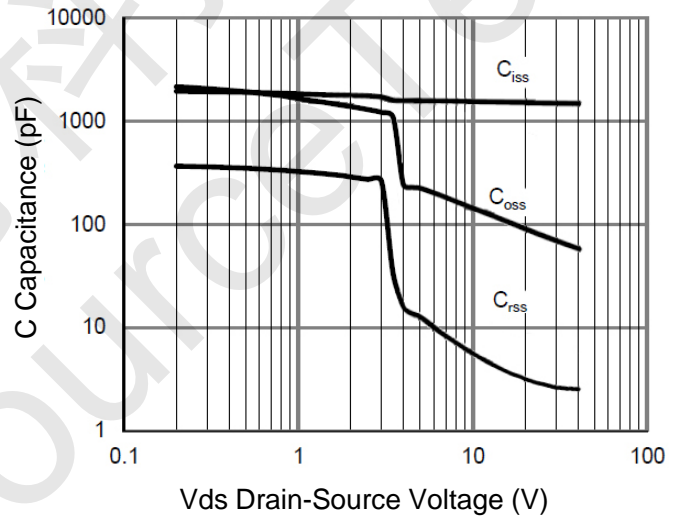

Figure 10 Capacitance vs V<sub>DS</sub>

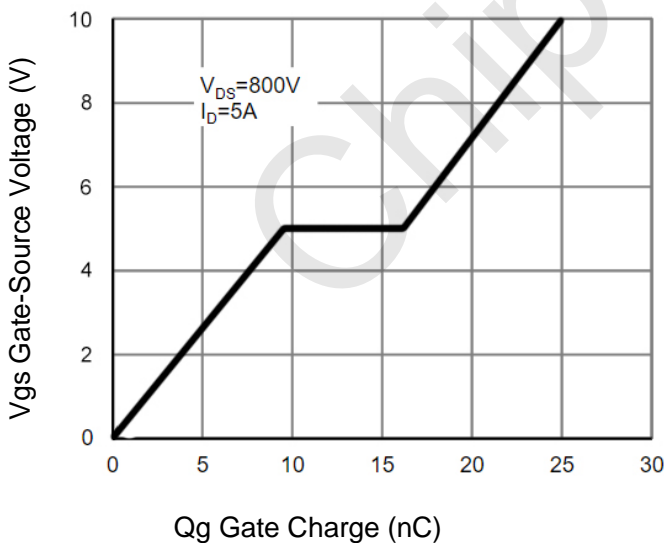

Figure 11 Gate Charge

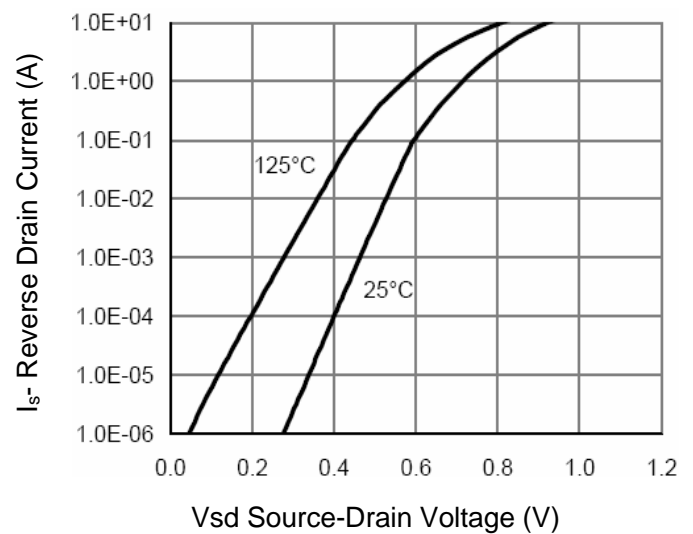

Figure 12 Source- Drain Diode Forward

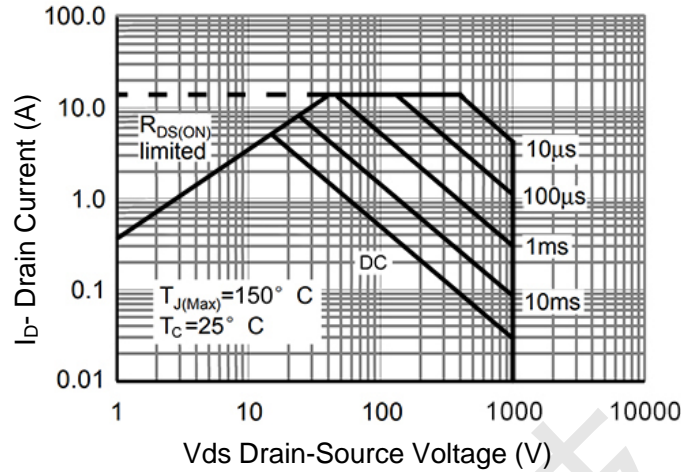

Figure 13 Safe Operation Area

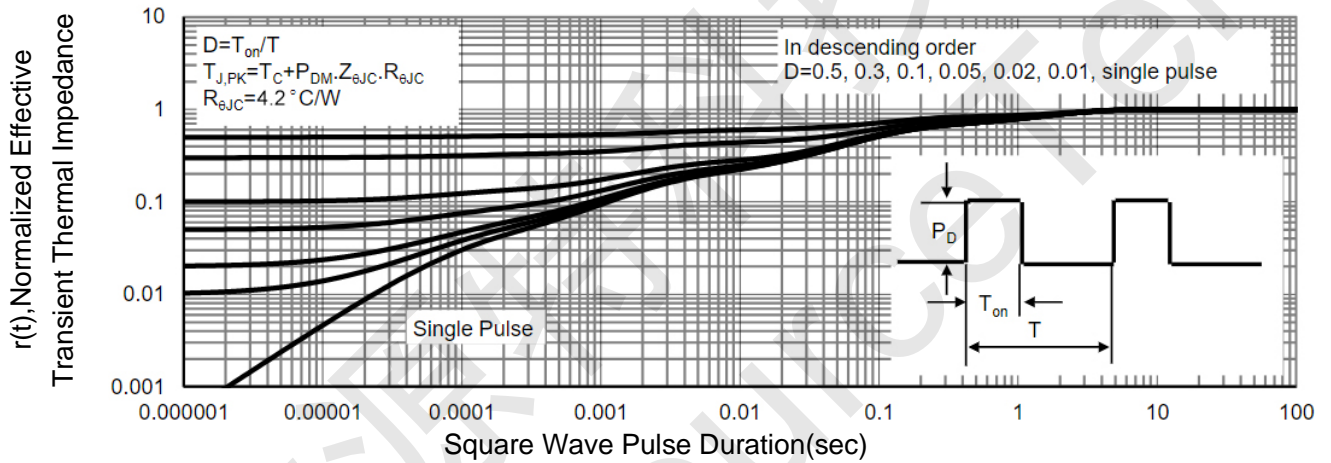
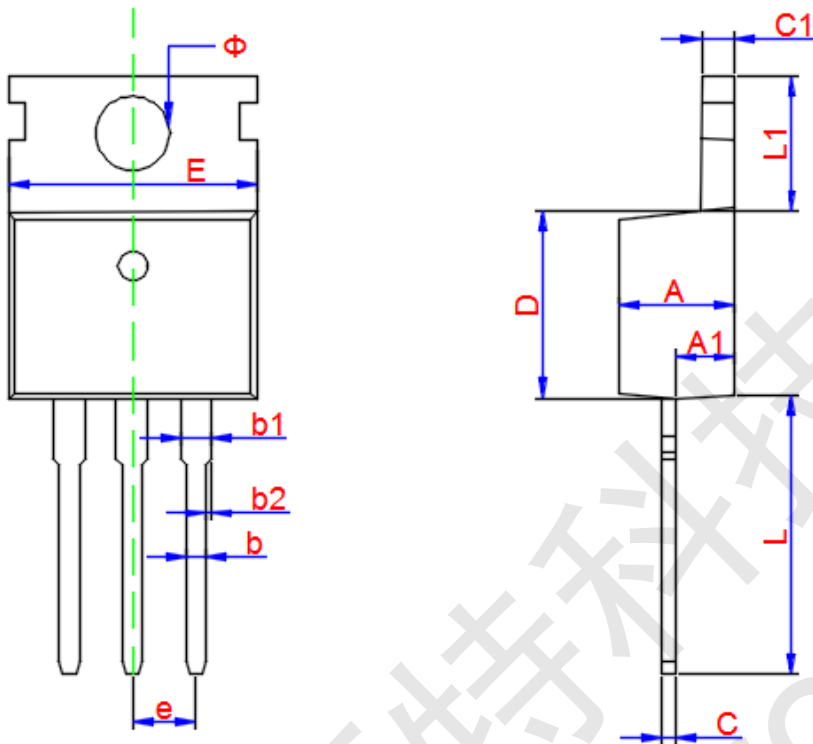

Figure 14 Normalized Maximum Transient Thermal Impedance



PE5N100Q TO-220 Package Information



Symbol	Dimensions In Millimeters		
	Min.	Typ.	Max.
A	4.520	4.570	4.620
A1	2.320	2.350	3.380
b	0.800 TYP.		
b1	1.270 TYP		
b2	0-0.076		
C	0.500 TYP.		
C1	1.300 TYP.		
D	9.050	9.100	9.150
E	9.880 TYP.		
e	2.540 TYP.		
L	13.160	13.260	13.360
L1	6.400	6.500	6.600
Φ	3.600 TYP.		