



### PE3N50K N-Channel Enhancement Mode Power MOSFET

#### PE3N50K Description

The PE3N50K uses advanced technology to provide excellent  $R_{DS(ON)}$  and low gate charge. It can be used in a wide variety of applications.

#### PE3N50K General Features

- $V_{DS}= 500V, I_D= 3A$

$$R_{DS(ON)} < 3\Omega @ V_{GS}=10V$$

- High Power and current handing capability
- Lead free product is acquired
- Surface Mount Package

#### PE3N50K Application

- Synchronous Rectification
- LED Power Supply
- DC/DC, AC/DC Converter

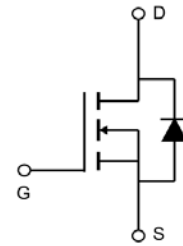

Schematic diagram

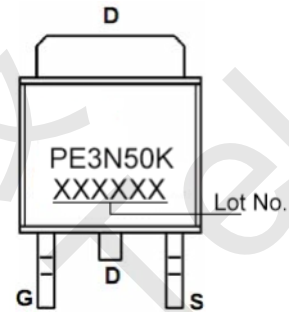

Marking and pin assignment

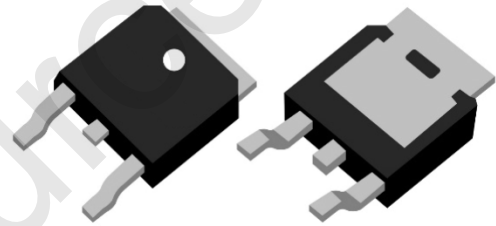

TO-252-2L

#### PE3N50K Absolute Maximum Ratings (TC=25°C unless otherwise noted)

Parameter	Symbol	Rating	Unit
Drain-Source Voltage	$V_{DS}$	500	V
Gate-Source Voltage	$V_{GS}$	±30	V
Drain Current-Continuous	$I_D$	3	A
Drain Current-Continuous (TC=100°C)	$I_D$	2	A
Pulsed Drain Current (Note 1)	$I_{DM}$	9	A
Maximum Power Dissipation	$P_D$	68	W
Single Pulsed Avalanche Energy (L=10.6mH)	$E_{AS}$	260	mJ
Operating Junction and Storage Temperature Range	$T_J, T_{STG}$	-55 To 175	°C

#### PE3N50K Thermal Characteristic

Thermal Resistance, Junction-to-Case	$R_{\theta JC}$	2.2	°C/W
Thermal Resistance, Junction-to-Ambient (Note 2)	$R_{\theta JA}$	55	°C/W



### PE3N50K Electrical Characteristics (TC=25°C unless otherwise noted)

Parameter	Symbol	Condition	Min	Typ	Max	Unit
<b>Off Characteristics</b>						
Drain-Source Breakdown Voltage	$BV_{DSS}$	$V_{GS}=0V, I_D=250\mu A$	500	-	-	V
Zero Gate Voltage Drain Current	$I_{DSS}$	$V_{DS}=500V, V_{GS}=0V$	-	-	1	$\mu A$
Gate-Body Leakage Current	$I_{GSS}$	$V_{GS}=\pm 30V, V_{DS}=0V$	-	-	$\pm 100$	nA
<b>On Characteristics</b> (Note 3)						
Gate Threshold Voltage	$V_{GS(th)}$	$V_{DS}=V_{GS}, I_D=250\mu A$	2	3	4	V
Drain-Source On-State Resistance	$R_{DS(ON)}$	$V_{GS}=10V, I_D=1.5A$	-	2.5	3	$\Omega$
Forward Transconductance	$g_{FS}$	$V_{DS}=40V, I_D=2.5A$	-	2.8	-	S
<b>Dynamic Characteristics</b> (Note 4)						
Input Capacitance	$C_{iss}$	$V_{DS}=25V, V_{GS}=0V,$ $F=1.0MHz$	-	355	-	pF
Output Capacitance	$C_{oss}$		-	10	-	pF
Reverse Transfer Capacitance (Note 4)	$C_{rss}$		-	2	-	pF
<b>Switching Characteristics</b>						
Turn-on Delay Time	$t_{d(on)}$	$V_{DS}=250V, I_D=3A,$ $V_{GS}=10V, R_G=25\Omega$	-	11	-	nS
Turn-on Rise Time	$t_r$		-	19	-	nS
Turn-Off Delay Time	$t_{d(off)}$		-	20.5	-	nS
Turn-Off Fall Time	$t_f$		-	15	-	nS
Total Gate Charge	$Q_g$	$V_{DS}=400V, I_D=3A,$ $V_{GS}=10V$	-	6.7	-	nC
Gate-Source Charge	$Q_{gs}$		-	1.7	-	nC
Gate-Drain Charge	$Q_{gd}$		-	2.7	-	nC
<b>Drain-Source Diode Characteristics</b>						
Diode Forward Voltage (Note 3)	$V_{SD}$	$V_{GS}=0V, I_S=3A$	-	-	1.2	V
Diode Forward Current (Note 2)	$I_S$		-	-	5	A
Body Diode Reverse Recovery Time	$t_{rr}$	$I_F=3A, di/dt=100A/\mu s$	-	134	-	nS
Body Diode Reverse Recovery Charge	$Q_{rr}$		-	0.89	-	$\mu C$

#### Notes:

1. Repetitive Rating: Pulse width limited by maximum junction temperature.
2. Surface Mounted on FR4 Board,  $t \leq 10$  sec.
3. Pulse Test: Pulse Width  $\leq 300\mu s$ , Duty Cycle  $\leq 2\%$ .
4. Guaranteed by design, not subject to product.



### PE3N50K Typical Electrical and Thermal Characteristics

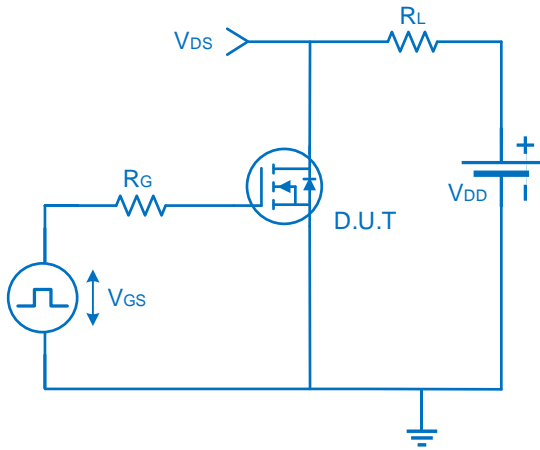

Figure 1 Switching Test Circuit

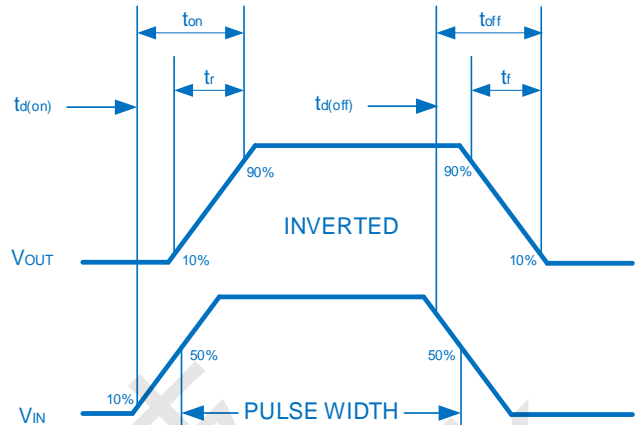

Figure 2 Switching Waveform

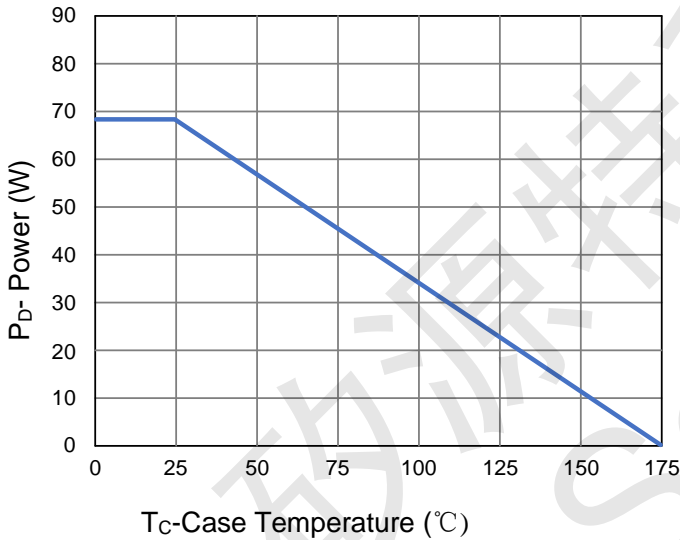

Figure 3 Power De-rating

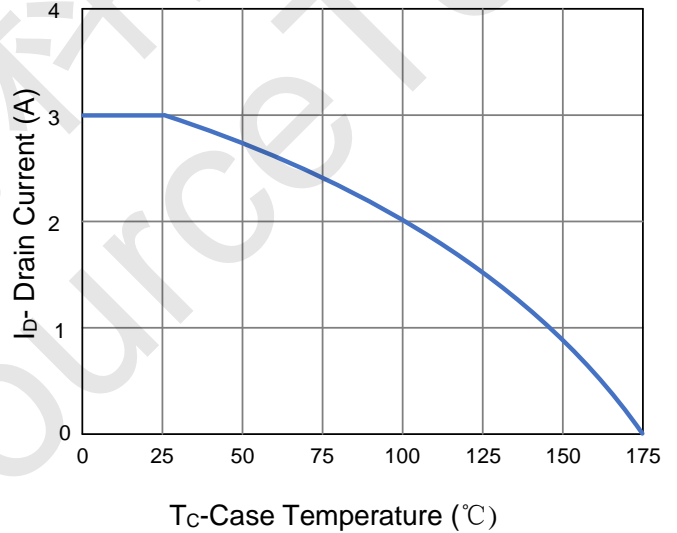

Figure 4 Drain Current

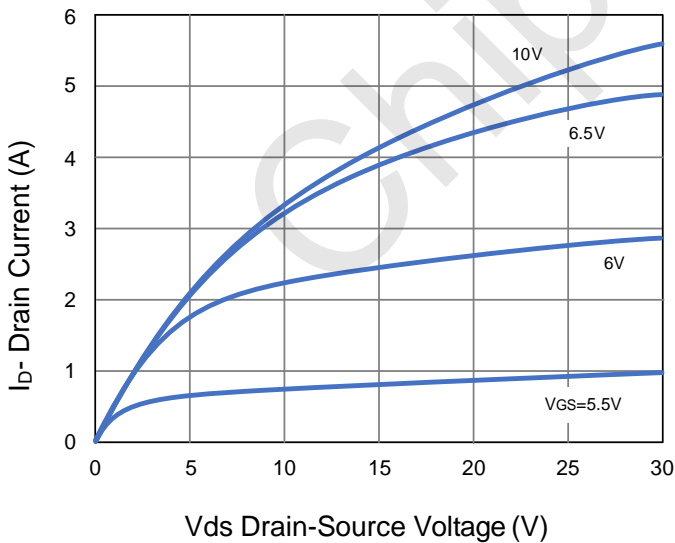

Figure 5 Output Characteristics

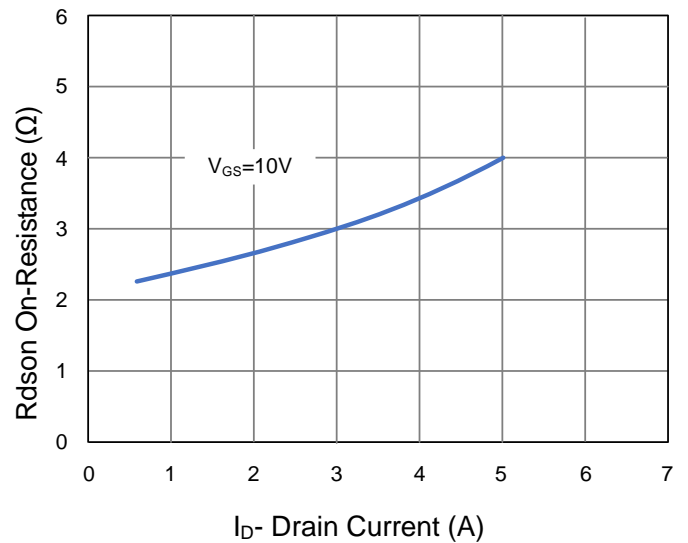

Figure 6 R<sub>dson</sub> vs Drain Current

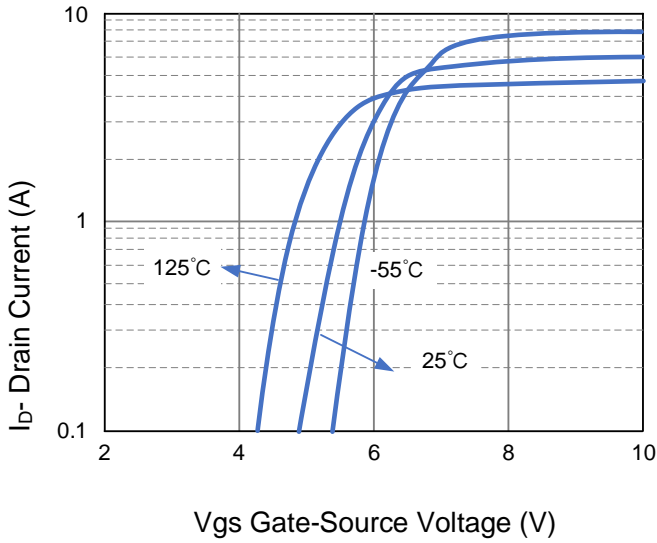

Figure 7 Transfer Characteristics

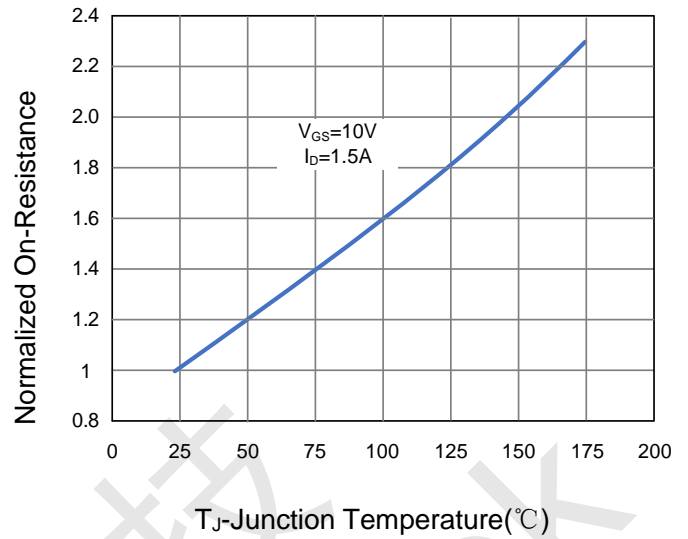

Figure 8  $R_{dson}$  vs Junction Temperature

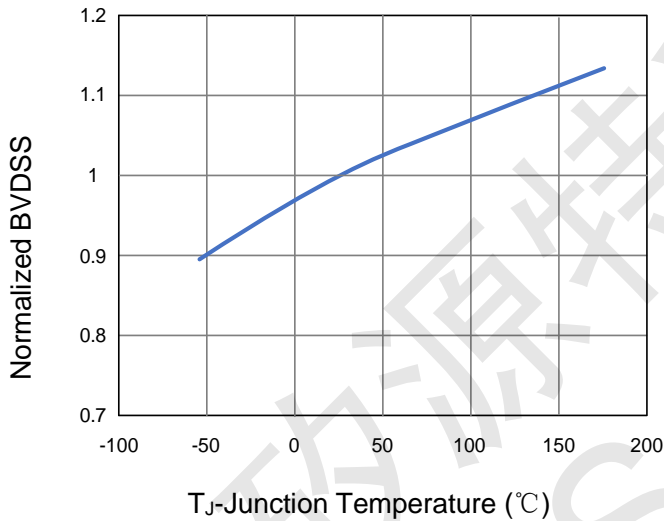

Figure 9  $B_{vdss}$  vs  $T_J$

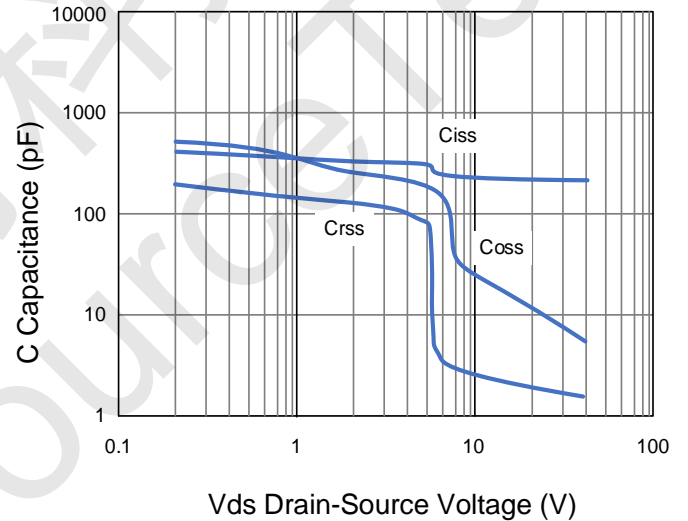

Figure 10 Capacitance vs  $V_{ds}$

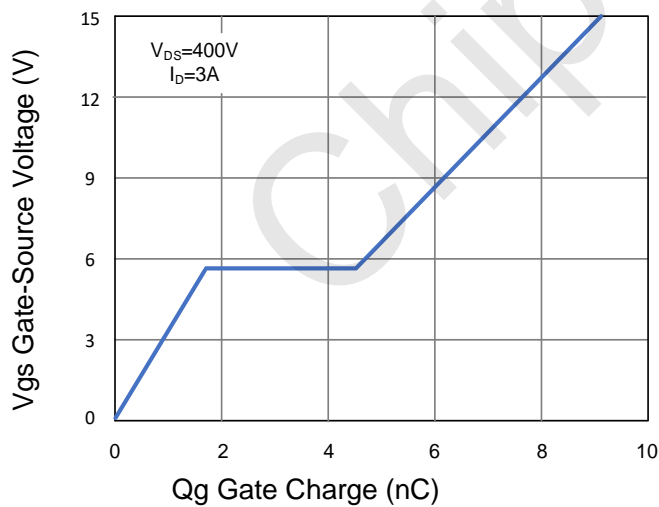

Figure 11 Gate Charge

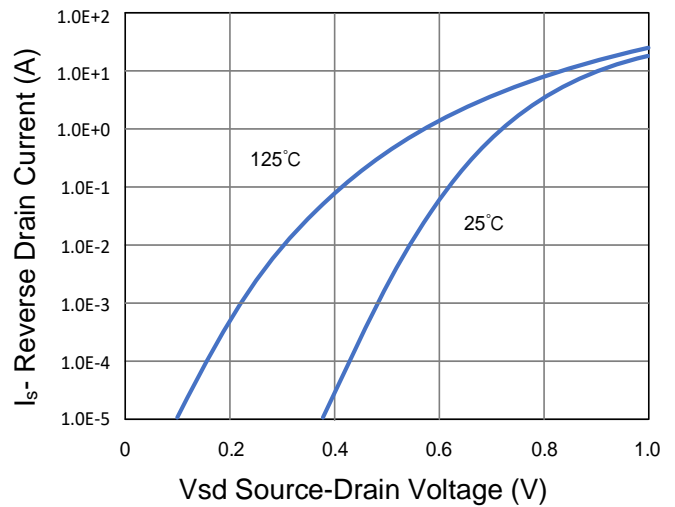

Figure 12 Source- Drain Diode Forward

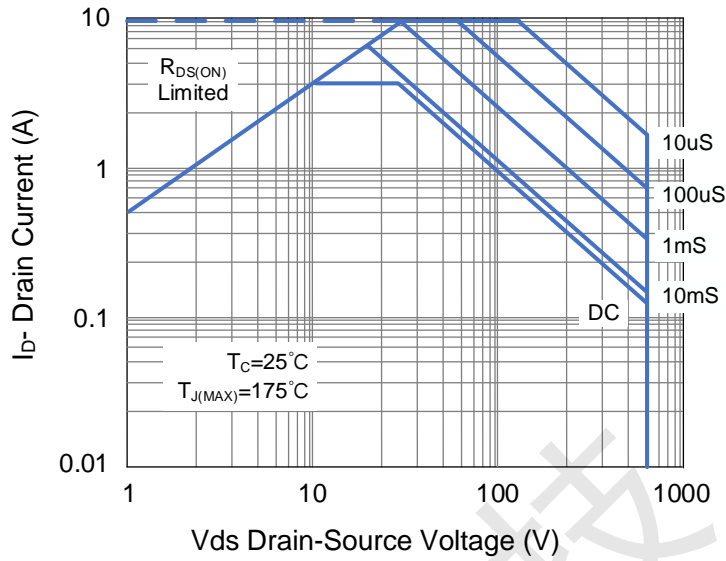

Figure 13 Safe Operation Area

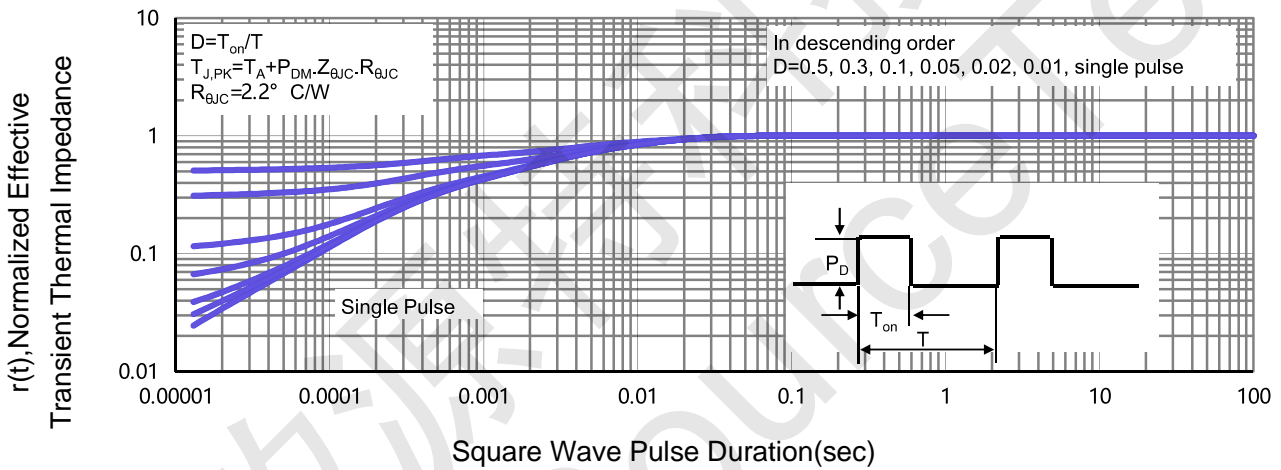
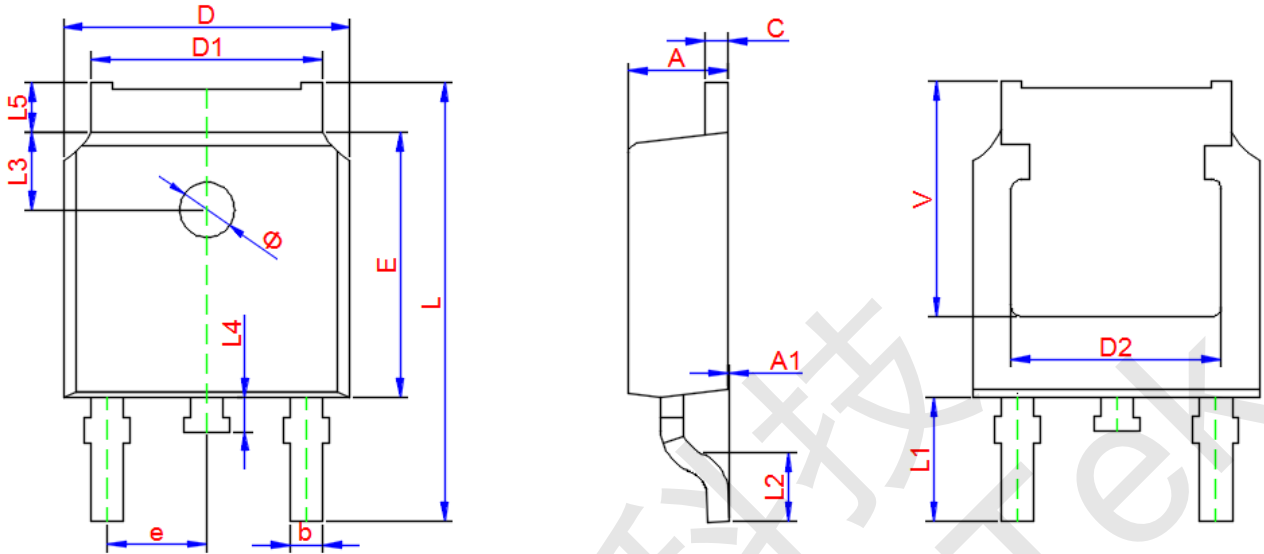

Figure 14 Normalized Maximum Transient Thermal Impedance



PE3N50K TO-252-2L Package Information



Symbol	Dimensions In Millimeters		
	Min.	Typ.	Max.
A	2.200	2.300	2.400
A1	0.000	--	0.127
b	0.660	0.760	0.860
D	6.500	6.600	6.700
D1	5.100	5.330	5.460
C	0.450	0.500	0.600
D2	4.830 TYP.		
E	6.000	6.100	6.200
e	2.186	2.286	2.386
L	9.800	10.100	10.400
L1	2.900 TYP.		
L2	1.400	1.500	1.600
L3	1.800 TYP.		
L4	0.600	0.800	1.000
L5	0.900	--	1.250
Φ	1.100.	--	1.300
V	5.350		