



PE01P40G P-Channel Enhancement Mode Power MOSFET

PE01P40G Description

The PE01P40G uses advanced trench technology to provide excellent $R_{DS(ON)}$ and low gate charge. It can be used in a wide variety of applications.

PE01P40G General Features

- $V_{DS} = -100V$, $I_D = -34A$
- $R_{DS(ON)} < 38m\Omega @ V_{GS}=-10V$
- $R_{DS(ON)} < 45m\Omega @ V_{GS}=-4.5V$
- High Power and current handling capability
- Lead free product is acquired
- Surface Mount Package

PE01P40G Application

- PWM applications
- Load switch
- Power management

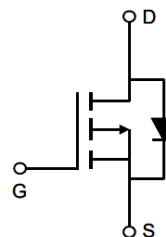

Schematic diagram

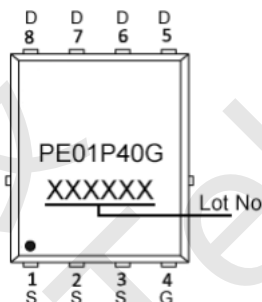

Marking and pin assignment

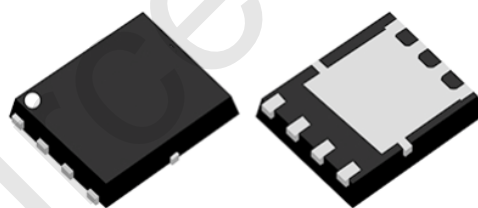

DFN5x6-8L

PE01P40G Absolute Maximum Ratings (TC=25°C unless otherwise noted)

Parameter	Symbol	Rating	Unit
Drain-Source Voltage	V_{DS}	-100	V
Gate-Source Voltage	V_{GS}	± 20	V
Drain Current-Continuous	I_D	-34	A
Drain Current-Continuous (TC=100°C)	I_D	-22	A
Pulsed Drain Current (Note 1)	I_{DM}	-136	A
Maximum Power Dissipation	P_D	96	W
Single Pulsed Avalanche Energy (L=0.1mH)	E_{AS}	218	mJ
Operating Junction and Storage Temperature Range	T_J, T_{STG}	-55 To 150	°C

PE01P40G Thermal Characteristic

Thermal Resistance, Junction-to-Case	$R_{\theta JC}$	1.3	°C/W
--------------------------------------	-----------------	-----	------



PE01P40G Electrical Characteristics (TC=25°C unless otherwise noted)

Parameter	Symbol	Condition	Min	Typ	Max	Unit
Off Characteristics						
Drain-Source Breakdown Voltage	BV_{DSS}	$V_{GS}=0V, I_D=-250\mu A$	-100	-	-	V
Zero Gate Voltage Drain Current	I_{DSS}	$V_{DS}=-90V, V_{GS}=0V$	-	-	-1	μA
Gate-Body Leakage Current	I_{GSS}	$V_{GS}=\pm 20V, V_{DS}=0V$	-	-	± 100	nA
On Characteristics (Note 3)						
Gate Threshold Voltage	$V_{GS(th)}$	$V_{DS}=V_{GS}, I_D=-250\mu A$	-1.2	-2	-2.5	V
Drain-Source On-State Resistance	$R_{DS(on)}$	$V_{GS}=-10V, I_D=-18A$	-	32	38	m Ω
		$V_{GS}=-4.5V, I_D=-10A$	-	36	45	m Ω
Dynamic Characteristics (Note 4)						
Input Capacitance	C_{iss}	$V_{DS}=-50V, V_{GS}=0V,$ $F=1.0MHz$	-	5612	-	pF
Output Capacitance	C_{oss}		-	180	-	pF
Reverse Transfer Capacitance (Note 4)	C_{rss}		-	80	-	pF
Gate Resistance	R_g	$V_{DS}=0V, V_{GS}=0V, F=1.0MHz$	-	4.3	-	Ω
Switching Characteristics						
Turn-on Delay Time	$t_{d(on)}$	$V_{DD}=-50V, I_D=-22A,$ $V_{GS}=-10V, R_G=3\Omega$	-	15	-	nS
Turn-on Rise Time	t_r		-	38	-	nS
Turn-Off Delay Time	$t_{d(off)}$		-	86	-	nS
Turn-Off Fall Time	t_f		-	68	-	nS
Total Gate Charge	Q_g	$V_{DS}=-50V, I_D=-22A,$ $V_{GS}=-10V$	-	102	-	nC
Gate-Source Charge	Q_{gs}		-	25	-	nC
Gate-Drain Charge	Q_{gd}		-	19	-	nC
Drain-Source Diode Characteristics						
Diode Forward Voltage (Note 3)	V_{SD}	$V_{GS}=0V, I_S=-1A$	-	-	-1.2	V
Maximum Body-Diode Current	I_S				-34	A
Body Diode Reverse Recovery Time	t_{rr}	$I_F=-18A, dI/dt=100A/\mu s$	-	36	-	nS
Body Diode Reverse Recovery Charge	Q_{rr}		-	62	-	nC

Notes:

1. Repetitive Rating: Pulse width limited by maximum junction temperature.
2. Surface Mounted on FR4 Board, $t \leq 10$ sec.
3. Pulse Test: Pulse Width $\leq 300\mu s$, Duty Cycle $\leq 2\%$.
4. Guaranteed by design, not subject to product.



PE01P40G Typical Electrical and Thermal Characteristics

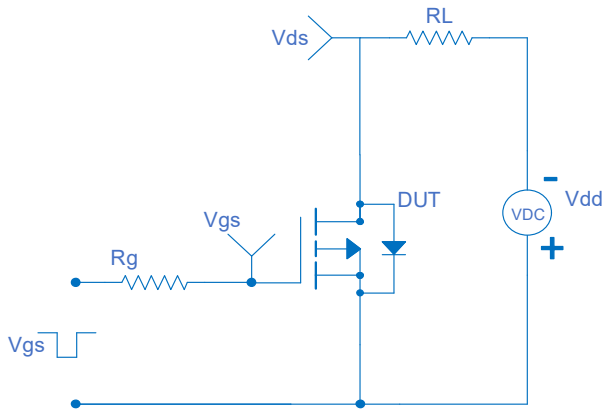

Figure 1 Switching Test Circuit

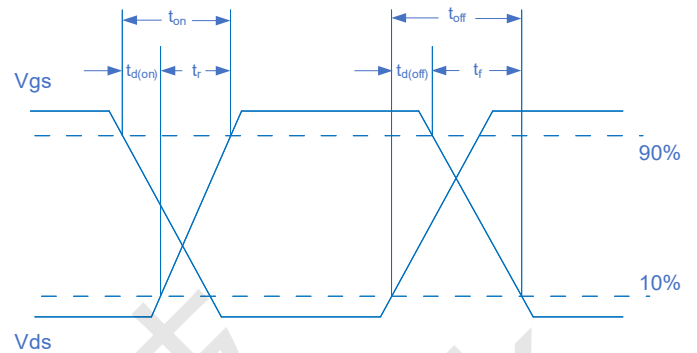

Figure 2 Switching Waveform

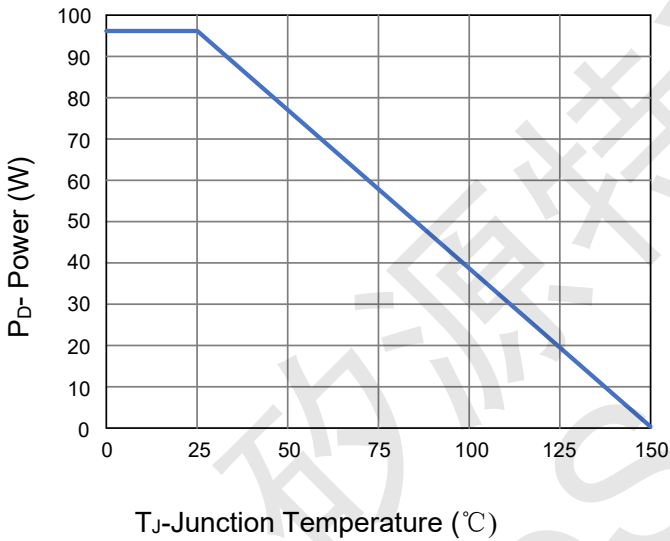

Figure 3 Power De-rating

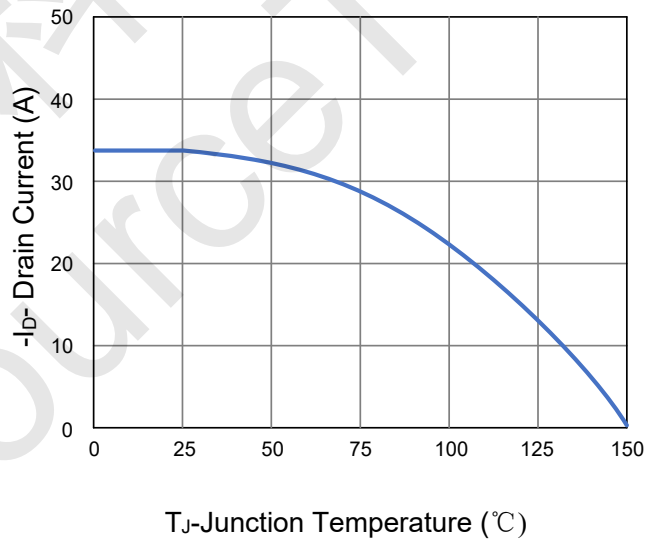

Figure 4 Drain Current

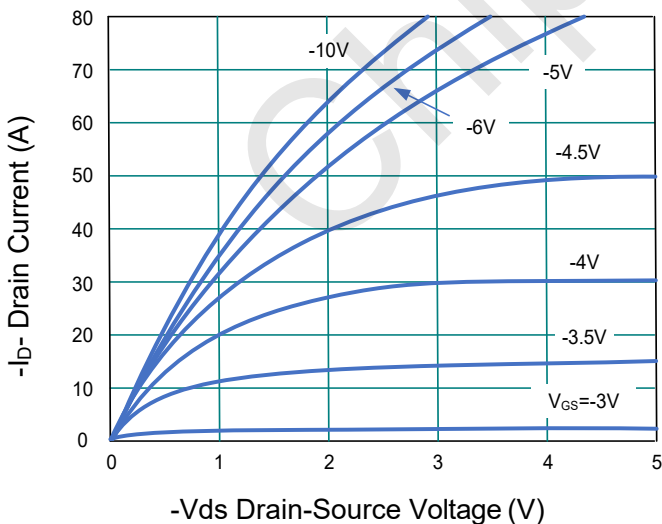

Figure 5 Output Characteristics

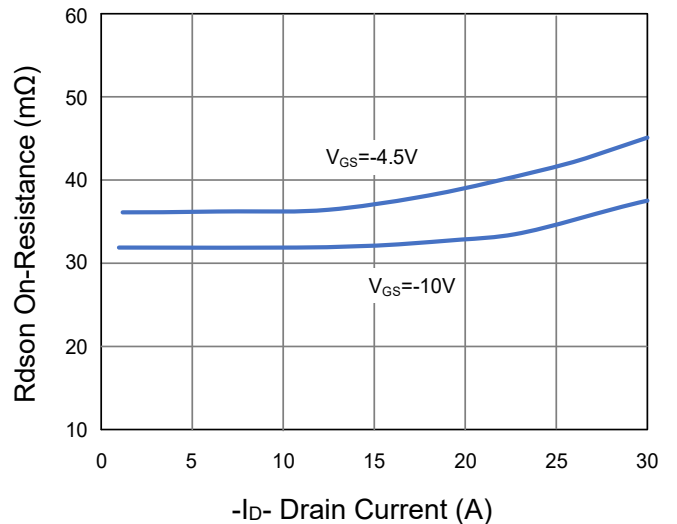

Figure 6 Rds(on) vs Drain Current

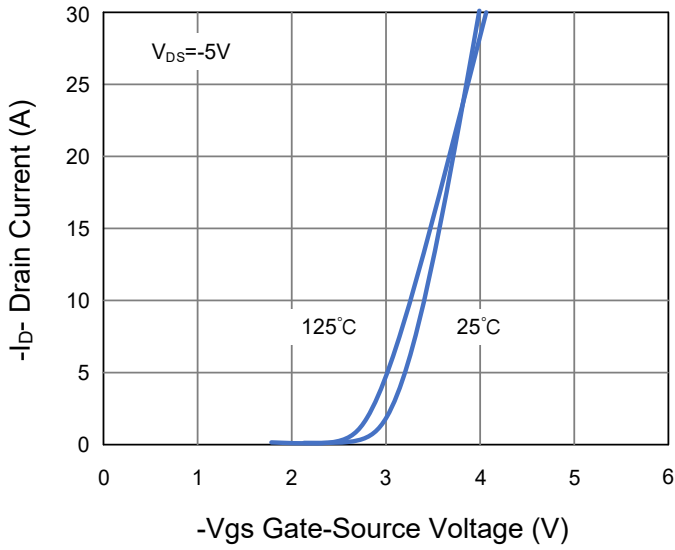

Figure 7 Transfer Characteristics

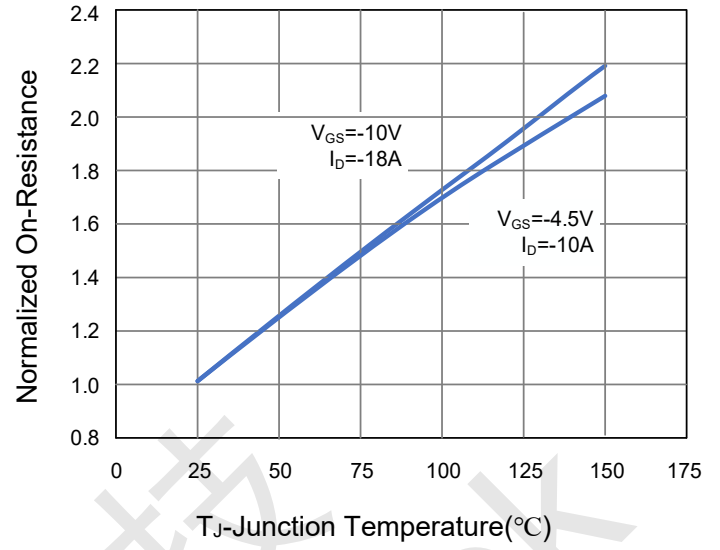

Figure 8 Rdson vs Junction Temperature

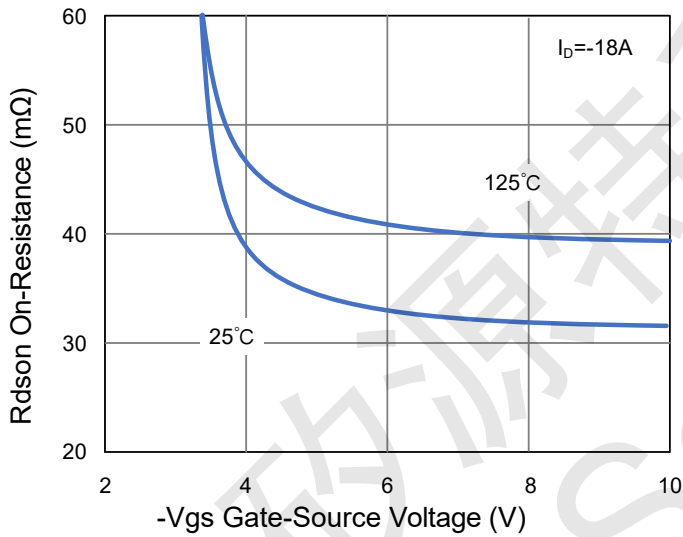

Figure 9 Rdson vs Vgs

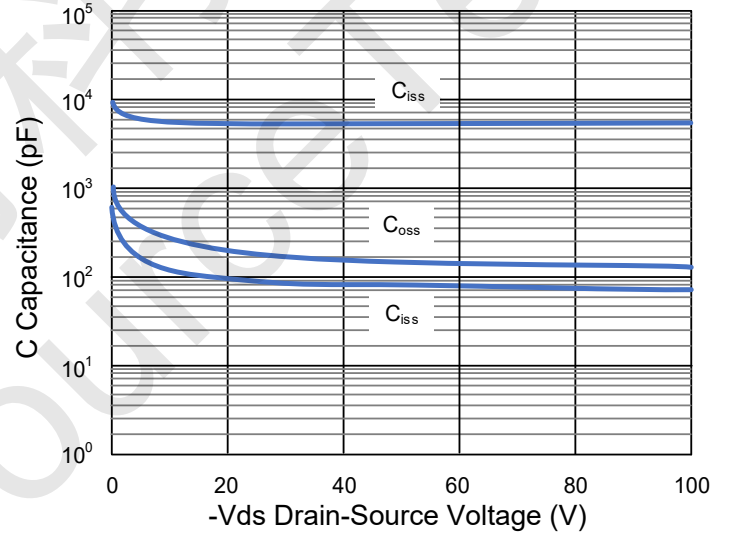

Figure 10 Capacitance vs Vds

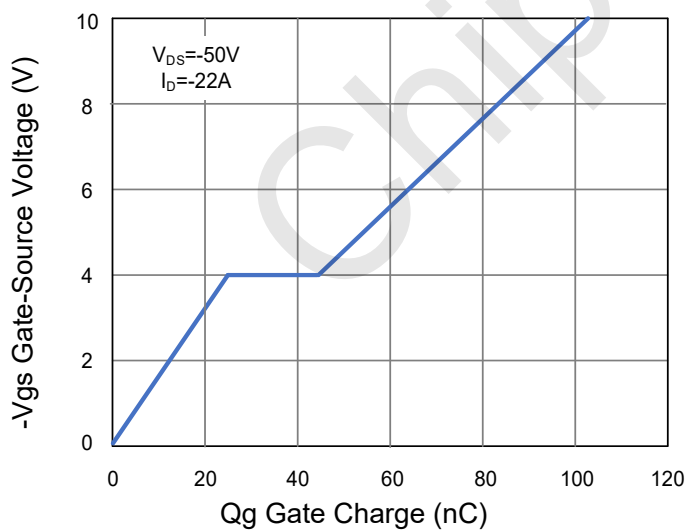

Figure 11 Gate Charge

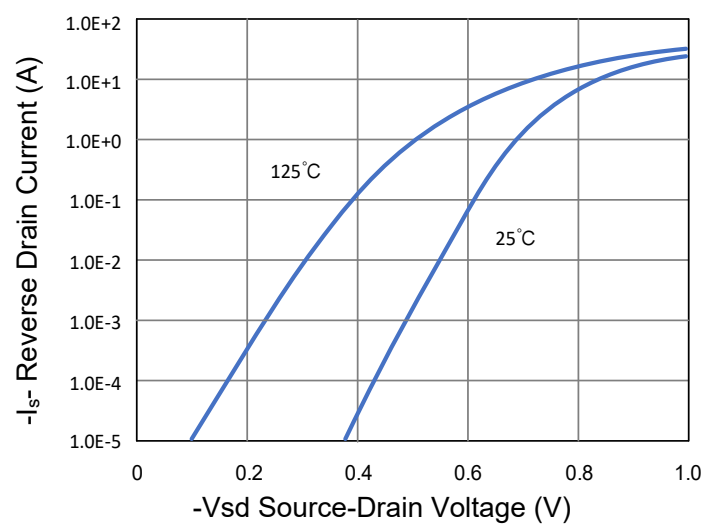

Figure 12 Source-Drain Diode Forward

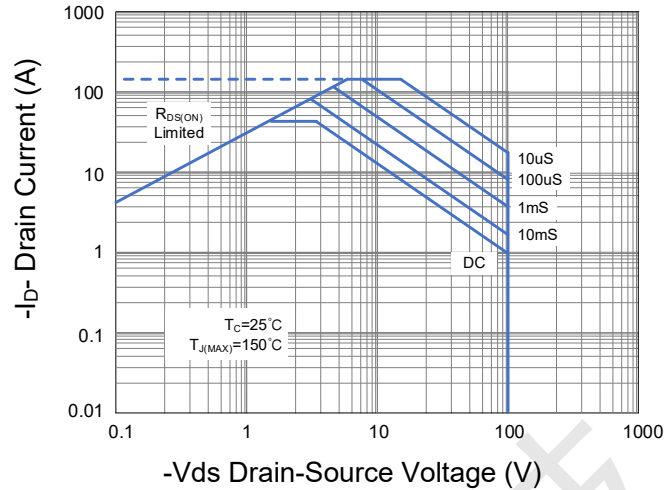

Figure 13 Safe Operation Area

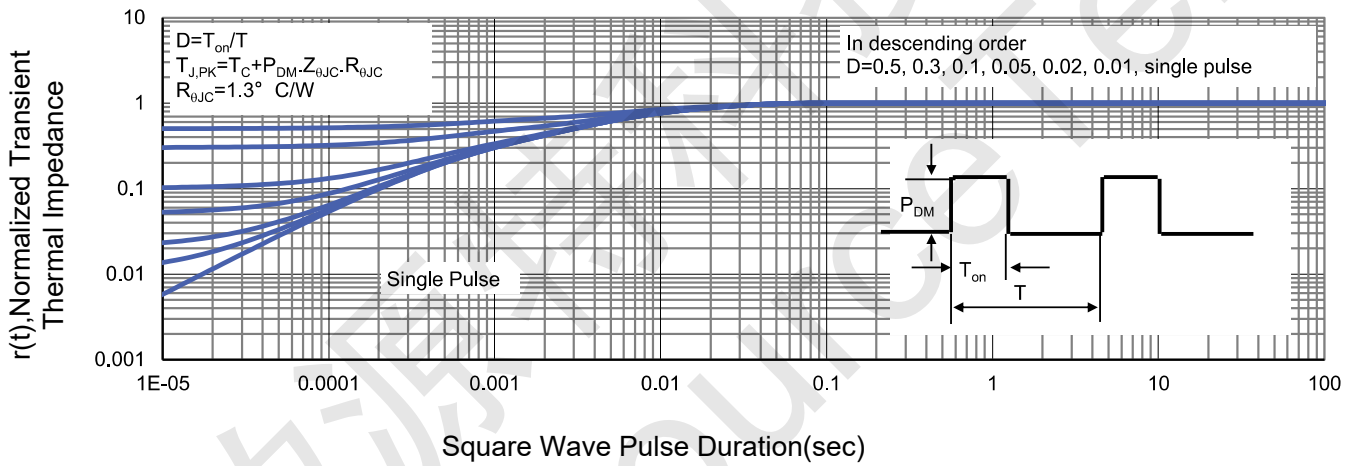
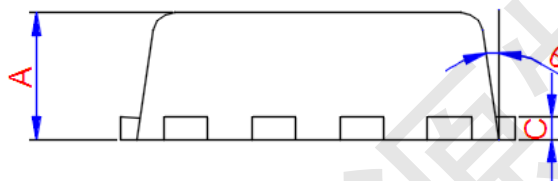
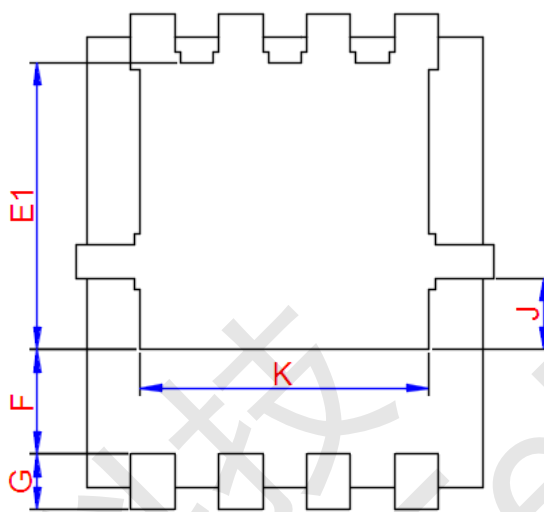
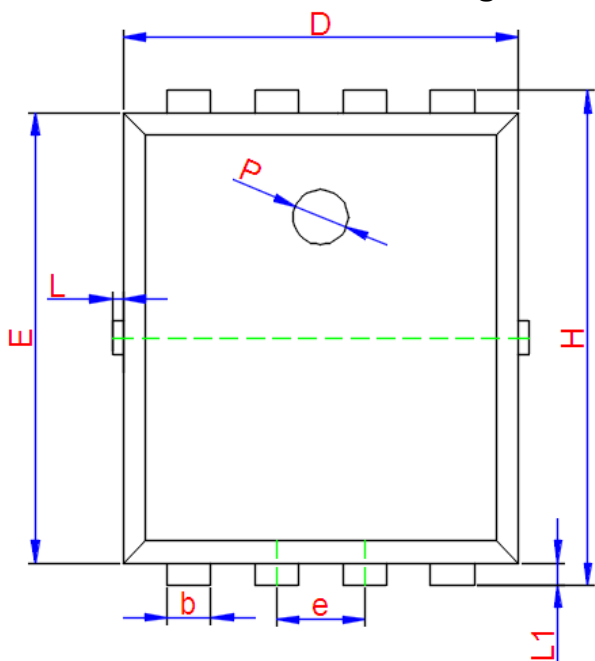

Figure 14 Normalized Maximum Transient Thermal Impedance



PE01P40G DFN5x6-8L Package Information



Symbol	Dimensions In Millimeters		
	Min.	Typ.	Max.
A	0.800	1.050	1.200
b	0.250	0.350	0.490
c	0.254TYP.		
D	4.800	5.000	5.100
e	1.270TYP.		
E	5.650	5.800	5.900
E1	3.400TYP.		
F	1.300TYP.		
G	0.600TYP.		
H	5.950	6.080	6.200
J	0.950TYP.		
K	4.000TYP.		
L	-	-	0.150
L1	0.100	0.140	0.180
P	1.180TYP.		
θ	6°	10°	14°