



Description

JMTK100N02A

JMT N-channel Enhancement Mode Power MOSFET

Features

- 20V, 30A
 $R_{DS(ON)} < 11.2m\Omega @ V_{GS} = 4.5V$
 $R_{DS(ON)} < 17.5m\Omega @ V_{GS} = 2.5V$
- Advanced Trench Technology
- Excellent $R_{DS(ON)}$ and Low Gate Charge
- Lead free product is acquired

Application

- Load Switch
- PWM Application
- Power management



100% UIS TESTED!
100% ΔV_{ds} TESTED!

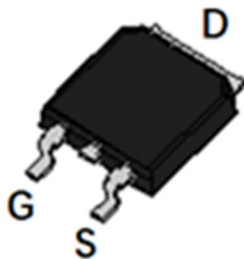

TO-252-4R(DPAK) top view



Marking and pin Assignment

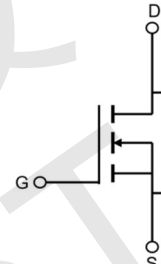

Schematic Diagram

Package Marking and Ordering Information

Device Marking	Device	OUTLINE	Device Package	Reel Size	Reel (PCS)	Per Carton (PCS)
JMTK100N02A	JMTK100N02A	TAPING	TO-252-4R	13inch	2500	25000

Absolute Maximum Ratings (T_C=25°C unless otherwise specified)

Symbol	Parameter	Max.	Units
V _{DSS}	Drain-Source Voltage	20	V
V _{GSS}	Gate-Source Voltage	±12	V
I _D	Continuous Drain Current	T _C = 25°C	30 A
		T _C = 100°C	20 A
I _{DM}	Pulsed Drain Current ^{note1}	120	A
E _{AS}	Single Pulsed Avalanche Energy ^{note2}	23	mJ
P _D	Power Dissipation	20	W
R _{θJC}	Thermal Resistance, Junction to Case	7.5	°C/W
T _J , T _{STG}	Operating and Storage Temperature Range	-55 to +175	°C



JMTK100N02A

Electrical Characteristics (T_J=25°C unless otherwise specified)

Symbol	Parameter	Test Condition	Min.	Typ.	Max.	Units
Off Characteristic						
V _{(BR)DSS}	Drain-Source Breakdown Voltage	V _{GS} =0V, I _D =250μA	20	-	-	V
I _{DSS}	Zero Gate Voltage Drain Current	V _{DS} =20V, V _{GS} =0V,	-	-	1.0	μA
I _{GSS}	Gate to Body Leakage Current	V _{DS} =0V, V _{GS} =±12V	-	-	±100	nA
On Characteristics						
V _{GS(th)}	Gate Threshold Voltage	V _{DS} =V _{GS} , I _D =250μA	0.5	0.75	1.2	V
R _{DS(on)}	Static Drain-Source on-Resistance <small>note3</small>	V _{GS} =4.5V, I _D =15A	-	8	11.2	mΩ
		V _{GS} =2.5V, I _D =10A	-	11.7	17.5	
Dynamic Characteristics						
C _{iss}	Input Capacitance	V _{DS} =10V, V _{GS} =0V, f=1.0MHz	-	1000	-	pF
C _{oss}	Output Capacitance		-	182	-	pF
C _{rss}	Reverse Transfer Capacitance		-	164	-	pF
Q _g	Total Gate Charge	V _{DS} =10V, I _D =15A, V _{GS} =4.5V	-	15	-	nC
Q _{gs}	Gate-Source Charge		-	2	-	nC
Q _{gd}	Gate-Drain("Miller") Charge		-	5.2	-	nC
Switching Characteristics						
t _{d(on)}	Turn-on Delay Time	V _{DS} =10V, I _D =15A, R _{GEN} =3Ω, V _{GS} =4.5V	-	9	-	ns
t _r	Turn-on Rise Time		-	25	-	ns
t _{d(off)}	Turn-off Delay Time		-	37	-	ns
t _f	Turn-off Fall Time		-	14	-	ns
Drain-Source Diode Characteristics and Maximum Ratings						
I _S	Maximum Continuous Drain to Source Diode Forward Current		-	-	30	A
I _{SM}	Maximum Pulsed Drain to Source Diode Forward Current		-	-	120	A
V _{SD}	Drain to Source Diode Forward Voltage	V _{GS} =0V, I _S =30A	-	-	1.2	V

- Notes: 1. Repetitive Rating: Pulse Width Limited by Maximum Junction Temperature
 2. EAS condition: T_J=25°C, V_{DD}=10V, V_G=4.5V, L=0.5mH, R_G=25Ω, I_{AS}=9.6A
 3. Pulse Test: Pulse Width≤300μs, Duty Cycle≤0.5%



JMTK100N02A

Typical Performance Characteristics

Figure 1: Output Characteristics

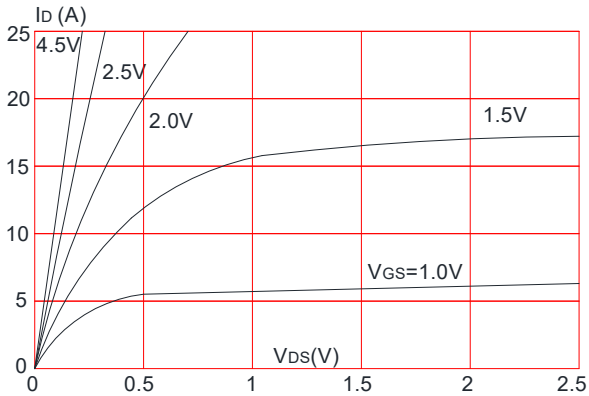

Figure 2: Typical Transfer Characteristics

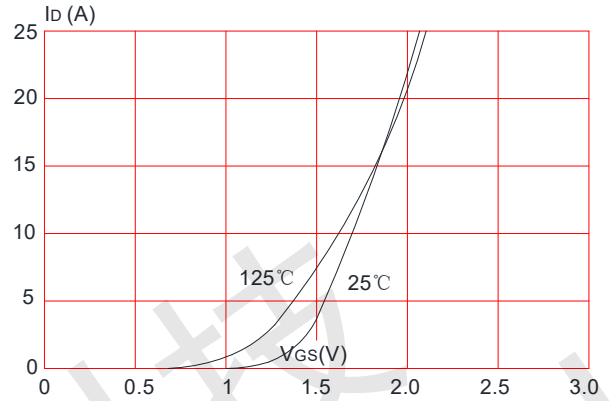

Figure 3: On-resistance vs. Drain Current

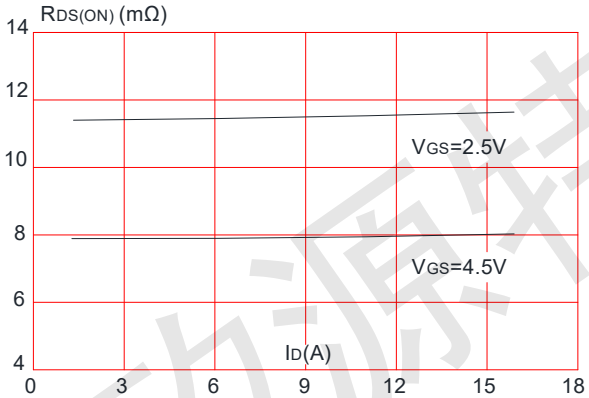

Figure 4: Body Diode Characteristics

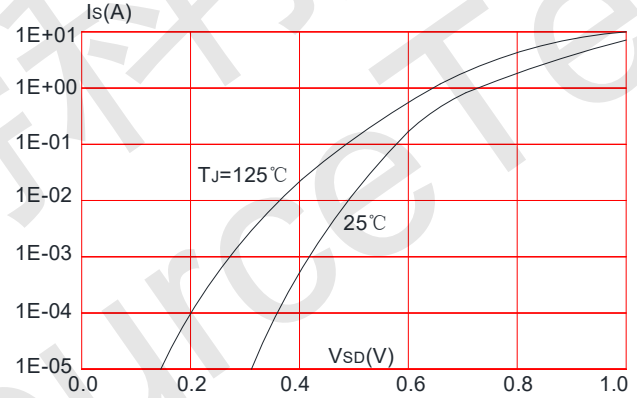

Figure 5: Gate Charge Characteristics

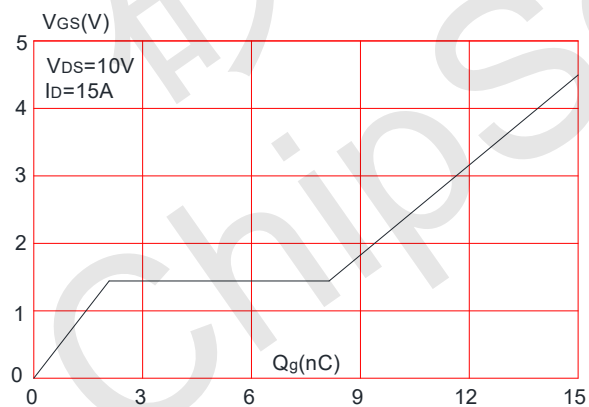
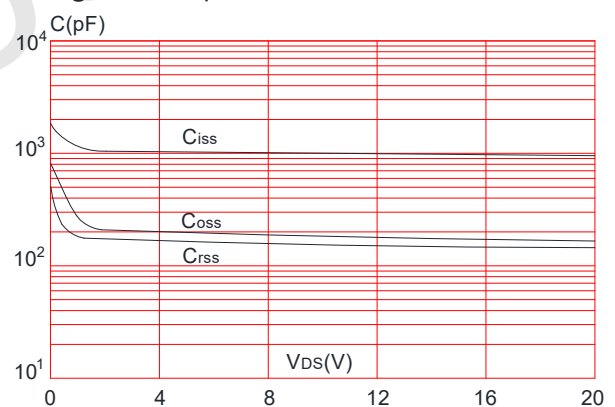

Figure 6: Capacitance Characteristics





JMTK100N02A

Figure 7: Normalized Breakdown Voltage vs. Junction Temperature

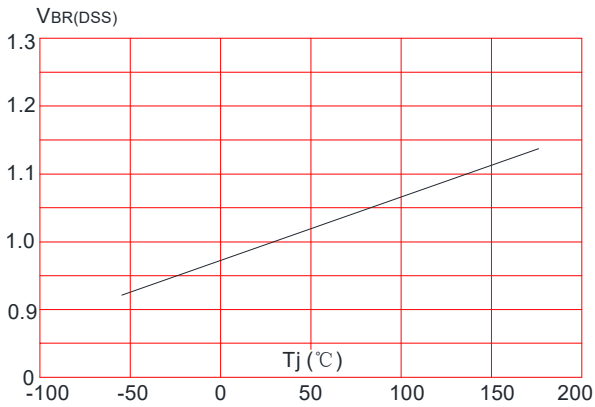

Figure 8: Normalized on Resistance vs. Junction Temperature

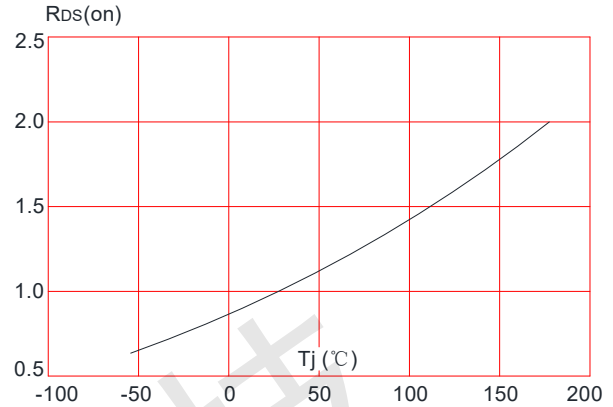

Figure 9: Maximum Safe Operating Area

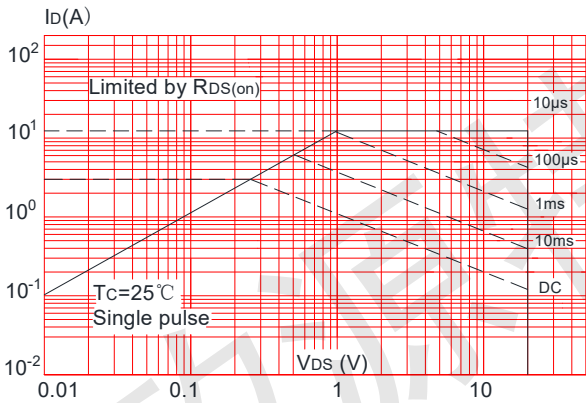

Figure 10: Maximum Continuous Drain Current vs. Case Temperature

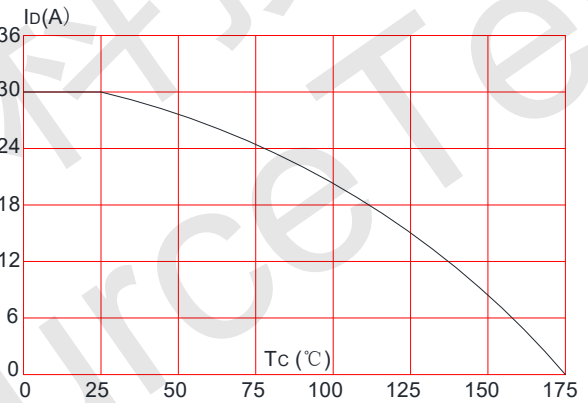
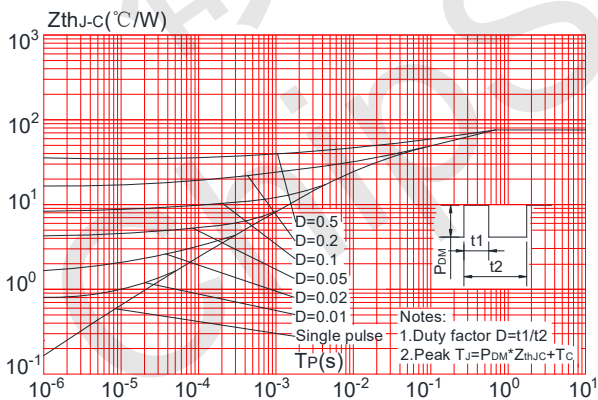

Figure 11: Maximum Effective Transient Thermal Impedance, Junction-to-Case





JMTK100N02A

Test Circuit

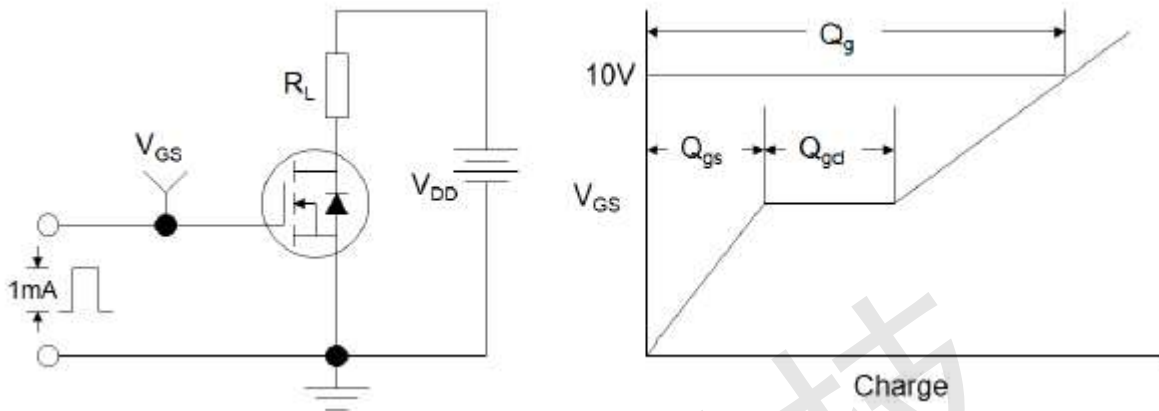

Figure1:Gate Charge Test Circuit & Waveform

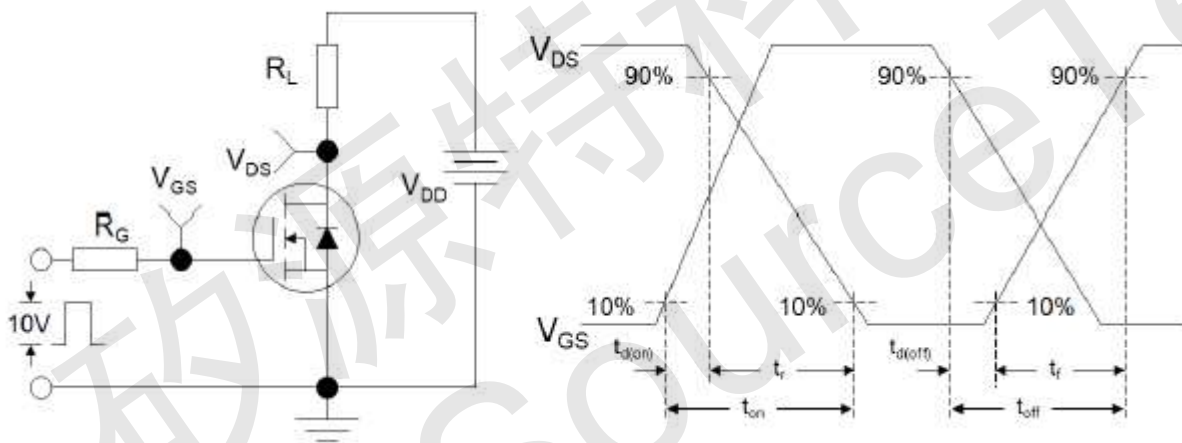

Figure 2: Resistive Switching Test Circuit & Waveforms

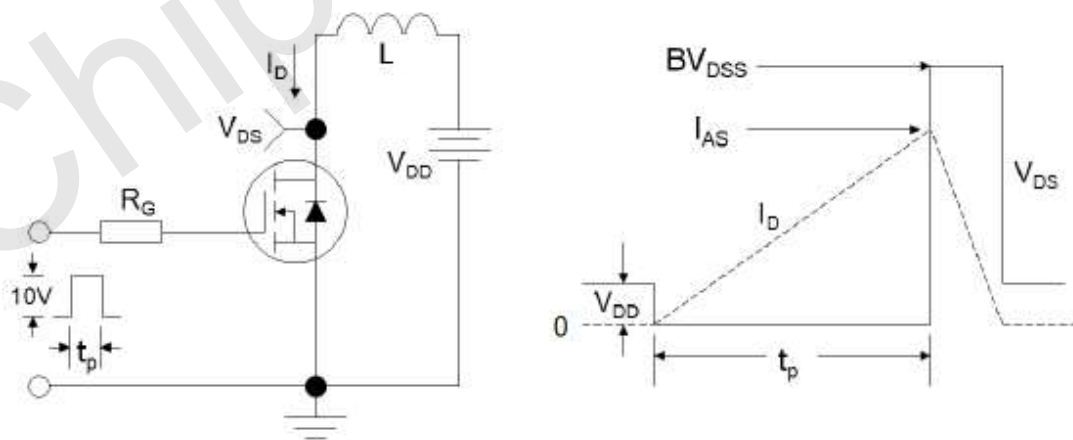
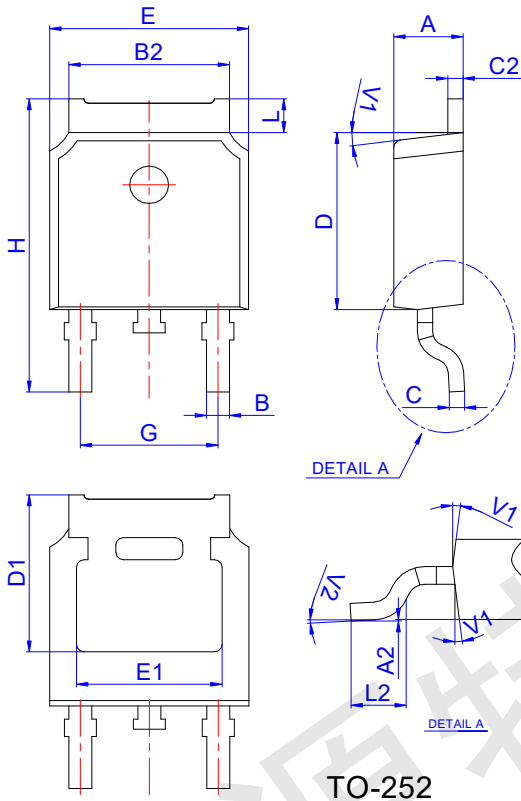

Figure 3:Unclamped Inductive Switching Test Circuit & Waveforms



JMTK100N02A



	2.10	2.50	0.083		0.098
	0	0.10	0		0.004
	0.66	0.86	0.026		0.034
B2	5.18	5.48	0.202		0.216
C	0.40	0.60	0.016		0.024
C2	0.44	0.58	0.017		0.023
D	5.90	6.30	0.232		0.248
D1	5.30REF		0.209REF		
E	6.40	6.80	0.252		0.268
E1	4.63		0.182		
G	4.47	4.67	0.176		0.184
H	9.50	10.70	0.374		0.421
L	1.09	1.21	0.043		0.048
L2	1.35	1.65	0.053		0.065
V1		7°		7°	
V2	0°	6°	0°		6°

Reel Specification-TO-252-4R

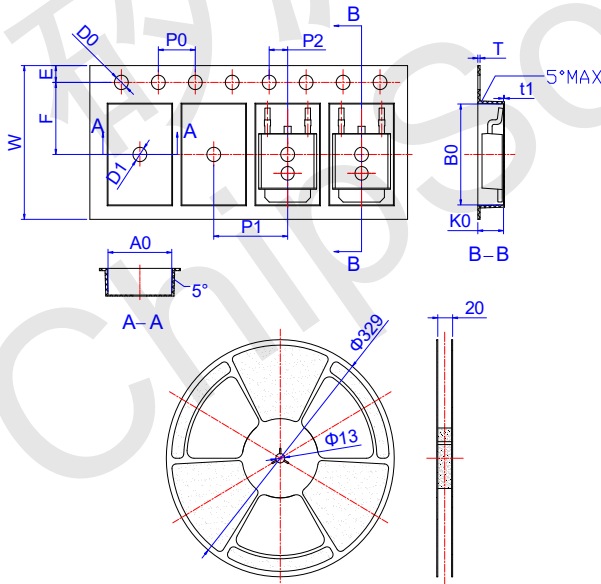

Ref.	Dimensions					
	Millimeters			Inches		
	Min.	Typ.	Max.	Min.	Typ.	Max.
W	15.90	16.00	16.10	0.626	0.630	0.634
E	1.65	1.75	1.85	0.065	0.069	0.073
F	7.40	7.50	7.60	0.291	0.295	0.299
D0	1.40	1.50	1.60	0.055	0.059	0.063
D1	1.40	1.50	1.60	0.055	0.059	0.063
P0	3.90	4.00	4.10	0.154	0.157	0.161
P1	7.90	8.00	8.10	0.311	0.315	0.319
P2	1.90	2.00	2.10	0.075	0.079	0.083
A0	6.85	6.90	7.00	0.270	0.271	0.276
B0	10.45	10.50	10.60	0.411	0.413	0.417
K0	2.68	2.78	2.88	0.105	0.109	0.113
T	0.24		0.27	0.009		0.011
t1	0.10			0.004		
10P0	39.80	40.00	40.20	1.567	1.575	1.583