



## 内置高效率自适应电荷泵升压，防削顶失真功能，D/AB切换的 5.5W单声道高保真音频功率放大器

### ■ HT8313特点

- 防削顶失真功能(Anti-Clipping Function, ACF)
- 自适应电荷泵升压功能
- 内部固定28dB增益
- 输出功率(Class D)
  - 5.5W ( $V_{BAT}=4.2V$ ,  $R_L=4\Omega+22\mu H$ ,  $THD+N=10\%$ )
  - 4.5W ( $V_{BAT}=4.2V$ ,  $R_L=4\Omega+22\mu H$ ,  $THD+N=1\%$ )
- 输出功率(Class AB)
  - 2.8W ( $V_{BAT}=5V$ ,  $R_L=4\Omega$ ,  $THD+N=10\%$ )
  - 2.3W ( $V_{BAT}=5V$ ,  $R_L=4\Omega$ ,  $THD+N=1\%$ )
- 电源
  - 升压输入 $V_{BAT}$ : 2.7V至5.5V
  - 升压输出PVDD: 6.6V
- 静态工作电流: 3mA
- 关断电流: <1uA
- AB/D类可切换
- 免滤波器数字调制，直接驱动扬声器
- 保护功能:过流/过热/欠压异常保护功能
- 无铅封装，SOP10L-PP

### ■ HT8313应用

- 智能音响
- 无线音响
- 便携式音频设备
- 智能手机

### ■ HT8313典型应用图

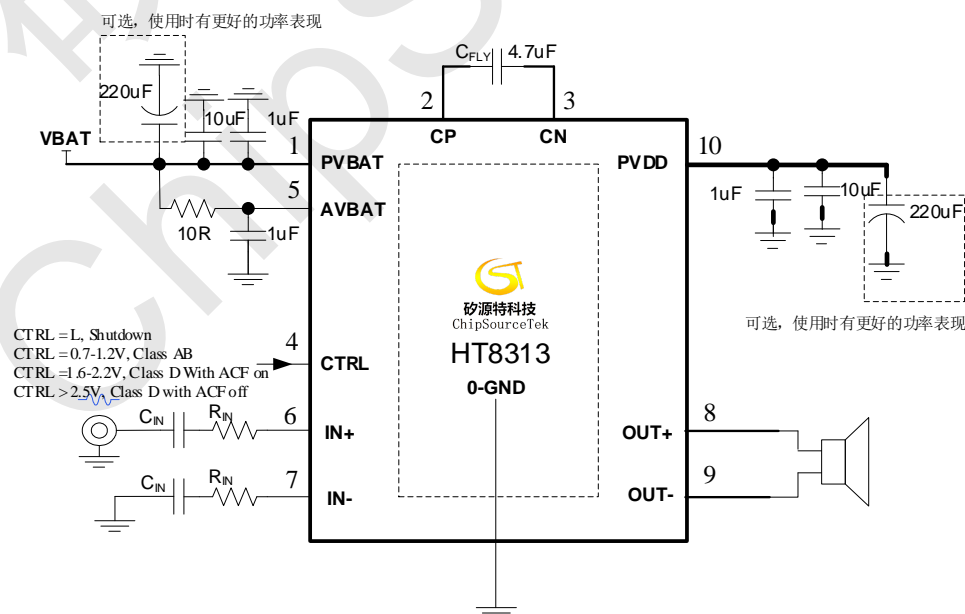

### ■ HT8313概述

HT8313是一款D类音频功率放大器，在 $V_{BAT}=5V$ 、 $THD+N=10\%$ ， $4\Omega$ 负载条件下能连续输出5.5W功率。该D类功放的电源电压由内置的自适应电荷泵升压模块提供。该升压模块在低功率时不升压，可有效提升电池的播放时间。

HT8313的最大特点是防削顶失真（ACF）输出控制功能，可检测并抑制由于输入音乐、语音信号幅度过大所引起的输出信号削顶失真（破音），也能自适应地防止在升压电压下降所造成的输出削顶，显著提高音质，创造非常舒适的听音享受，并保护扬声器免受过载损坏。

HT8313具有AB类和D类的自由切换功能，在受到D类功放EMI干扰困扰时，可随时切换至AB类音频功放模式（此时电荷泵升压功能关闭）。

HT8313内部集成免滤波器数字调制技术，能够直接驱动扬声器，并最大程度减小脉冲输出信号的失真和噪音。输出无需滤波网络，极少的外部元器件节省了系统空间和成本，是便携式应用的理想选择。

此外，HT8313内部固定28dB增益，内置的关断功能使待机电流最小化，还集成了输出端过流保护、片内过温保护和电源欠压异常保护等功能。



## 5.5W Anti-Clipping Mono Class D/AB Audio Amplifier with Adaptive Charge Pump Regulator

### HT8313 FEATURE

- Anti-Clipping Function (ACF)
- Adaptive Charge Pump Regulator
- Maximum Voltage Gain: 28dB
- Output Power (Class D)
  - 5.5W ( $V_{BAT}=5V$ ,  $R_L=4\Omega$ , THD+N=10%)
  - 4.5W ( $V_{BAT}=5V$ ,  $R_L=4\Omega$ , THD+N=1%)
- Output Power (Class AB)
  - 2.8W ( $V_{BAT}=5V$ ,  $R_L=4\Omega$ , THD+N=10%)
  - 2.3W ( $V_{BAT}=5V$ ,  $R_L=4\Omega$ , THD+N=1%)
- Power Supply
  - Input  $V_{BAT}$ : 2.7V to 5.5V
  - Output PVDD: 6.6V
- Quiescent Current: 3mA
- Shutdown Current: <1uA
- Class AB / Class D selectable
- Filter-less Modulation, Eliminating Output Filter
- Over Current Protection, Thermal Protection, Low voltage malfunction prevention function included
- Pb-Free Packages , SOP10L-PP

### HT8313 APPLICATIONS

- Smart Speakers      • Wireless Speakers
- Portable Audio Devices      • Smart Phones

### HT8313 TYPICAL APPLICATION

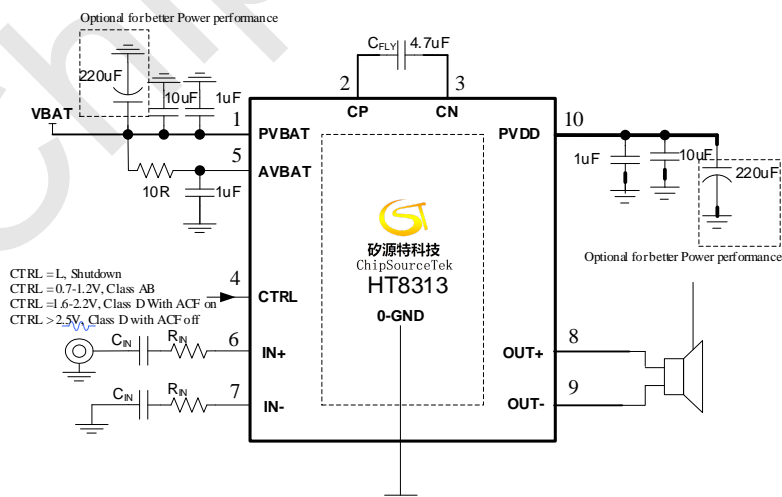

### HT8313 GENERAL DESCRIPTION

HT8313 is a Class D audio amplifier which can deliver continuous 5.5W output power into a 4Ω speaker with 5V power supply when THD+N = 10%. The class D audio amplifier's power supply is adaptively boosted by the integrated charge pump regulator which only works while the output power is big enough. This will significantly extend the playing time in battery supply applications.

HT8313 features Anti-Clipping Function (ACF) which detects output signal clip due to the over input signal and suppresses the output signal clip automatically. Also, it can adapt the output clip caused by power supply voltage down. It can significantly improve the sound quality, creating a very comfortable musical enjoyment, and to protect the speakers from overload damage.

Class AB amplifier mode is also available for HT8313. Once the EMI Interference from class D and Boost Converter becomes an annoying problem, HT8313 can be changed into Class AB mode.

HT8313 has a filter-less modulation circuit which directly drives speakers while realizes low distortion and low noise characteristics. Thanks to filter-less, circuit design with fewer external parts can be made in portable applications.

HT8313 has an internal gain of 28dB and an independent Shutdown function which can minimize the power consumption. As for protection function, over current protection function for speaker output terminals, over temperature protection function, and low supply voltage malfunction preventing function are also prepared.



## ■ HT8313 TERMINAL CONFIGURATION



SPE (ESSOP10) Top View

## ■ HT8313 TERMINAL FUNCTION<sup>1</sup>

Terminal No.	Name	I/O	ESD Protection	Description
0	GND	GND	--	Ground
1	PVBAT	POWER	PN	Power supply for the charge pump regulator
2	CP	I	PN	Flying capacitor positive terminal
3	CN	I	PN	Flying capacitor negative terminal
4	CTRL	I	PN	Mode selection terminal. When it is pulled low, the device goes into shutdown mode.
5	AVBAT	POWER	PN	Analog power supply
6	IN+	I	PN	Positive audio input terminal
7	IN-	I	PN	Negative audio input terminal
8	OUT+	O	PN	Positive BTL audio output
9	OUT-	O	PN	Negative BTL audio output
10	PVDD	POWER	PN	Power supply for audio amplifier



■ HT8313 ORDERING INFORMATION

Part Number	Package Type	Marking	Operating Temperature Range	Shipping Package / MOQ
HT8313SPET	ESSOP10 (SPE)	HT8313 YYYMAAB <sup>2</sup>	-40℃~85℃	Tape and Reel (R) / 2500pcs
HT8313SPER	ESSOP10 (SPE)	HT8313 YYYMAAB	-40℃~85℃	Tube (T) / 100pcs

Part Number

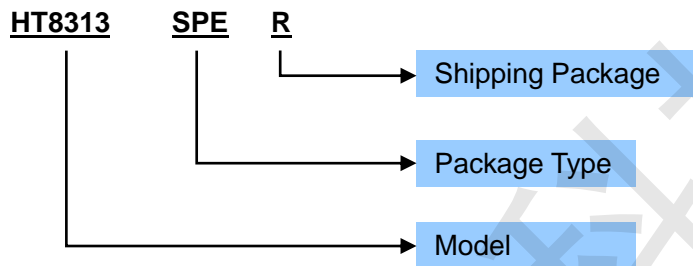

Production Tracking Code

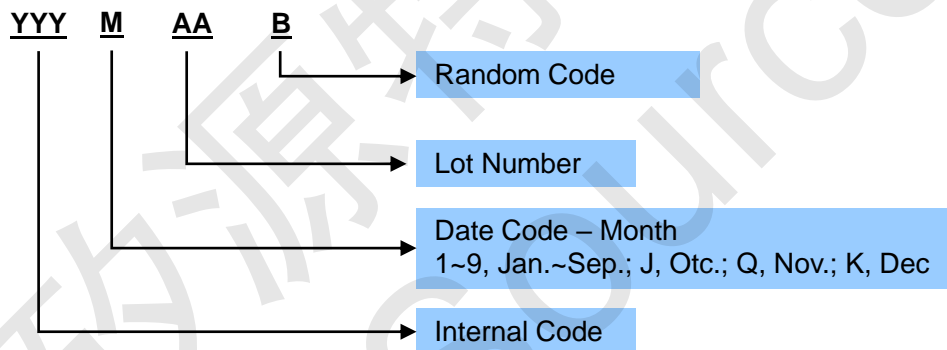



● HT8313 ELECTRICAL CHARACTERISTICS<sup>3</sup>

● Absolute Maximum Ratings<sup>4</sup>

PARAMETER	SYMBOL	MIN	MAX	UNIT
Supply voltage range (PVBAT, AVBAT)	VBAT	-0.3	7	V
Input voltage range (IN+, IN-)	V <sub>IN</sub>	-0.6	AVBAT+0.6	V
Operating temperature range	T <sub>A</sub>	-40	85	°C
Operating junction temperature range	T <sub>J</sub>	-40	150	°C
Storage temperature range	T <sub>STG</sub>	-50	150	°C

● Recommended Operating Conditions

PARAMETER	SYMBOL	CONDITION	MIN	TYP	MAX	UNIT
Supply voltage range (PVBAT, AVBAT)	VBAT		2.7	2.7	5.5	V
Operating temperature range	T <sub>a</sub>		-40	25	85	°C
Speaker resistance	R <sub>L</sub>			4		Ω

● Electrical Specifications

**General Specifications**

Condition: VBAT = 2.7~5.5V, T<sub>A</sub> = 25°C, Unless otherwise specified.

PARAMETER	SYMBOL	CONDITION	MIN	TYP	MAX	UNIT
Supply voltage range (PVBAT, AVBAT)	VBAT		2.7	3.7	5.5	V
Power-up threshold voltage	V <sub>UVLH</sub>			2.7		V
Power-off threshold voltage	V <sub>UVLL</sub>				2.5	V
Quiescent current	I <sub>BAT</sub>	3.6V, No input, No load, Class D		3.6		mA
		3.6V, No input, No load, Class AB		6.9		mA
Shutdown current	I <sub>SD</sub>			0.1		uA
Input impedance per input pin	R <sub>in</sub>			18		kΩ
Closed-loop voltage gain	A <sub>v</sub>	R <sub>IN</sub> = 0ohm, Class D		28.8		dB
		R <sub>IN</sub> = 0ohm, Class AB		22.8		dB
CTRL terminal setting threshold voltage	V <sub>CTRL</sub>	Shutdown mode	0		0.2	V
		Class AB mode, Charge Pump disabled	0.7		1.2	V
		Class D mode, Charge Pump adaptively enabled, ACF on	1.6		2.2	V
		Class D mode, Charge Pump adaptively enabled, ACF off	2.5		AVBAT	V
Start-up time <sup>5</sup>	t <sub>ON</sub>			80		ms
Over temperature protection point	OTP			150		°C

**Charge Pump Specifications**

Condition: VBAT = 2.7~5.5V, T<sub>A</sub> = 25°C, Unless otherwise specified.

PARAMETER	SYMBOL	CONDITION	MIN	TYP	MAX	UNIT
Charge pump output voltage	PVDD			6.6		V
Switching frequency	f <sub>SW_CH</sub>			1100		kHz
Max output current	I <sub>PVDD</sub>	VBAT=4.2V		2		A

<sup>3</sup> Depending on parts and PCB layout, characteristics may be changed.

<sup>4</sup> Stresses beyond those listed under absolute maximum ratings may cause permanent damage to the device. These are stress ratings only, and functional operation of the device at these or any other conditions beyond those indicated under recommended operating conditions is not implied. Exposure to absolute-maximum-rated conditions for extended periods may affect device reliability.

<sup>5</sup> Power on, shutdown release, or the switching between Class AB and Class D





### Class D Audio Amplifier Specifications

Condition: V<sub>BAT</sub> = 3.7V, T<sub>A</sub> = 25°C, C<sub>IN</sub> = 1uF, R<sub>IN</sub> = 0k, A<sub>v</sub> = 28.8dB, R<sub>L</sub> = 4Ω, f<sub>IN</sub> = 1kHz, C<sub>V<sub>BAT</sub></sub> = 1uF//10uF//470uF, C<sub>OUT</sub> = 1uF//10uF//470uF, C<sub>FLY</sub> = 4.7uF, Unless otherwise specified.

PARAMETER	SYMBOL	CONDITION		MIN	TYP	MAX	UNIT
Output Power	P <sub>o</sub>	VBAT=5V	THD+N = 10%		5.5		W
		VBAT=5V	THD+N = 1%		4.5		
		VBAT=4.2V	THD+N = 10%		5.5		
		VBAT=4.2V	THD+N = 1%		4.5		
		VBAT=3.7V	THD+N = 10%		4.3		
		VBAT=3.7V	THD+N = 1%		3.8		
		VBAT=3.3V	THD+N = 10%		3.3		
		VBAT=3.3V	THD+N = 1%		2.9		
Total Harmonic Distortion + Noise	THD+N	P <sub>o</sub> =1W R <sub>L</sub> =4Ω, f=1kHz			0.08		%
Output Noise	V <sub>N</sub>	f=20Hz~20kHz, A weighted, A <sub>v</sub> =28.5dB			120		μV <sub>rms</sub>
		f=20Hz~20kHz, A weighted, A <sub>v</sub> =25dB			100		μV <sub>rms</sub>
Offset Voltage	V <sub>os</sub>				±5		mV
Efficiency	η	V <sub>BAT</sub> =3.7V, P <sub>o</sub> =0.4W			84		%
		V <sub>BAT</sub> =3.7V, P <sub>o</sub> =2W			72		%
Switching frequency	f <sub>SW_D</sub>				380		kHz

### Class AB Audio Amplifier Specifications

Condition: V<sub>BAT</sub> = 3.7V, T<sub>A</sub> = 25°C, C<sub>IN</sub> = 1uF, R<sub>IN</sub> = 0k, A<sub>v</sub> = 22.8dB, R<sub>L</sub> = 4Ω, f<sub>IN</sub> = 1kHz, C<sub>V<sub>BAT</sub></sub> = 1uF//10uF//470uF, C<sub>OUT</sub> = 1uF//10uF//470uF, C<sub>FLY</sub> = 4.7uF, Unless otherwise specified.

PARAMETER	SYMBOL	CONDITION		MIN	TYP	MAX	UNIT
Output Power	P <sub>o</sub>	VBAT=5V	f=1kHz, R <sub>L</sub> =4Ω, THD+N=10%		2.8		W
		VBAT=4.2V			2		
		VBAT=3.7V			1.5		
		VBAT=3.3V			1.2		
		VBAT=5V	f=1kHz, R <sub>L</sub> =4Ω, THD+N=1%		2.3		
		VBAT=4.2V			1.6		
		VBAT=3.7V			1.2		
		VBAT=3.3V			0.9		
Total Harmonic Distortion + Noise	THD+N	P <sub>o</sub> =1W	R <sub>L</sub> =4Ω, f=1kHz		0.06		%
Output Noise	V <sub>N</sub>	f=20Hz~20kHz, A weighted, A <sub>v</sub> =22.8dB			63		μV <sub>rms</sub>
		f=20Hz~20kHz, A weighted, A <sub>v</sub> =19dB			50		μV <sub>rms</sub>
Offset Voltage	V <sub>os</sub>				±5		mV
Efficiency	η	P <sub>o</sub> = 1W			61		%



## ■ HT8313 TYPICAL OPERATING CHARACTERISTICS

Class D Mode, V<sub>BAT</sub> = 4.2V, f<sub>IN</sub> = 1kHz, Load = 4ohm, P<sub>o</sub> = 1W, unless otherwise specified.

V<sub>BAT</sub> vs I<sub>BAT</sub>

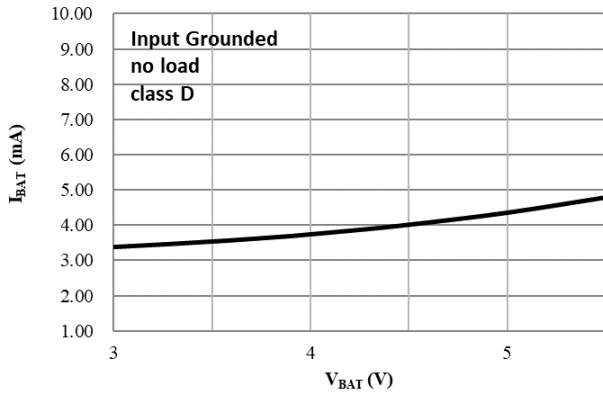

P<sub>o</sub> vs η

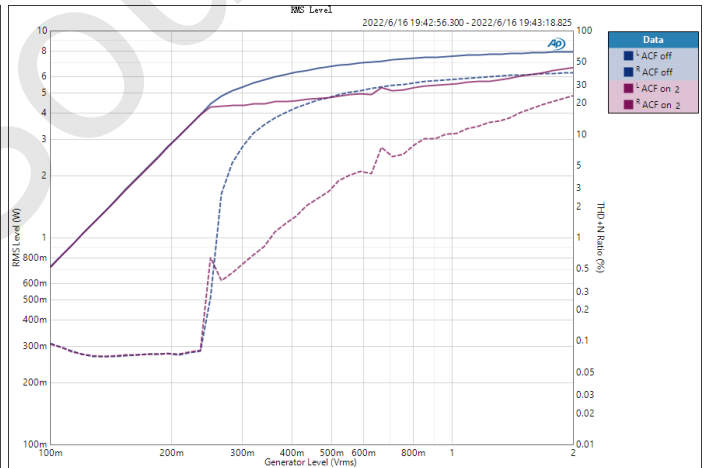
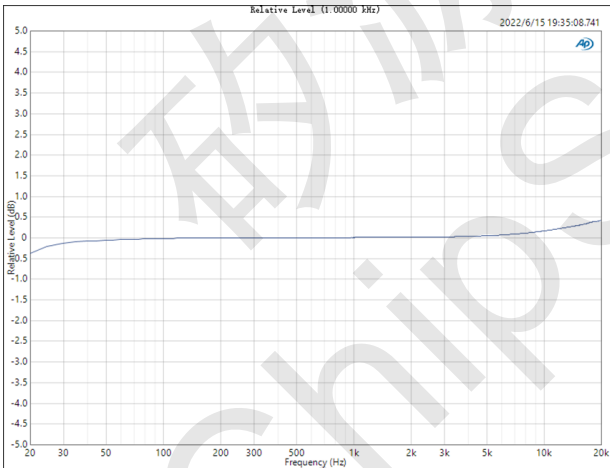
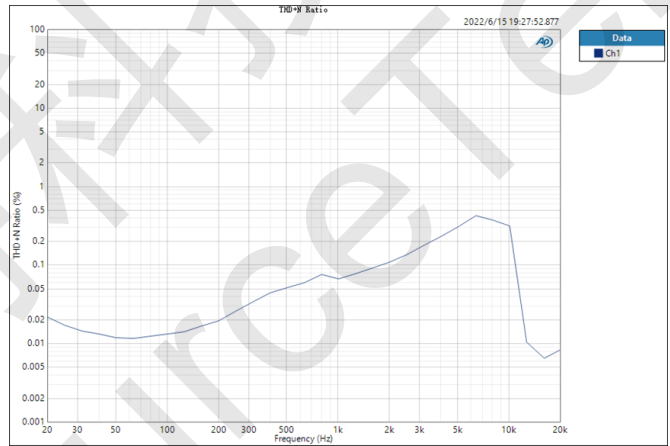
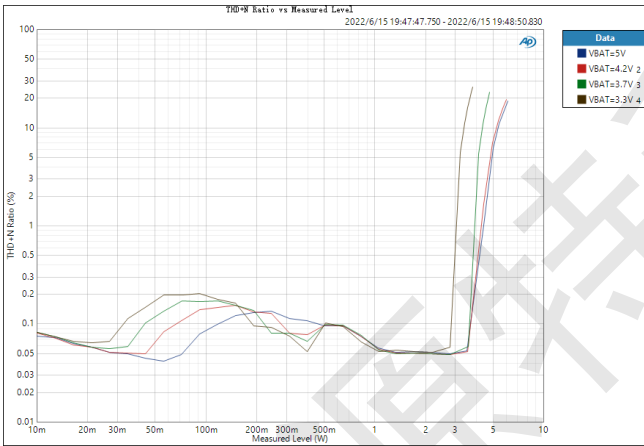
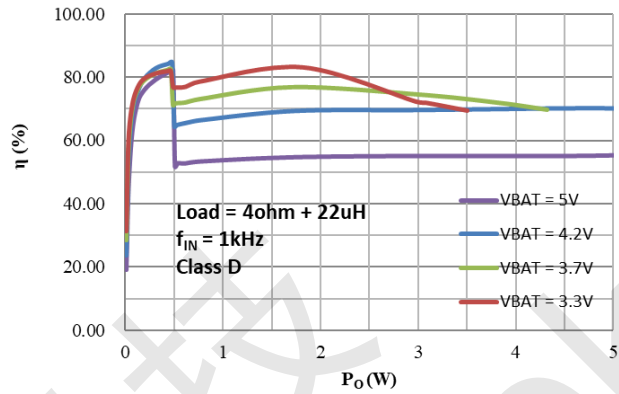



Class AB Mode, V<sub>BAT</sub> = 4.2V, f<sub>IN</sub> = 1kHz, Load = 4ohm, P<sub>O</sub> = 1W, unless otherwise specified.

V<sub>BAT</sub> vs I<sub>BAT</sub>

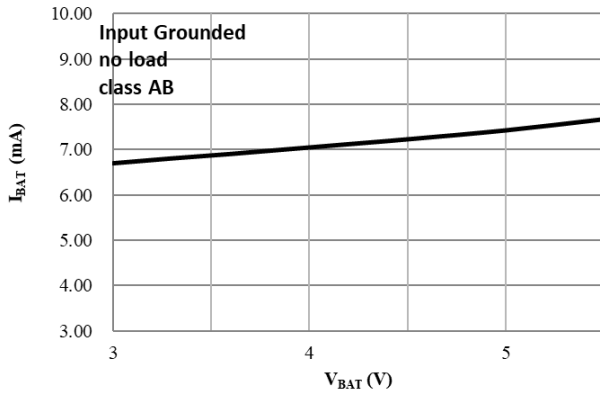

P<sub>O</sub> vs η

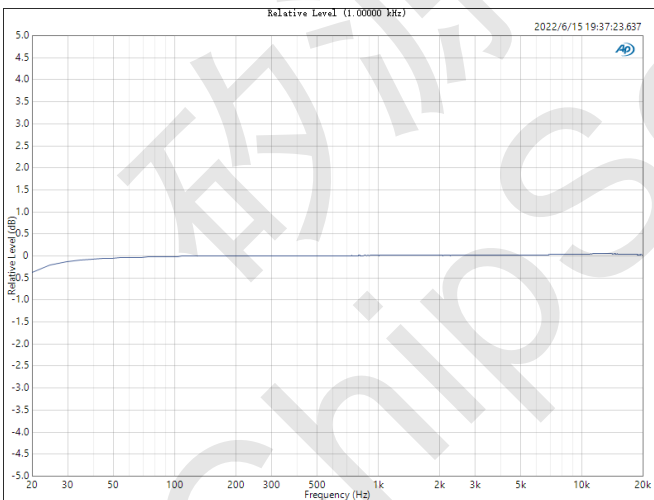
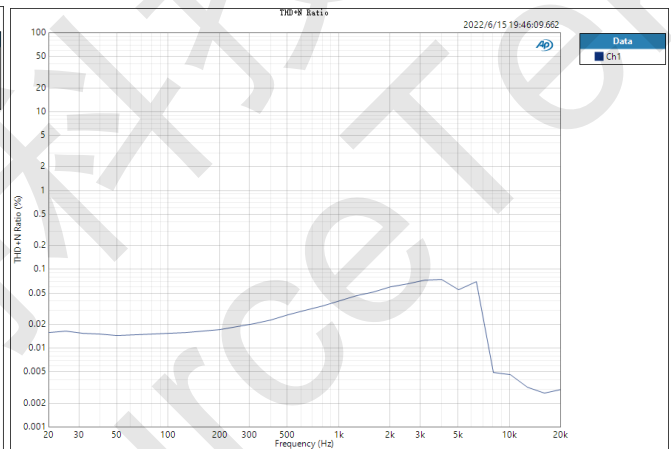
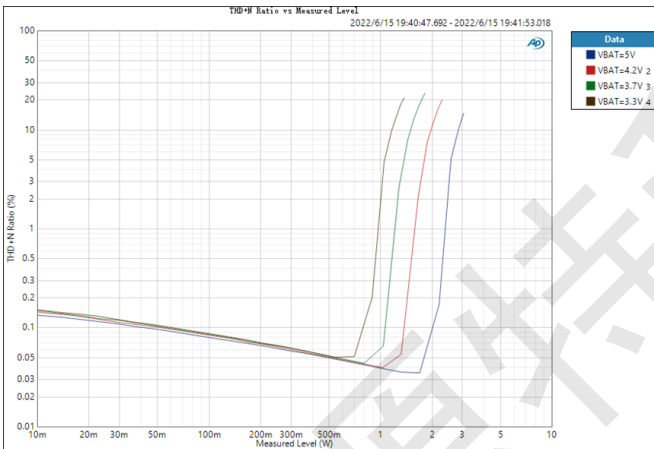
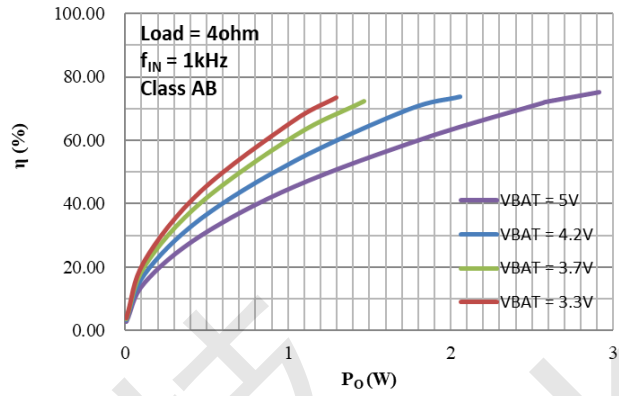





## ■ HT8313 APPLICATION INFORMATION

The HT8313 is a highly efficient 5.5W Class-D audio power amplifier with anti-clipping function (ACF) for applications of battery-powered portable devices. It integrates a filter-less Class-D audio amplifier with an adaptive charge pump regulator. It operates from 2.7V to 5.5V supply. When operating with a 4.2V supply voltage, the HT8313 can deliver into a 4Ω load a maximum output power up to 5.5W with 10% THD+N.

In HT8313, the power supply rail of the Class-D amplifier output stage is internally boosted and regulated at 6.6V by an adaptive charge pump regulator, allowing for a much louder audio output than a stand-alone one directly connected to the battery. It makes HT8313 an ideal audio solution for portable devices, which are powered by a single-cell lithium battery while requiring higher audio loudness.

The HT8313 features ACF to constantly monitor and safeguard the audio outputs against the boosted supply voltage, preventing output clipping distortion, excessive power dissipation, or hazardous speaker over-load. Once an over-level condition is detected, the ACF lowers the voltage gain of the audio amplifier proportionally to eliminate output clipping distortion while maintaining a maximum dynamic range of the audio outputs allowed by the boosted supply voltage.

Class AB amplifier mode is also available for HT8313. Once the EMI Interference from class D and Boost Converter becomes an annoying problem, HT8313 can be changed into Class AB mode.

As specifically designed for portable device applications, the HT8313 incorporates a shutdown mode to minimize the power consumption by holding the CTRL pin to ground. It also includes comprehensive protection features against various operating faults such as over-current, over-temperature, and under-voltage for a safe and reliable operation.

### 1. Charge Pump Regulator

To allow for a much louder audio output, an integrated adaptive charge pump regulator is employed to boost PVDD, the power rail for the Class-D amplifier output stage. Whenever the audio outputs are higher than a prescribed level, the charge pump regulator will be activated to boost and regulate PVDD at 6.6V. In this case, the charge pump regulator operates in the regulation mode. For a proper operation, the boosted voltage PVDD generated by the charge pump regulator must be externally shorted to PVDD pins via a sufficiently wide metal trace on the system board.

On the other hand, when the audio outputs are less than a prescribed level for an extended period of time, the charge pump regulator will be de-biased and forced into the standby mode. In the standby mode, the amplifier output stage is powered directly by VBAT, the battery voltage, through an internal power switch. This adaptive nature of the charge pump regulator can greatly improve the power efficiency of HT8313 when playing audio and thus extends battery life.

#### 1.1. Selection of Charge Pump Flying Capacitor ( $C_{FLY}$ )

A nominal value of 4.7μF is recommended for the flying capacitors (between CP and CN) of the charge pump regulator. A low equivalent-series-resistance (ESR) ceramic capacitor, such as X7R or X5R, is recommended.

#### 1.2. Selection of Charge Pump Output Capacitor ( $C_{OUT}$ )

For best performance, a 10μF low ESR ceramic capacitor in parallel with a 1μF ceramic capacitor is recommended for the output capacitor ( $C_{OUT}$ ) of the charge pump regulator. For a better audio performance in large power situation, another tantalum or electrolytic capacitor (220μF or higher) can be paralleled.



## 2. Anti-Clipping Function (ACF) and Mode Configuration

Once the ACF function is enabled, HT8313 attenuates system gain to an appropriate value when an excessive input is applied, so as not to cause the clipping at the differential signal output. In this way, the output audio signal is controlled in order to obtain a maximum output level without distortion. And HT8313 also follows to the clips of the output waveform due to the decrease in the power-supply voltage.

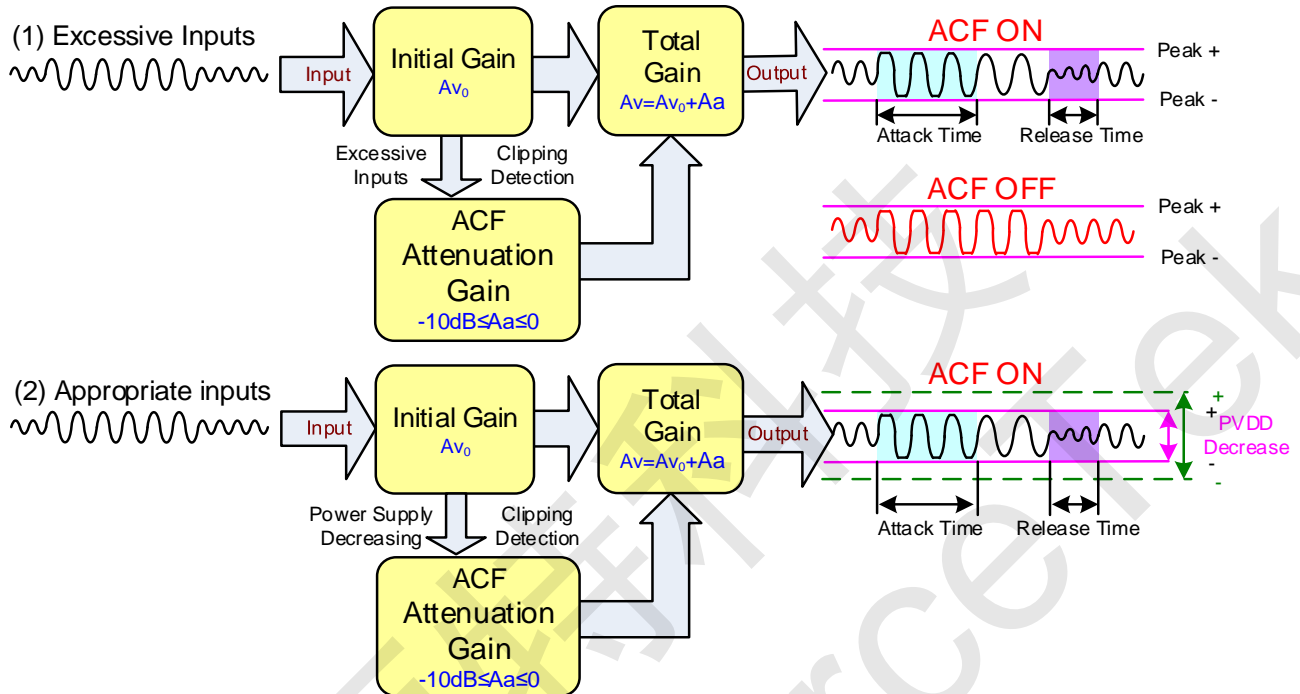

Fig. 1 the ACF Function Operation Outline

The Attack time of ACF Function is a time interval until system gain falls to target attenuation gain -3dB when a big enough signal input. And the Release Time is a time from target attenuation gain to not working of ACF. The maximum attenuation gain is 10dB.

For HT8313, the attack time is 50ms, and the release time is 300ms.

## 3. Audio Amplifier Input Configuration

HT8313 is an amplifier with analog input (single-ended or differential). For a differential input between IN+ and IN- pins, signals input via DC-cut capacitors ( $C_{IN}$ ) and input resistor ( $R_{IN}$ , optional). In class D mode, the input signal gain is calculated by

$$A_v \approx 20 \times \log \frac{510k}{18k + R_{IN}}$$

In class AB mode, the input signal gain is calculated by

$$A_v \approx 20 \times \log \frac{255k}{18k + R_{IN}}$$

And, the low pass cut-off frequency of input signal, can be calculated by

$$f_c \approx \frac{1}{2\pi(18k + R_{IN})C_{CIN}}$$



For a single-ended input at IN+ pin, signal input via a DC-cut capacitor ( $C_{IN}$ ) and input resistor ( $R_{IN}$ , optional). IN- pin should be connected to ground via a DC-cut capacitor and a input resistor (with the same value of  $C_{IN}$  and  $R_{IN}$ ). The Gain and low pass Cut-off frequency are the same as the above case.

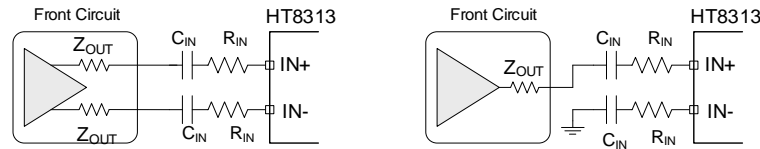

Fig. 2 (1) Differential Input;

(2) Single-ended Input

#### 4. Working Mode Selection (CTRL Terminal)

HT8313 can work in different modes by setting the CTRL terminal, shown as follow.

Table. 1 CTRL Terminal Mode Control

MODE	SYMBOL	CTRL Voltage			
		MIN.	TYP.	MAX.	UNIT
Class D mode, ACF OFF, Charge Pump adaptively enabled	$V_{MOD1}$	2.5		AVBAT	V
Class D mode, ACF ON, Charge Pump adaptively enabled	$V_{MOD2}$	1.6		2.2	V
Class AB mode, ACF off, Charge Pump disabled	$V_{MOD3}$	0.9	1.2	1.5	V
SD (Shutdown) Mode	$V_{MOD4}$	0	0	0.4	V

Notice that there's no internal pull-up or pull-down resistor.

#### 5. Pop-Click Noise Reduction

The Pop-Click Noise Reduction Function of HT8313 works in the cases of Power-on, Power-off, Shutdown on, and Shutdown off. To achieve a more excellent noise reduction performance, it is recommended to use a DC-cut capacitor ( $C_{IN}$ ) of 0.1 $\mu$ F or less.

Besides, POP noise can be minimal according to the following procedure of shutdown control.

- During power-on, Shutdown mode is not cancelled until the power supply is stabilized enough.
- Before Power-off, set Shutdown mode first.

The pop-click noise: Power-on/-off > Shutdown on/off.

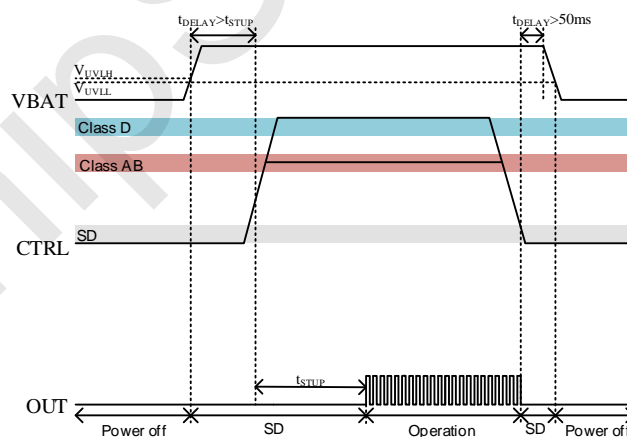

Fig. 3 Pop-Click Noise Reduction by Shutdown



## 6. Protection Function

HT8313 has the protection functions such as Over-Current Protection function, Thermal Protection function, and Low Voltage Malfunction Prevention function.

### (1) Over-current Protection function

When a short circuit occurs between one output terminal and Ground, PVDD, or the other output, the over-current protection mode starts up. In the over current protection mode, the differential output terminal becomes a high impedance state. Once the short circuit conditions are eliminated, the over current protection mode can be cancelled automatically.

### (2) Thermal Protection function

When excessive high temperature of HT8313 (160°C) is detected, the thermal protection mode starts up. In the thermal protection mode, the differential output terminal becomes Weak Low state (a state grounded through high impedance).

### (3) Low voltage Malfunction Prevention function

This is the function to establish the low voltage protection mode when AVBAT terminal voltage becomes lower than the detection voltage ( $V_{UVLL}$ ) for the low voltage malfunction prevention. And the protection mode is canceled when AVBAT terminal voltage becomes higher than the threshold voltage ( $V_{UVLH}$ ). In the low voltage protection mode, the differential output pin becomes Weak Low state (a state grounded through high impedance). HT8313 will start up within the start-up time ( $T_{ON}$ ) when the low voltage protection mode is cancelled.

## 7. Typical Application Circuits

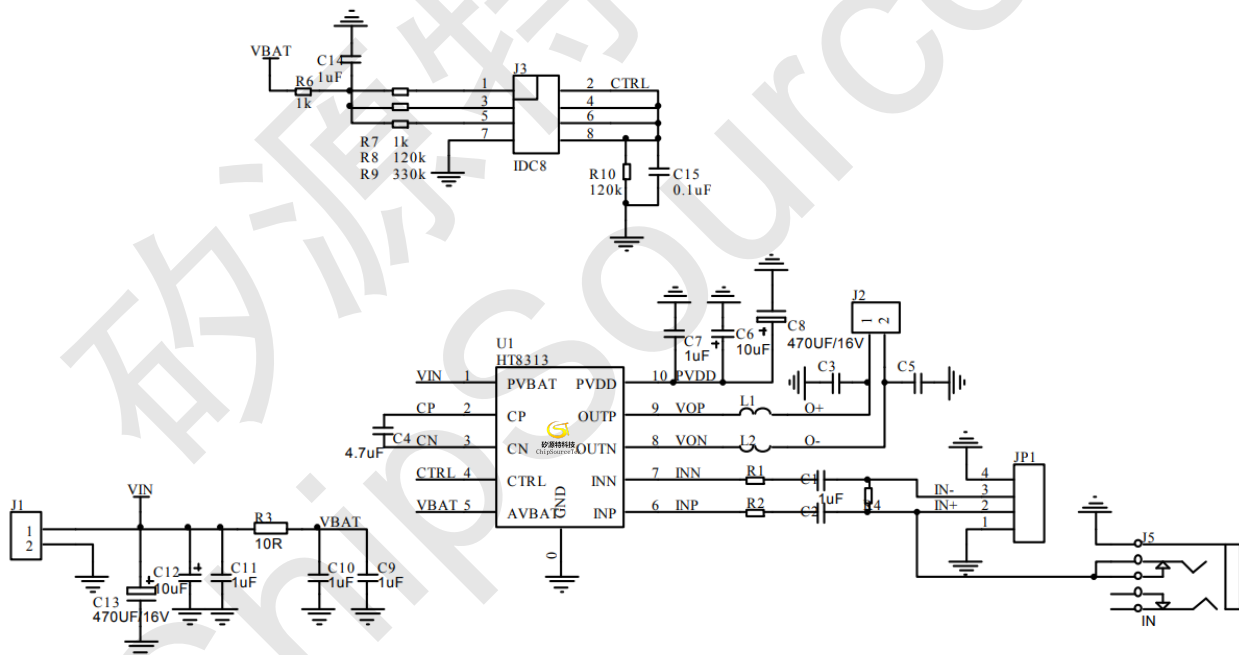



### 8. Typical PCB Layout

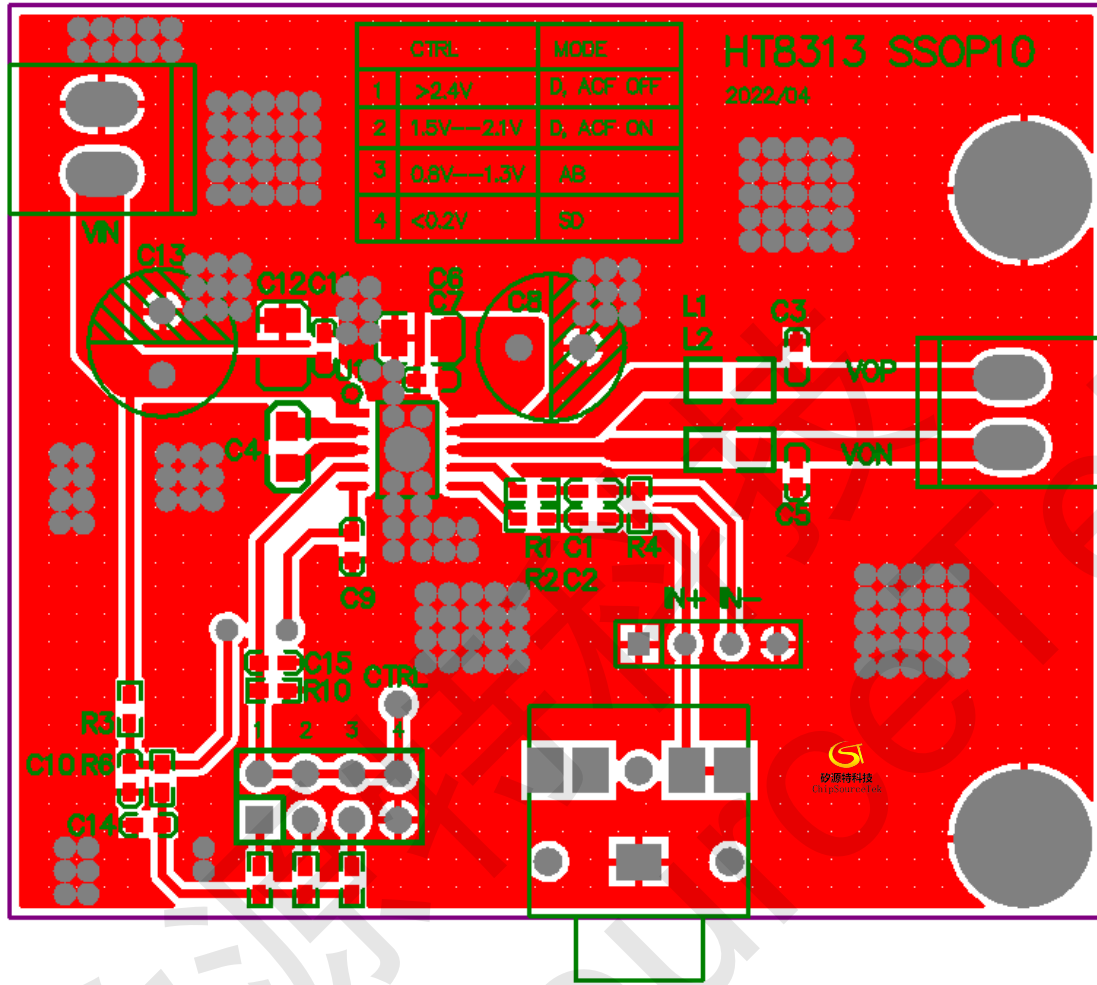



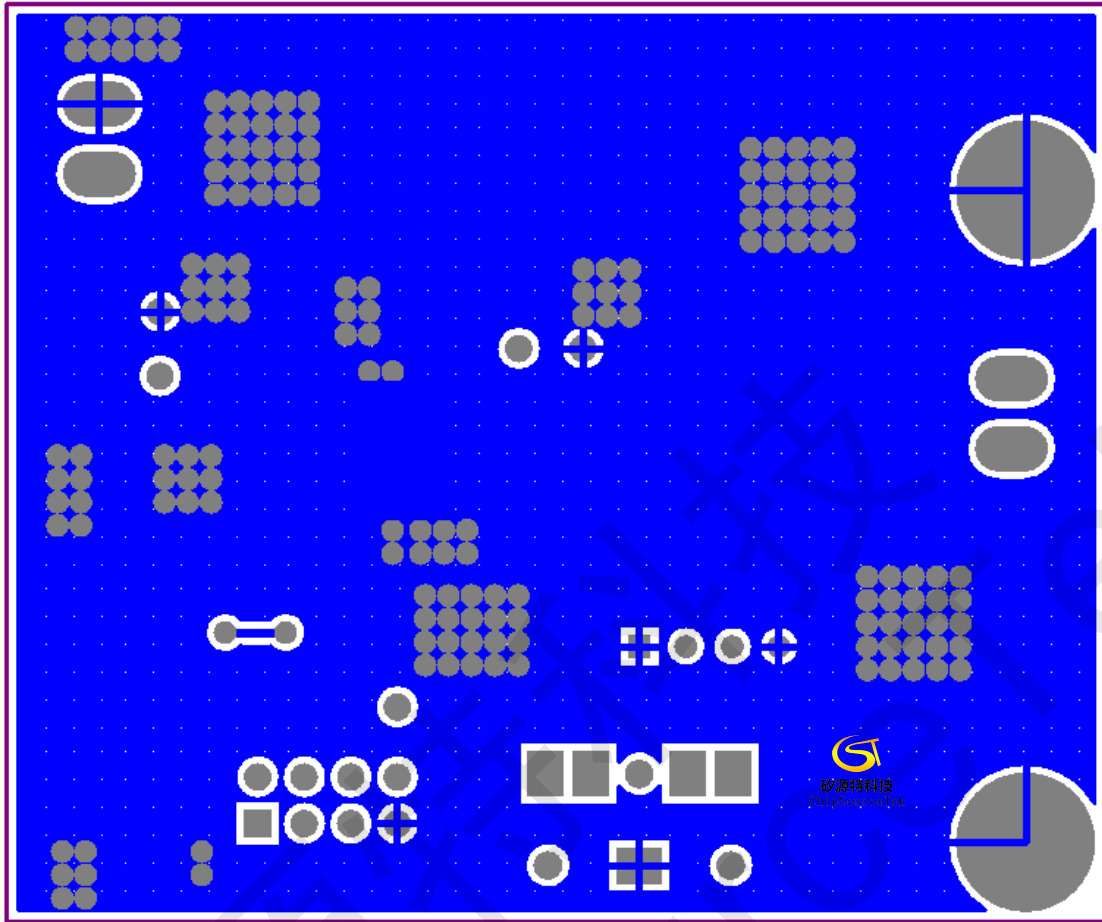

矽源特科技  
ChipSourceTek





■ HT8313 PACKAGE

OUTLINE

SOP10L-PP

TOP VIEW  
正视图

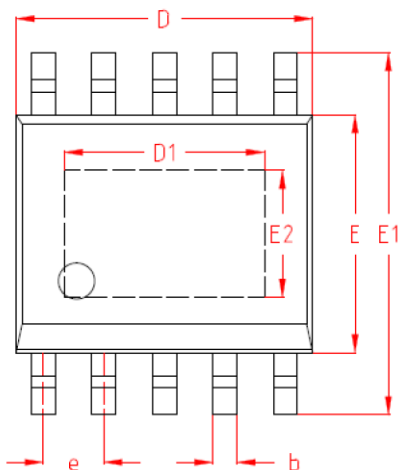

SIDE VIEW  
侧视图

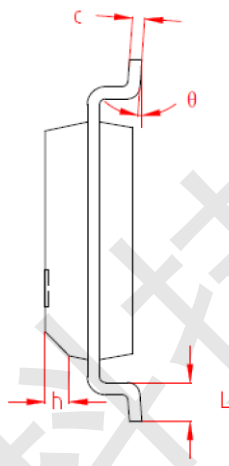

SIDE VIEW  
侧视图

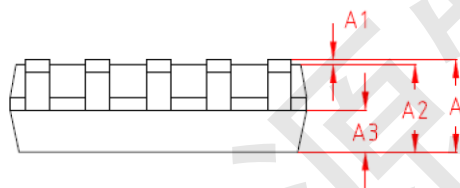

机械尺寸/mm Dimensions			
字符 SYMBOL	最小值 MIN	典型值 NOMINAL	最大值 MAX
A	1.50	1.60	1.70
A1	0.04	-	0.12
A2	1.35	1.45	1.55
A3	0.65	0.70	0.75
b	0.35	-	0.50
c	0.19	-	0.25
D	4.80	4.90	5.00
D1	3.20	3.30	3.40
E	3.80	3.90	4.00
E1	5.80	6.00	6.20
E2	2.00	2.10	2.20
e	1.00 BSC		
h	0.30	-	0.50
L	0.50	-	0.80
$\theta$	0°	-	8°