

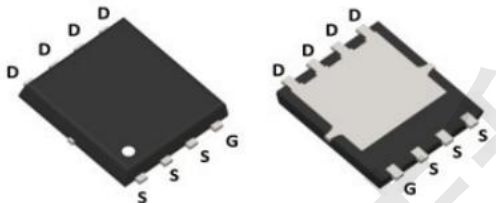
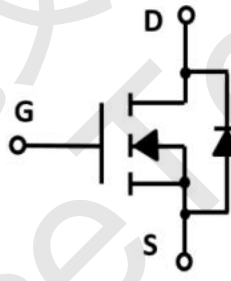

FMB6050G N-Channel Trench Power MOSFET

FMB6050G Description

Features <ul style="list-style-type: none">• 60V,50A• $R_{DS(ON)}=12.1m\Omega$ (Typ.) @ $V_{GS}=10V$• $R_{DS(ON)}=14.6m\Omega$ (Typ.) @ $V_{GS}=4.5V$• Advanced Trench Technology• Provide Excellent $R_{DS(ON)}$ and Low Gate Charge• 100% UIS Tested	Application <ul style="list-style-type: none">• LCD TV• Notebook• Elevator• Inductive heating• Power tools• Broadband
Package  PDFN-8 (5*6)	 Schematic diagram

FMB6050G Package Marking and Ordering Information

Product ID	PACK	Qty (pcs)
FMB6050G	PDFN-8(5*6)	4000

FMB6050G Absolute Maximum Ratings ($T_C=25^\circ\text{C}$ unless otherwise specified)

Symbol	Parameter	Value	Units	
V_{DSS}	Drain-Source Voltage	60	V	
V_{GSS}	Gate-Source Voltage	± 20	V	
I_D	Continuous Drain Current	$T_C = 25^\circ\text{C}$	50	A
		$T_C = 100^\circ\text{C}$	23	A
I_{DM}	Pulsed Drain Current ^{note1}	109	A	
E_{AS}	Single Pulsed Avalanche Energy ^{note2}	121	mJ	
P_D	Power Dissipation	$T_C = 25^\circ\text{C}$	27	W
$R_{\theta JC}$	Thermal Resistance, Junction to Case	4.7	$^\circ\text{C}/\text{W}$	
T_J, T_{STG}	Operating and Storage Temperature Range	-55 to +150	$^\circ\text{C}$	



FMB6050G Electrical Characteristics ($T_c=25^\circ\text{C}$ unless otherwise specified)

Symbol	Parameter	Test Condition	Min.	Typ.	Max.	Units
Off Characteristic						
$V_{(BR)DSS}$	Drain-Source Breakdown Voltage	$V_{GS}=0V, I_D=250\mu A$	60	-	-	V
I_{DSS}	Zero Gate Voltage Drain Current	$V_{DS}=60V, V_{GS}=0V,$	-	-	1.0	μA
I_{GSS}	Gate to Body Leakage Current	$V_{DS}=0V, V_{GS}=\pm 20V$	-	-	± 100	nA
On Characteristics						
$V_{GS(th)}$	Gate Threshold Voltage	$V_{DS}=V_{GS}, I_D=250\mu A$	1.0	1.6	2.0	V
$R_{DS(on)}$	Static Drain-Source on-Resistance note3	$V_{GS}=10V, I_D=20A$	-	12.1	15.7	m Ω
		$V_{GS}=4.5V, I_D=15A$	-	14.6	19.0	
g_{FS}	Forward Transconductance	$V_{DS}=5V, I_D=20A$	-	22	-	S
Dynamic Characteristics						
C_{iss}	Input Capacitance	$V_{DS}=30V, V_{GS}=10V,$ $f=1.0\text{MHz}$	-	2030	-	pF
C_{oss}	Output Capacitance		-	102	-	pF
C_{rss}	Reverse Transfer Capacitance		-	93	-	pF
R_g	Gate resistance		-	1.7	-	Ω
Switching Characteristics						
Q_g	Total Gate Charge	$V_{DS}=30V, I_D=20A,$ $V_{GS}=10V$	-	41	-	nC
Q_{gs}	Gate-Source Charge		-	5	-	nC
Q_{gd}	Gate-Drain("Miller") Charge		-	9	-	nC
$V_{plateau}$	Gate plateau voltage		-	2.6	-	V
$t_{d(on)}$	Turn-on Delay Time	$V_{DS}=30V, V_{GS}=10V$ $RL=1.5\Omega, R_{GEN}=3\Omega,$	-	6	-	ns
t_r	Turn-on Rise Time		-	5	-	ns
$t_{d(off)}$	Turn-off Delay Time		-	29	-	ns
t_f	Turn-off Fall Time		-	7	-	ns
Drain-Source Diode Characteristics and Maximum Ratings						
I_S	Maximum Continuous Drain to Source Diode Forward Current		-	-	50	A
I_{SM}	Maximum Pulsed Drain to Source Diode Forward Current		-	-	109	A
V_{SD}	Drain to Source Diode Forward Voltage	$V_{GS}=0V, I_S=10A$	-	-	1.2	V

- Notes: 1. Repetitive Rating: Pulse Width Limited by Maximum Junction Temperature
 2. EAS condition: $T_J=25^\circ\text{C}, V_{DD}=20V, V_G=10V, R_G=25\Omega, L=0.5\text{mH}$
 3. Pulse Test: Pulse Width $\leq 300\mu\text{s}$, Duty Cycle $\leq 0.5\%$



FMB6050G Typical Performance Characteristics

Figure 1: On-Region Characteristics

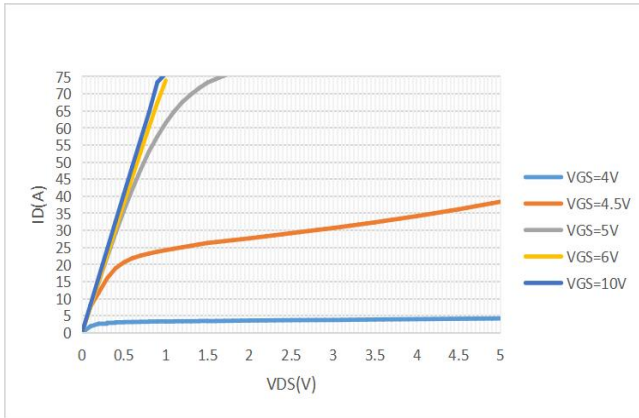

Figure 2: Transfer Characteristics

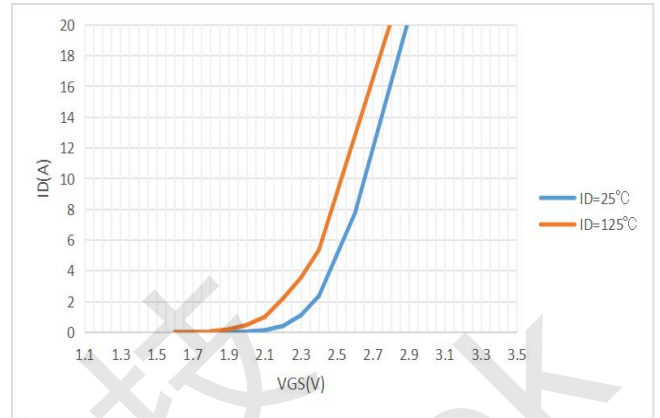

Figure 3: On-resistance vs. Drain Current and Gate Voltage

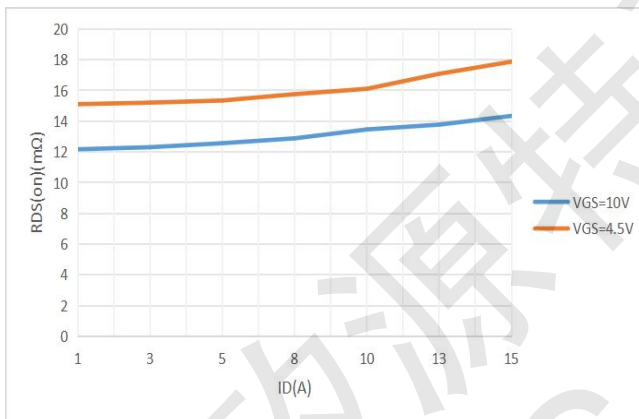

Figure 4: On-Resistance vs. Gate-Source Voltage

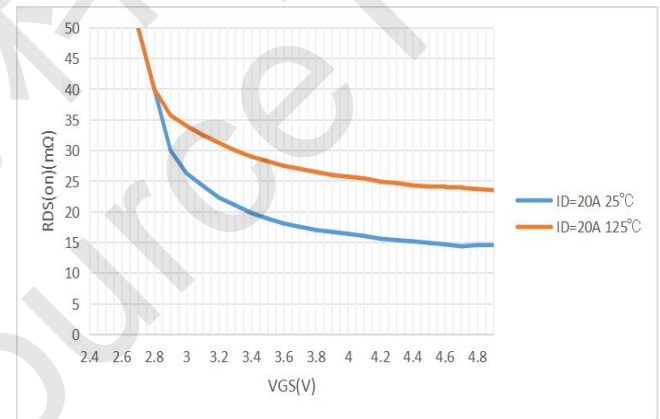

Figure 5: On-Resistance vs. Junction Temperature

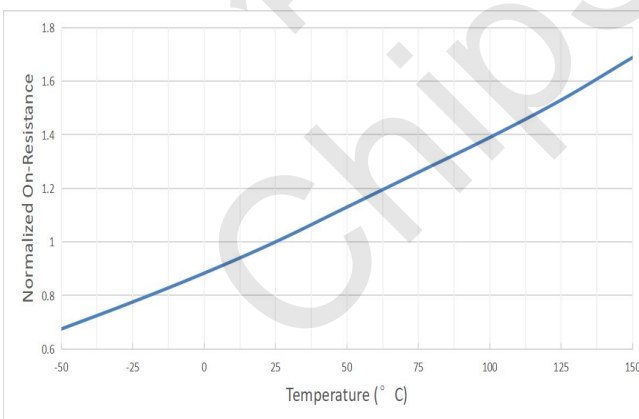
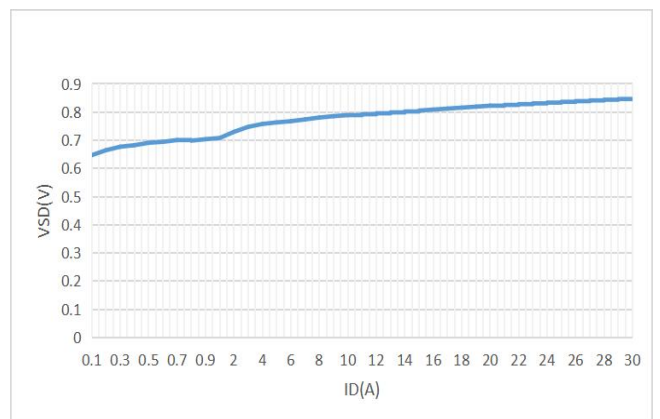

Figure 6: Body-Diode Characteristics





FMB6050G Typical Performance Characteristics

Figure7: Capacitance Characteristics C(pF)

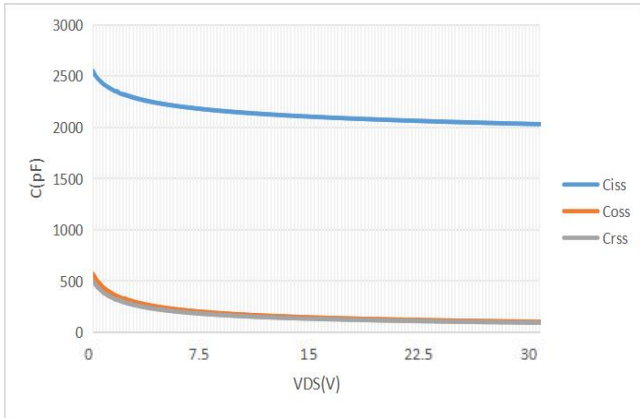

Figure 8: Gate-Charge Characteristics

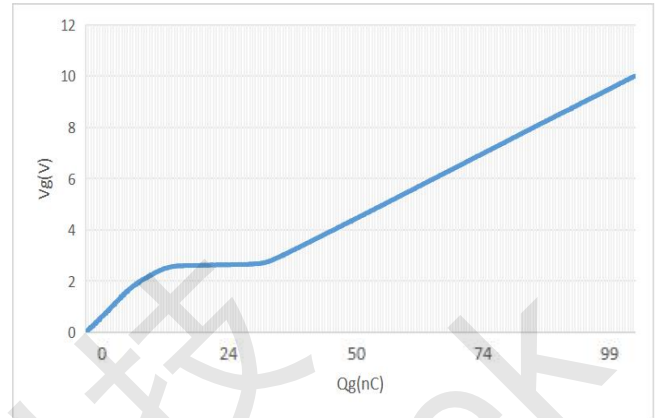

Figure9: Maximum Forward Biased Safe Operating Area

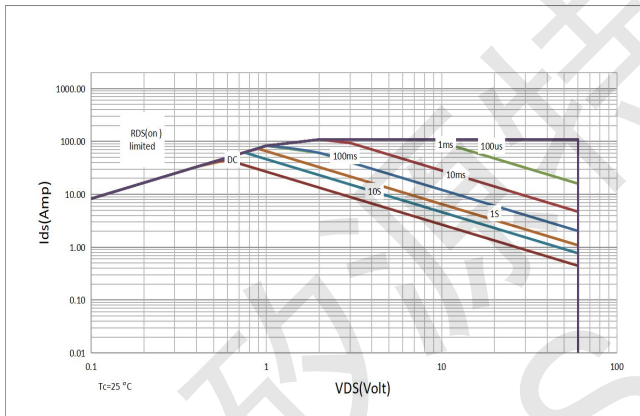
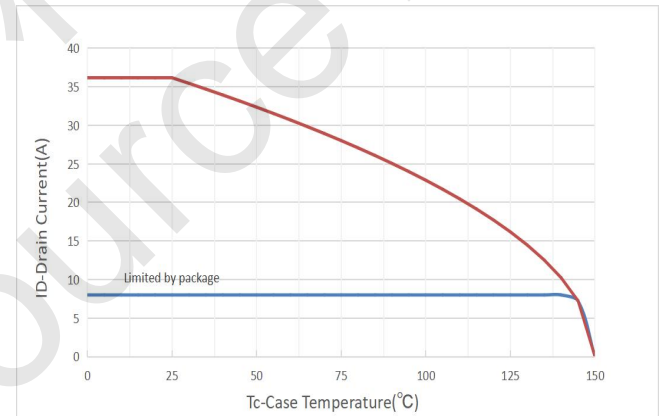

Figure 10: Current De-rating





FMB6050G Test Circuit

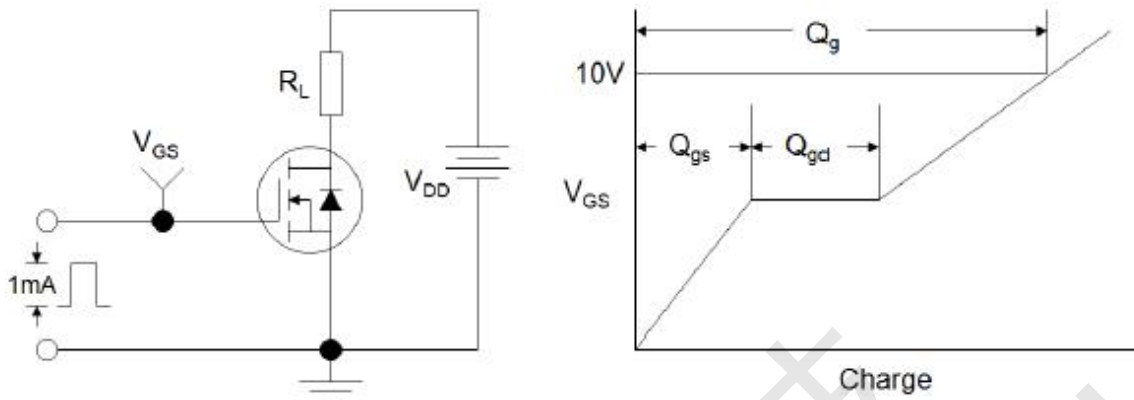

Figure1:Gate Charge Test Circuit & Waveform

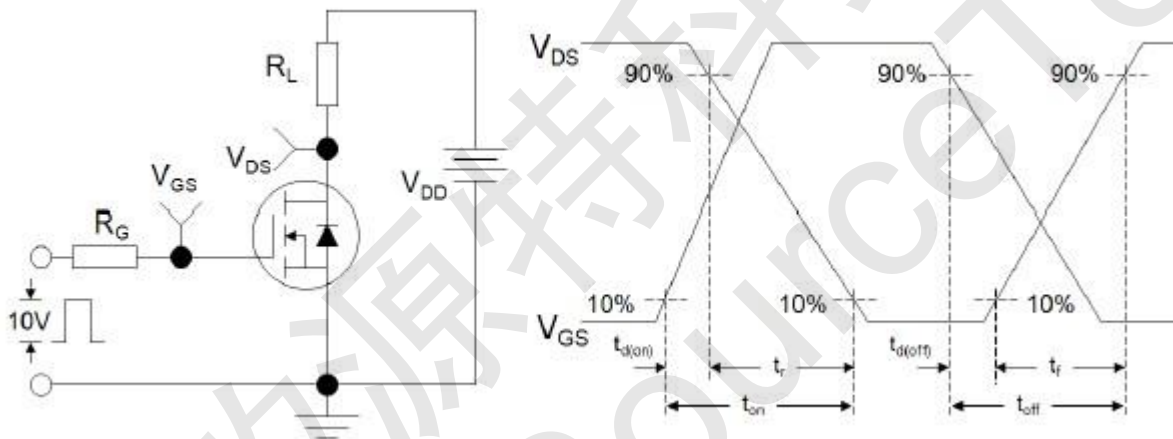

Figure 2: Resistive Switching Test Circuit & Waveforms

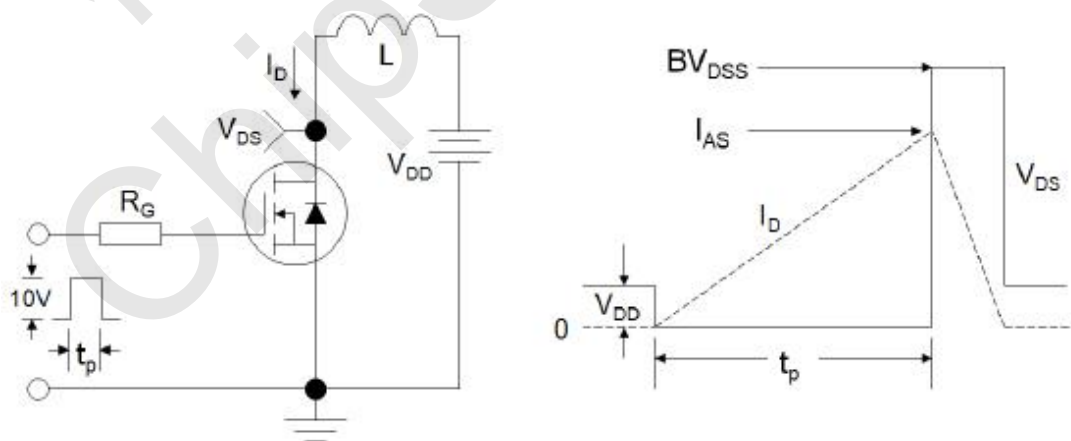

Figure 3:Unclamped Inductive Switching Test Circuit & Waveforms

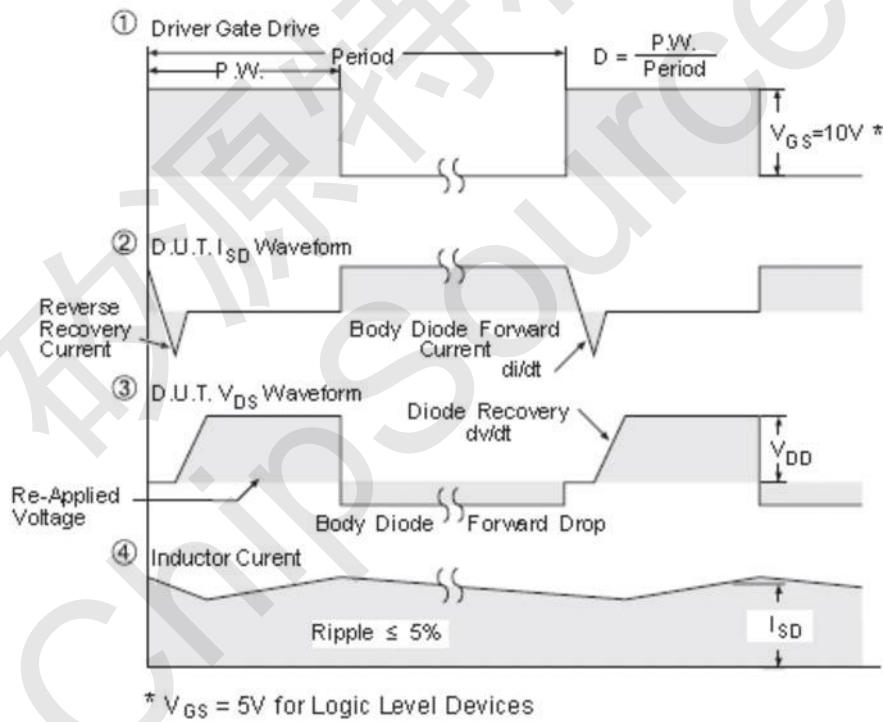
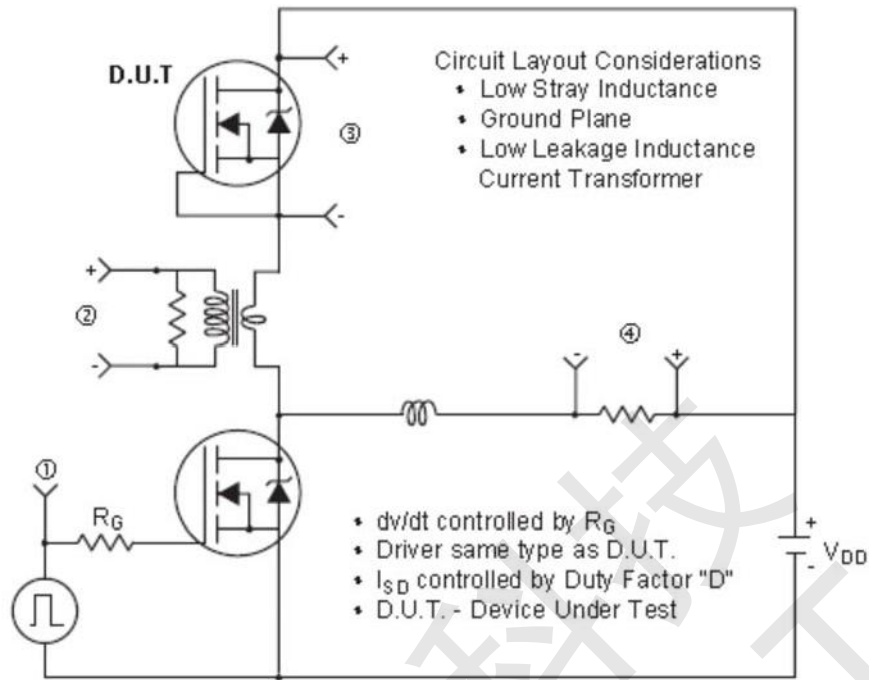
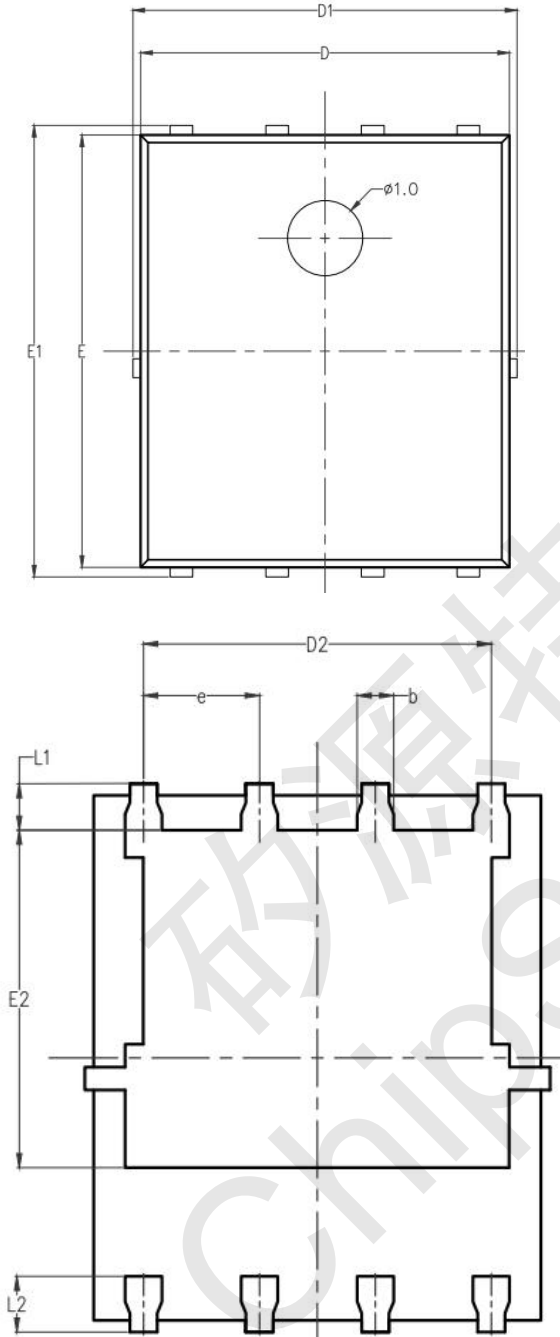

Figure 4: Peak Diode Recovery dv/dt Test Circuit & Waveforms (For N-channel)



FMB6050G PDFN5*6 Package Information



SYMBOL	MILLIMETER		
	MIN	NOM	MAX
A	0.95	1.00	1.05
A1	0.254REF.		
b	0.41	0.46	0.51
D	4.85	4.90	4.95
D1	4.90	5.00	5.10
D2	3.766	3.816	3.866
E	5.696	5.746	5.796
E1	5.95	6.00	6.05
E2	3.525	3.575	3.625
e	1.22	1.27	1.32
L1	0.46	0.51	0.56
L2	0.56	0.61	0.66