



### CST6946 Dual N-Ch 60V Fast Switching MOSFETs

- ★ Green Device Available
- ★ Super Low Gate Charge
- ★ Excellent CdV/dt effect decline
- ★ Advanced high cell density Trench technology

#### CST6946 Product Summary



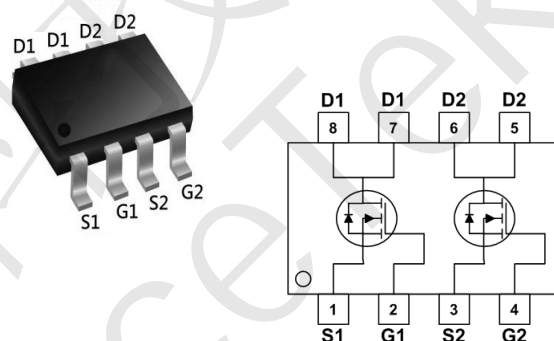
BVDSS	RDSON	ID
60V	28mΩ	6.0A

#### CST6946 Description

The CST6946 is the high cell density trenched N-ch MOSFETs, which provide excellent RDSON and gate charge for most of the synchronous buck converter applications.

The CST6946 meet the RoHS and Green Product requirement, 100% EAS guaranteed with full function reliability approved.

#### CST6946 SOP8 Pin Configuration



#### CST6946 Absolute Maximum Ratings

Symbol	Parameter	Rating	Units
$V_{DS}$	Drain-Source Voltage	60	V
$V_{GS}$	Gate-Source Voltage	$\pm 20$	V
$I_D@T_A=25^\circ C$	Continuous Drain Current, $V_{GS} @ 10V^1$	6.0	A
$I_D@T_A=70^\circ C$	Continuous Drain Current, $V_{GS} @ 10V^1$	4.5	A
$I_{DM}$	Pulsed Drain Current <sup>2</sup>	22	A
EAS	Single Pulse Avalanche Energy <sup>3</sup>	22	mJ
$I_{AS}$	Avalanche Current	23	A
$P_D@T_A=25^\circ C$	Total Power Dissipation <sup>4</sup>	1.5	W
$T_{STG}$	Storage Temperature Range	-55 to 150	$^\circ C$
$T_J$	Operating Junction Temperature Range	-55 to 150	$^\circ C$

#### CST6946 Thermal Data

Symbol	Parameter	Typ.	Max.	Unit
$R_{\theta JA}$	Thermal Resistance Junction-ambient <sup>1</sup>	---	85	$^\circ C/W$
$R_{\theta JC}$	Thermal Resistance Junction-Case <sup>1</sup>	---	25	$^\circ C/W$



#### CST6946 Electrical Characteristics (T<sub>J</sub>=25°C unless otherwise specified)

Symbol	Parameter	Test Condition	Min.	Typ.	Max.	Units
<b>Off Characteristic</b>						
V <sub>(BR)DSS</sub>	Drain-Source Breakdown Voltage	V <sub>GS</sub> =0V, I <sub>D</sub> =250μA	60	-	-	V
I <sub>DSS</sub>	Zero Gate Voltage Drain Current	V <sub>DS</sub> =60V, V <sub>GS</sub> = 0V,	-	-	1.0	μA
I <sub>GSS</sub>	Gate to Body Leakage Current	V <sub>DS</sub> =0V, V <sub>GS</sub> = ±20V	-	-	±100	nA
<b>On Characteristics</b>						
V <sub>GS(th)</sub>	Gate Threshold Voltage	V <sub>DS</sub> =V <sub>GS</sub> , I <sub>D</sub> =250μA	1.0	1.6	2.5	V
R <sub>DS(on)</sub>	Static Drain-Source on-Resistance <small>note3</small>	V <sub>GS</sub> =10V, I <sub>D</sub> =5A	-	28	40	mΩ
		V <sub>GS</sub> =4.5V, I <sub>D</sub> =3A	-	36	50	
<b>Dynamic Characteristics</b>						
C <sub>iss</sub>	Input Capacitance	V <sub>DS</sub> =25V, V <sub>GS</sub> =0V, f=1.0MHz	-	1148	-	pF
C <sub>oss</sub>	Output Capacitance		-	58.5	-	pF
C <sub>rss</sub>	Reverse Transfer Capacitance		-	49.4	-	pF
Q <sub>g</sub>	Total Gate Charge	V <sub>DS</sub> =30V, I <sub>D</sub> =2.5A, V <sub>GS</sub> =10V	-	20.3	-	nC
Q <sub>gs</sub>	Gate-Source Charge		-	3.7	-	nC
Q <sub>gd</sub>	Gate-Drain("Miller") Charge		-	5.3	-	nC
<b>Switching Characteristics</b>						
t <sub>d(on)</sub>	Turn-on Delay Time	V <sub>DS</sub> =30V, I <sub>D</sub> =5A, R <sub>G</sub> =1.8Ω, V <sub>GS</sub> =10V	-	7.6	-	ns
t <sub>r</sub>	Turn-on Rise Time		-	20	-	ns
t <sub>d(off)</sub>	Turn-off Delay Time		-	15	-	ns
t <sub>f</sub>	Turn-off Fall Time		-	24	-	ns
<b>Drain-Source Diode Characteristics and Maximum Ratings</b>						
I <sub>S</sub>	Maximum Continuous Drain to Source Diode Forward Current		-	-	5	A
I <sub>SM</sub>	Maximum Pulsed Drain to Source Diode Forward Current		-	-	20	A
V <sub>SD</sub>	Drain to Source Diode Forward Voltage	V <sub>GS</sub> =0V, I <sub>S</sub> =5A	-	-	1.2	V
trr	Body Diode Reverse Recovery Time	I <sub>F</sub> =5A, di/dt=100A/μs	-	29	-	ns
Q <sub>rr</sub>	Body Diode Reverse Recovery Charge		-	43	-	nC

Notes:1. Repetitive Rating: Pulse Width Limited by Maximum Junction Temperature

2. EAS condition : T<sub>J</sub>=25°C, V<sub>DD</sub>=30V, V<sub>G</sub>=10V, L=0.5mH, R<sub>G</sub>=25Ω, I<sub>AS</sub>=8.7A

3. Pulse Test: Pulse Width≤300μs, Duty Cycle≤0.5%



## CST6946 Typical Performance Characteristics

Figure 1: Output Characteristics

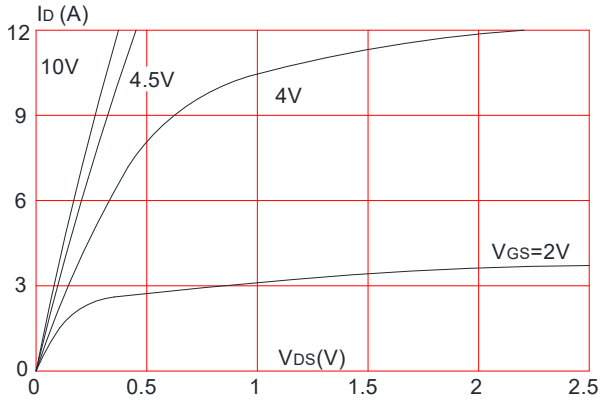


Figure 2: Typical Transfer Characteristics

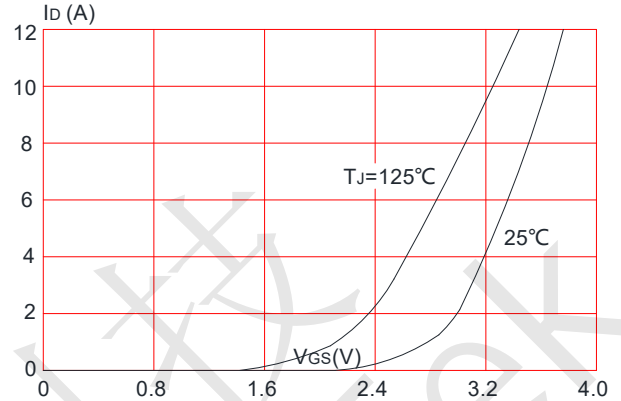


Figure 3: On-resistance vs. Drain Current

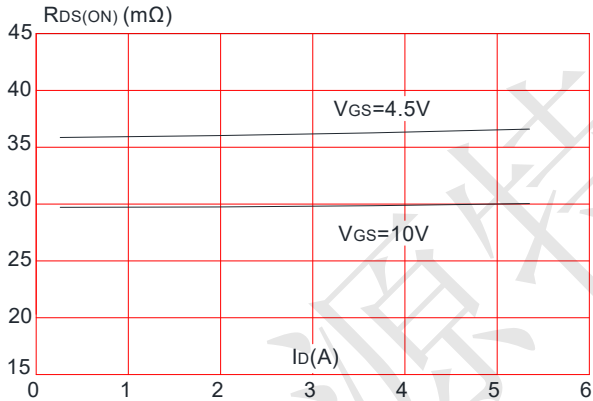


Figure 4: Body Diode Characteristics

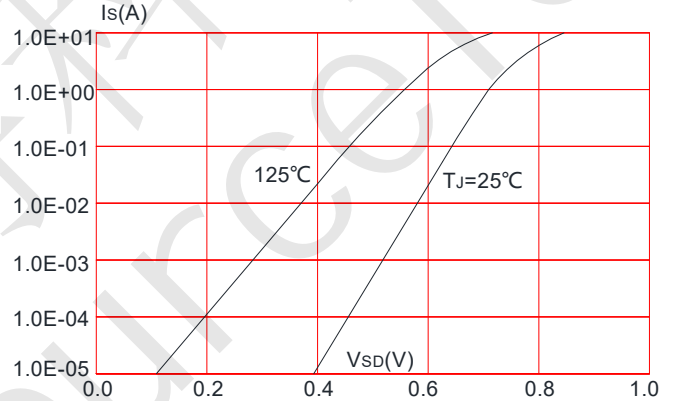


Figure 5: Gate Charge Characteristics

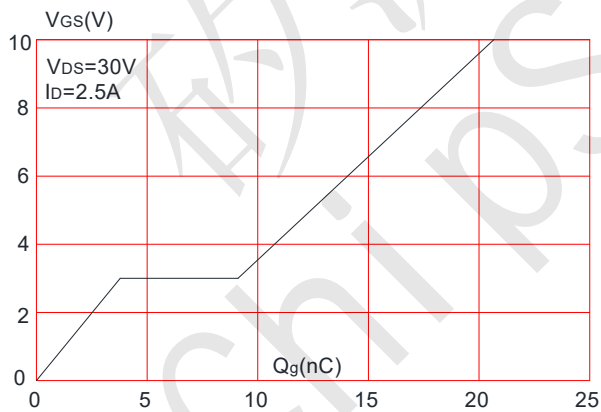
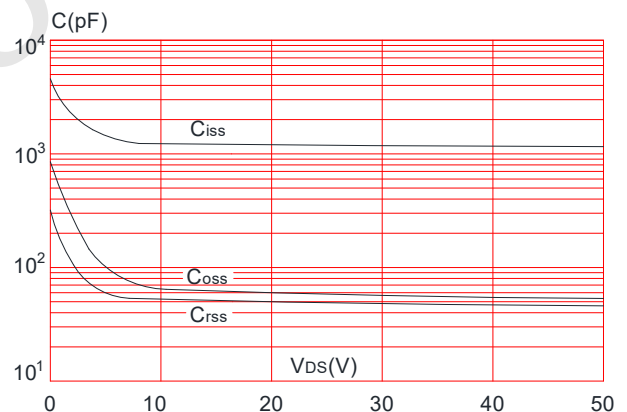


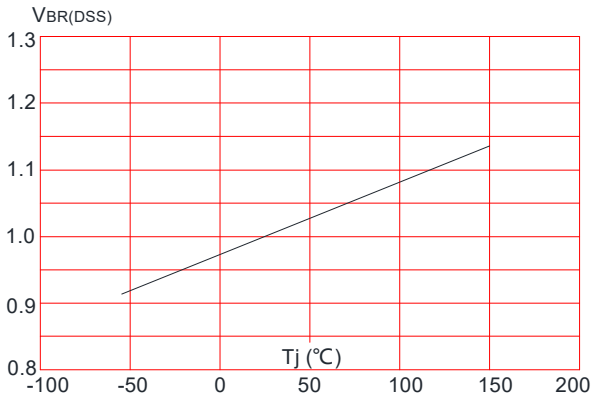
Figure 6: Capacitance Characteristics



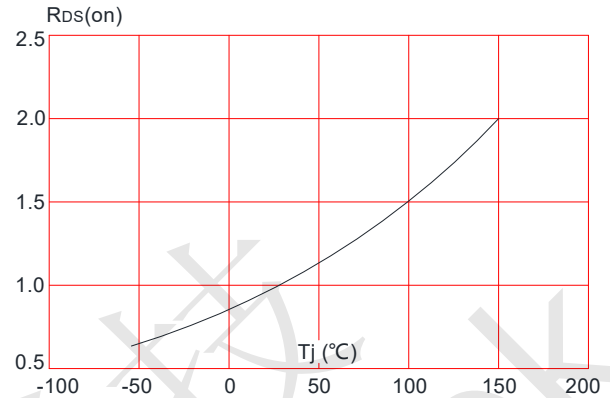


### CST6946 Dual N-Ch 60V Fast Switching MOSFETs

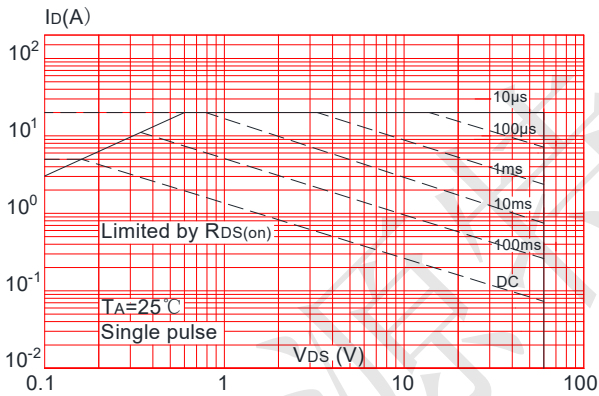
**Figure 7:** Normalized Breakdown Voltage vs. Junction Temperature



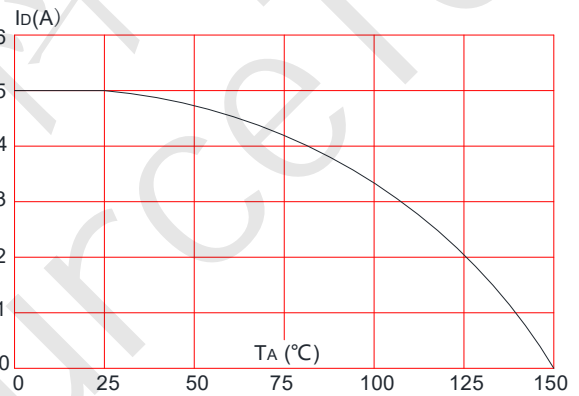
**Figure 8:** Normalized on Resistance vs. Junction Temperature



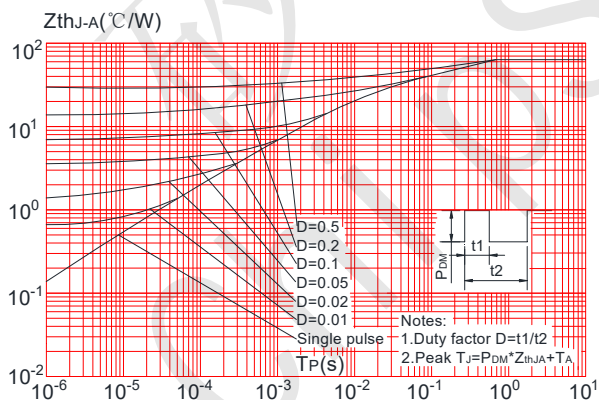
**Figure 9:** Maximum Safe Operating Area



**Figure 10:** Maximum Continuous Drain Current vs. Ambient Temperature

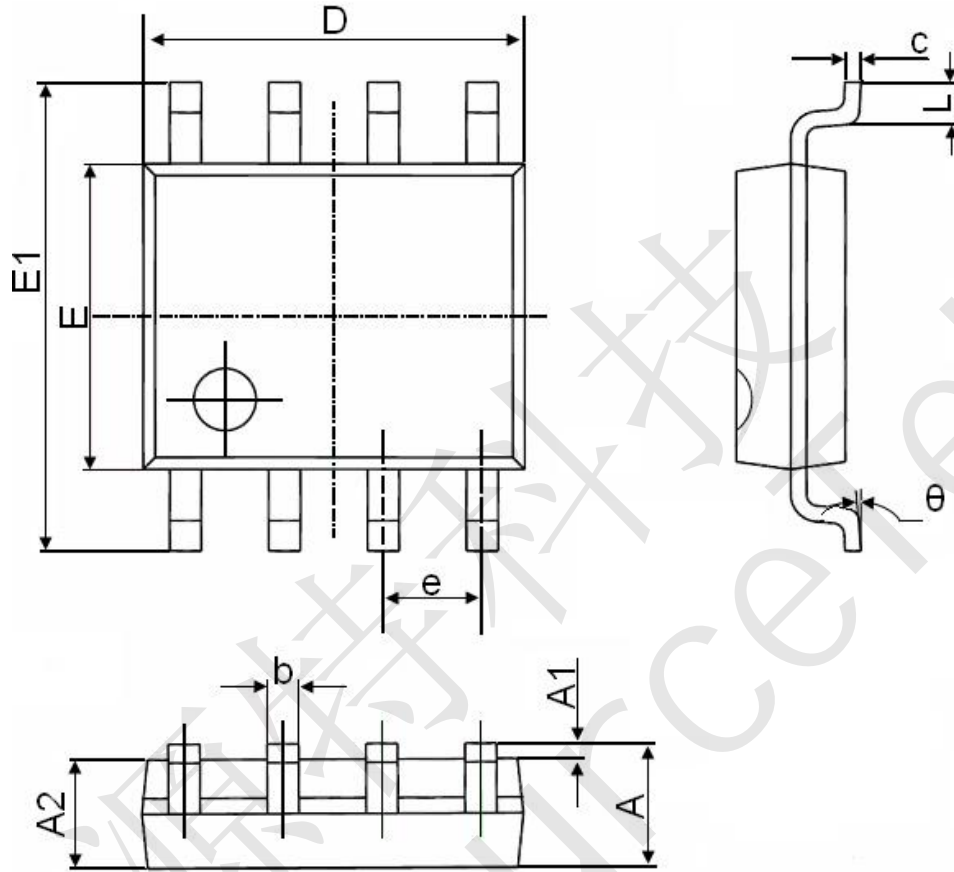


**Figure.11:** Maximum Effective Transient Thermal Impedance, Junction-to-Ambient





CST6946 SOP-8 Package Information



Symbol	Dimensions In Millimeters		Dimensions In Inches	
	Min.	Max.	Min.	Max.
A	1.350	1.750	0.053	0.069
A1	0.100	0.250	0.004	0.010
A2	1.350	1.550	0.053	0.061
b	0.330	0.510	0.013	0.020
c	0.170	0.250	0.006	0.010
D	4.700	5.100	0.185	0.200
E	3.800	4.000	0.150	0.157
E1	5.800	6.200	0.228	0.244
e	1.270(BSC)		0.050(BSC)	
L	0.400	1.270	0.016	0.050
θ	0°	8°	0°	8°