



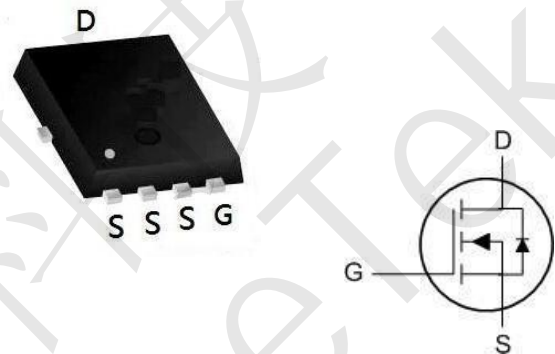
### CST60N02D N-Ch 20V Fast Switching MOSFETs

- ★ 100% EAS Guaranteed
- ★ Green Device Available
- ★ Super Low Gate Charge
- ★ Excellent CdV/dt effect decline
- ★ Advanced high cell density Trench technology

#### CST60N02D Product Summary

BVDSS	RDSON	ID
20V	4.0 mΩ	60A

#### CST60N02D PDFN3333-8L Pin Configuration



#### CST60N02D Description

The CST60N02D is the high cell density trenched N-ch MOSFETs, which provide excellent RDSON and gate charge for most of the synchronous buck converter applications.

The CST60N02D meet the RoHS and Green Product requirement, 100% EAS guaranteed with full function reliability approved.

#### CST60N02D Absolute Maximum Ratings

Symbol	Parameter	Rating	Units
$V_{DS}$	Drain-Source Voltage	20	V
$V_{GS}$	Gate-Source Voltage	$\pm 20$	V
$I_D@T_C=25^\circ C$	Continuous Drain Current, $V_{GS} @ 10V^1$	60	A
$I_D@T_C=100^\circ C$	Continuous Drain Current, $V_{GS} @ 10V^1$	33	A
$I_{DM}$	Pulsed Drain Current <sup>2</sup>	220	A
EAS	Single Pulse Avalanche Energy <sup>3</sup>	46	mJ
$I_{AS}$	Avalanche Current	25	A
$P_D@T_C=25^\circ C$	Total Power Dissipation <sup>4</sup>	15	W
$T_{STG}$	Storage Temperature Range	-55 to 150	$^\circ C$
$T_J$	Operating Junction Temperature Range	-55 to 150	$^\circ C$

#### CST60N02D Thermal Data

Symbol	Parameter	Typ.	Max.	Unit
$R_{\theta JC}$	Thermal Resistance Junction-Case <sup>1</sup>	---	4.5	$^\circ C/W$



### CST60N02D N-Ch 20V Fast Switching MOSFETs

#### CST60N02D Electrical Characteristics (T<sub>J</sub>=25°C unless otherwise specified)

Symbol	Parameter	Test Condition	Min.	Typ.	Max.	Units
<b>Off Characteristic</b>						
V <sub>(BR)DSS</sub>	Drain-Source Breakdown Voltage	V <sub>GS</sub> =0V, I <sub>D</sub> =250μA	20	-	-	V
I <sub>DSS</sub>	Zero Gate Voltage Drain Current	V <sub>DS</sub> =20V, V <sub>GS</sub> =0V,	-	-	1.0	μA
I <sub>GSS</sub>	Gate to Body Leakage Current	V <sub>DS</sub> =0V, V <sub>GS</sub> =±12V	-	-	±100	nA
<b>On Characteristics</b>						
V <sub>GS(th)</sub>	Gate Threshold Voltage	V <sub>DS</sub> =V <sub>GS</sub> , I <sub>D</sub> =250μA	0.4	0.7	1.1	V
R <sub>DS(on)</sub>	Static Drain-Source on-Resistance note3	V <sub>GS</sub> =4.5V, I <sub>D</sub> =30A	-	4.0	5	mΩ
		V <sub>GS</sub> =2.5V, I <sub>D</sub> =20A	-	6.0	9	
<b>Dynamic Characteristics</b>						
C <sub>iss</sub>	Input Capacitance	V <sub>DS</sub> =10V, V <sub>GS</sub> =0V, f = 1.0MHz	-	2500	-	pF
C <sub>oss</sub>	Output Capacitance		-	407	-	pF
C <sub>rss</sub>	Reverse Transfer Capacitance		-	386	-	pF
Q <sub>g</sub>	Total Gate Charge	V <sub>DS</sub> =10V, I <sub>D</sub> =30A, V <sub>GS</sub> =4.5V	-	32	-	nC
Q <sub>gs</sub>	Gate-Source Charge		-	3	-	nC
Q <sub>gd</sub>	Gate-Drain("Miller") Charge		-	11	-	nC
<b>Switching Characteristics</b>						
t <sub>d(on)</sub>	Turn-on Delay Time	V <sub>DS</sub> =10V, I <sub>D</sub> =30A, R <sub>GEN</sub> =3Ω, V <sub>GS</sub> =4.5V	-	17	-	ns
t <sub>r</sub>	Turn-on Rise Time		-	49	-	ns
t <sub>d(off)</sub>	Turn-off Delay Time		-	74	-	ns
t <sub>f</sub>	Turn-off Fall Time		-	26	-	ns
<b>Drain-Source Diode Characteristics and Maximum Ratings</b>						
I <sub>S</sub>	Maximum Continuous Drain to Source Diode Forward Current		-	-	75	A
I <sub>SM</sub>	Maximum Pulsed Drain to Source Diode Forward Current		-	-	300	A
V <sub>SD</sub>	Drain to Source Diode Forward Voltage	V <sub>GS</sub> = 0V, I <sub>S</sub> =30A	-	-	1.2	V

Notes:1. Repetitive Rating: Pulse Width Limited by Maximum Junction Temperature

2. EAS condition: T<sub>J</sub>=25°C, V<sub>DD</sub>=10V, V<sub>G</sub>=4.5V, L=0.5mH, R<sub>G</sub>=25Ω, I<sub>AS</sub>=15A

3. Pulse Test: Pulse Width≤300μs, Duty Cycle≤0.5%



#### CST60N02D Typical Performance Characteristics

Figure1: Output Characteristics

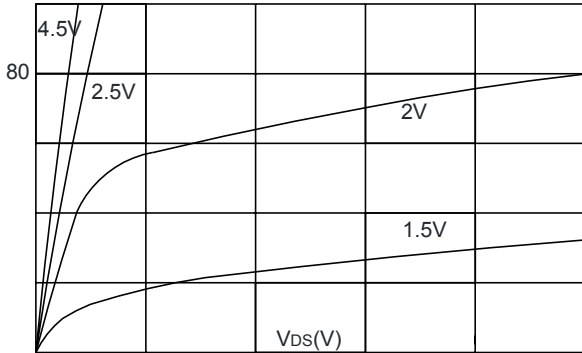
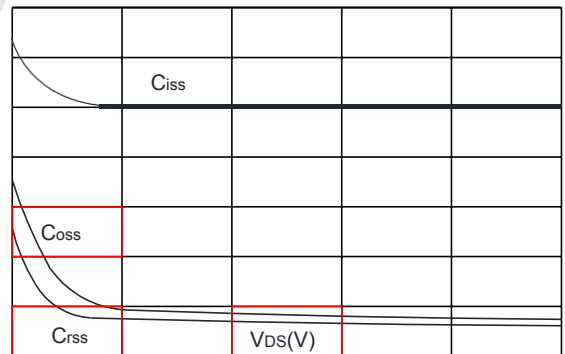
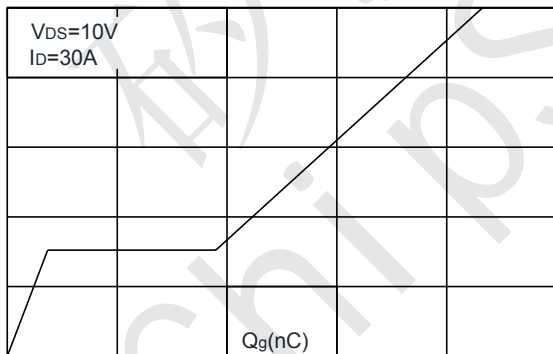
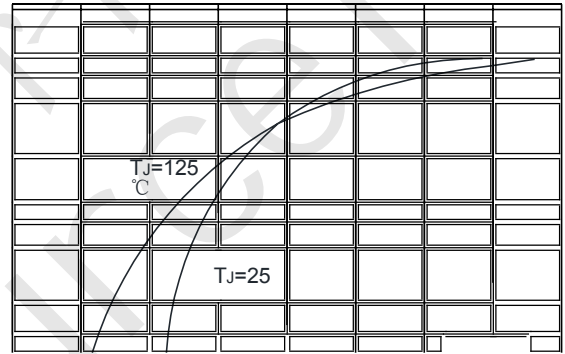
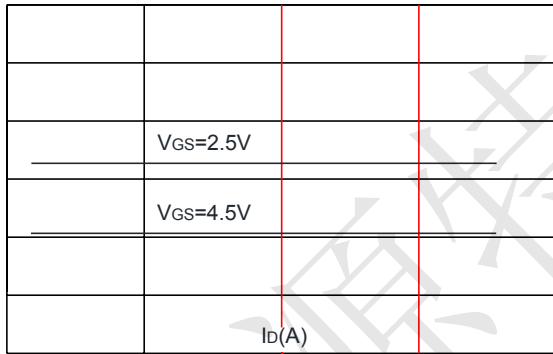
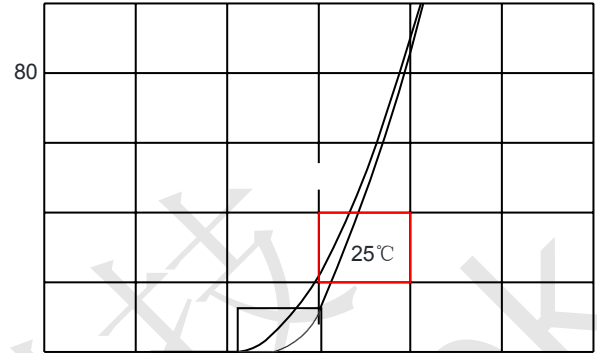


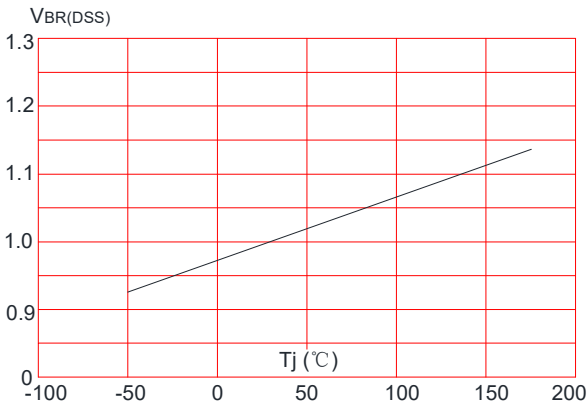
Figure 2: Typical Transfer Characteristics



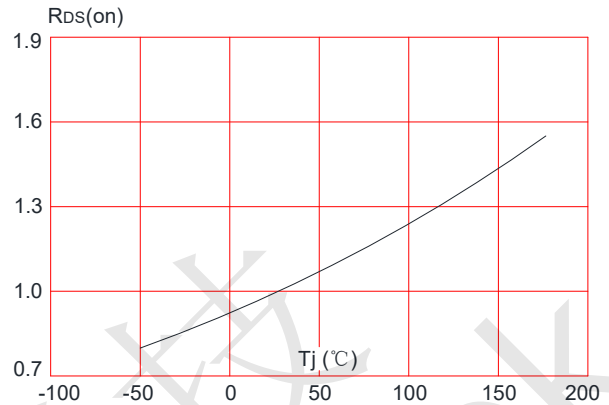


### CST60N02D N-Ch 20V Fast Switching MOSFETs

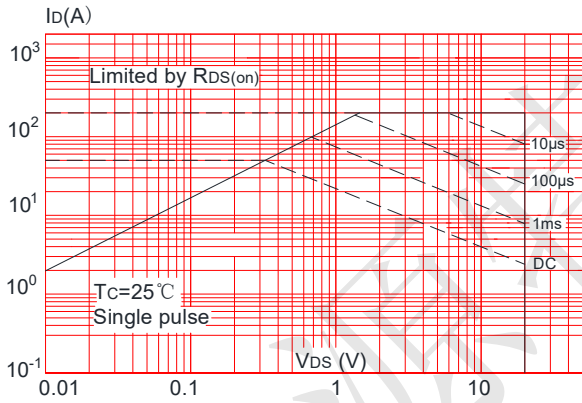
**Figure 7:** Normalized Breakdown Voltage vs. Junction Temperature



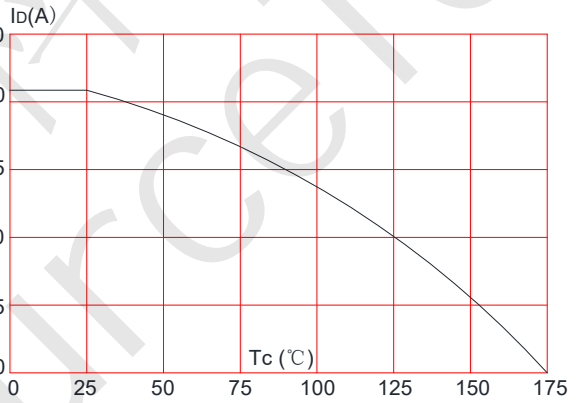
**Figure 8:** Normalized on Resistance vs. Junction Temperature



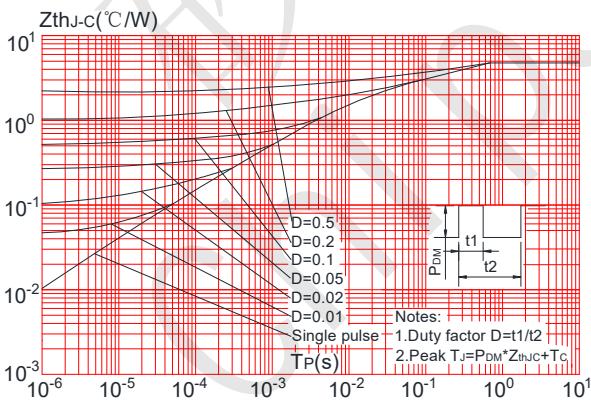
**Figure 9:** Maximum Safe Operating Area



**Figure 10:** Maximum Continuous Drain Current vs. Case Temperature

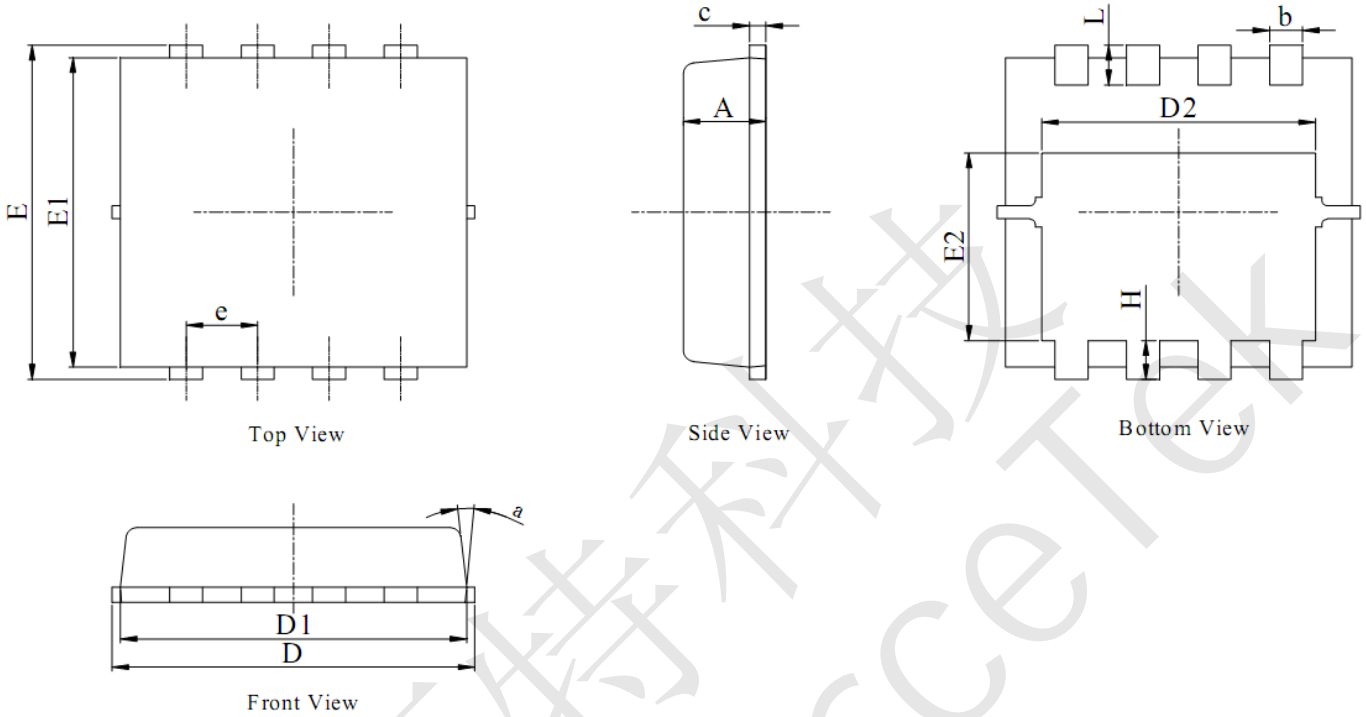


**Figure.11:** Maximum Effective Transient Thermal Impedance, Junction-to-Case





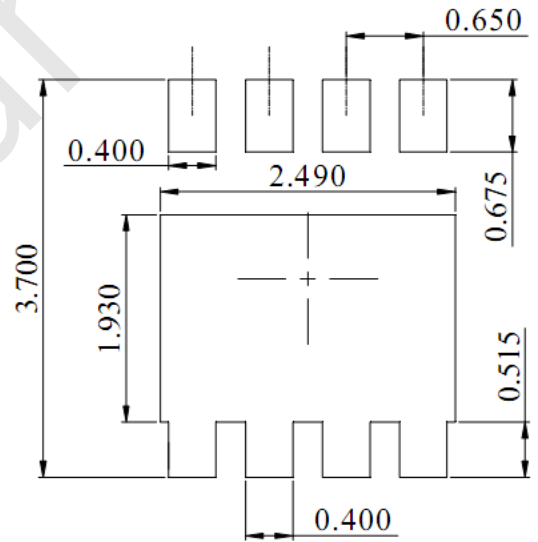
CST60N02D Package Mechanical Data-PDFN3333-8L-Single



NOTES:

1. DIMENSIONING AND TOLERANCING PER ASME Y14.5M,1994.
2. ALL DIMENSIONS IN MILLIMETER (ANNGLE IN DEGREE).
3. DIMENSIONS D1 AND E1 DO NOT INCLUDE MOLD FLASH PROTRUSIONS OR GATE BURRS.

DIM.	MILLIMETER		
	MIN.	NOM.	MAX.
A	0.70	0.75	0.80
b	0.25	0.30	0.35
c	0.10	0.20	0.25
D	3.00	3.15	3.25
D1	2.95	3.05	3.15
D2	2.39	2.49	2.59
E	3.20	3.30	3.40
E1	2.95	3.05	3.15
E2	1.70	1.80	1.90
e	0.65 BSC		
H	0.30	0.40	0.50
L	0.25	0.40	0.50
a	---	---	15°



DIMENSIONS:MILLIMETERS