



### CST4614B N-Ch and P-Ch Fast Switching MOSFETs

- ★ Green Device Available
- ★ Super Low Gate Charge
- ★ Excellent CdV/dt effect decline
- ★ Advanced high cell density Trench technology

#### CST4614B Product Summary

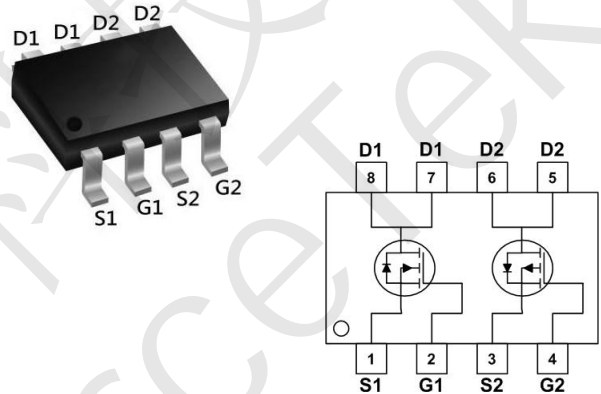


BVDSS	RDSON	ID
40V	26mΩ	7.2A
-40V	38mΩ	-7.5A

#### CST4614B Description

The CST4614B is the high performance complementary N-ch and P-ch MOSFETs with high cell density, which provide excellent RDSON and gate charge for most of the synchronous buck converter applications. The CST4614B meet the RoHS and Green Product requirement 100% EAS guaranteed with full function reliability approved.

#### CST4614B SOP8 Pin Configurations



#### CST4614B Absolute Maximum Ratings

Symbol	Parameter	Rating		Units
		N-Ch	P-Ch	
$V_{DS}$	Drain-Source Voltage	40	-40	V
$V_{GS}$	Gate-Source Voltage	$\pm 20$	$\pm 20$	V
$I_D@T_C=25^\circ C$	Continuous Drain Current, $V_{GS} @ 10V^1$	7.2	-7.5	A
$I_D@T_C=100^\circ C$	Continuous Drain Current, $V_{GS} @ 10V^1$	5.6	-5.1	A
$I_{DM}$	Pulsed Drain Current <sup>2</sup>	14.5	-13	A
EAS	Single Pulse Avalanche Energy <sup>3</sup>	28	66	mJ
$I_{AS}$	Avalanche Current	17.8	-27.2	A
$P_D@T_C=25^\circ C$	Total Power Dissipation <sup>4</sup>	2.5	3.1	W
$T_{STG}$	Storage Temperature Range	-55 to 150	-55 to 150	$^\circ C$
$T_J$	Operating Junction Temperature Range	-55 to 150	-55 to 150	$^\circ C$



### CST4614B N-Ch and P-Ch Fast Switching MOSFETs

#### CST4614B Electrical Characteristics (T<sub>J</sub>=25°C unless otherwise specified)

Symbol	Parameter	Test Condition	Min.	Typ.	Max.	Units
<b>Off Characteristic</b>						
V <sub>(BR)DSS</sub>	Drain-Source Breakdown Voltage	V <sub>GS</sub> =0V, I <sub>D</sub> =250μA	40	-	-	V
I <sub>DSS</sub>	Zero Gate Voltage Drain Current	V <sub>DS</sub> =40V, V <sub>GS</sub> =0V,	-	-	1.0	μA
I <sub>GSS</sub>	Gate to Body Leakage Current	V <sub>DS</sub> =0V, V <sub>GS</sub> =±20V	-	-	±100	nA
<b>On Characteristics</b>						
V <sub>GS(th)</sub>	Gate Threshold Voltage	V <sub>DS</sub> =V <sub>GS</sub> , I <sub>D</sub> =250μA	1.0	1.5	2.5	V
R <sub>DS(on)</sub>	Static Drain-Source on-Resistance <small>note3</small>	V <sub>GS</sub> =10V, I <sub>D</sub> =4A	-	26	40	mΩ
		V <sub>GS</sub> =4.5V, I <sub>D</sub> =3A	-	35	60	
<b>Dynamic Characteristics</b>						
C <sub>iss</sub>	Input Capacitance	V <sub>DS</sub> =20V, V <sub>GS</sub> =0V, f=1.0MHz	-	435	-	pF
C <sub>oss</sub>	Output Capacitance		-	58	-	pF
C <sub>rss</sub>	Reverse Transfer Capacitance		-	35	-	pF
Q <sub>g</sub>	Total Gate Charge	V <sub>DS</sub> =20V, I <sub>D</sub> =3A, V <sub>GS</sub> =10V	-	11	-	nC
Q <sub>gs</sub>	Gate-Source Charge		-	2	-	nC
Q <sub>gd</sub>	Gate-Drain("Miller") Charge		-	2.5	-	nC
<b>Switching Characteristics</b>						
t <sub>d(on)</sub>	Turn-on Delay Time	V <sub>DD</sub> =20V, I <sub>D</sub> =4A, R <sub>L</sub> =1Ω, R <sub>GEN</sub> =3Ω, V <sub>GS</sub> =10V	-	10	-	ns
t <sub>r</sub>	Turn-on Rise Time		-	8	-	ns
t <sub>d(off)</sub>	Turn-off Delay Time		-	29	-	ns
t <sub>f</sub>	Turn-off Fall Time		-	12	-	ns
<b>Drain-Source Diode Characteristics and Maximum Ratings</b>						
I <sub>S</sub>	Maximum Continuous Drain to Source Diode Forward Current		-	-	7.2	A
I <sub>SM</sub>	Maximum Pulsed Drain to Source Diode Forward Current		-	-	20	A
V <sub>SD</sub>	Drain to Source Diode Forward Voltage	V <sub>GS</sub> =0V, I <sub>S</sub> =5A	-	-	1.2	V
t <sub>rr</sub>	Body Diode Reverse Recovery Time	T <sub>J</sub> =25°C, I <sub>F</sub> =5A, di/dt=100A/μs	-	20	-	ns
Q <sub>rr</sub>	Body Diode Reverse Recovery Charge		-	11	-	nC

Notes:1. Repetitive Rating: Pulse Width Limited by Maximum Junction Temperature

2. Pulse Test: Pulse Width≤300μs, Duty Cycle≤0.5%



### CST4614B N-Ch and P-Ch Fast Switching MOSFETs

#### CST4614B P-Channel Electrical Characteristics (T<sub>J</sub>=25°C unless otherwise specified)

Symbol	Parameter	Test Condition	Min.	Typ.	Max.	Units
<b>Off Characteristic</b>						
V <sub>(BR)DSS</sub>	Drain-Source Breakdown Voltage	V <sub>GS</sub> =0V, I <sub>D</sub> = -250μA	-40	-	-	V
I <sub>DSS</sub>	Zero Gate Voltage Drain Current	V <sub>DS</sub> = -40V, V <sub>GS</sub> =0V	-	-	-1	μA
I <sub>GSS</sub>	Gate to Body Leakage Current	V <sub>DS</sub> =0V, V <sub>GS</sub> =±20V	-	-	±100	nA
<b>On Characteristics</b>						
V <sub>GS(th)</sub>	Gate Threshold Voltage	V <sub>DS</sub> =V <sub>GS</sub> , I <sub>D</sub> = -250μA	-1.0	-1.6	-2.5	V
R <sub>DS(on)</sub>	Static Drain-Source on-Resistance <small>note3</small>	V <sub>GS</sub> = -10V, I <sub>D</sub> = -6A	-	38	53	mΩ
		V <sub>GS</sub> = -4.5V, I <sub>D</sub> = -4A	-	58	81	
<b>Dynamic Characteristics</b>						
C <sub>iss</sub>	Input Capacitance	V <sub>DS</sub> = -20V, V <sub>GS</sub> =0V, f=1.0MHz	-	860	-	pF
C <sub>oss</sub>	Output Capacitance		-	87	-	pF
C <sub>rss</sub>	Reverse Transfer Capacitance		-	70	-	pF
Q <sub>g</sub>	Total Gate Charge	V <sub>DS</sub> = -20V, I <sub>D</sub> = -6A, V <sub>GS</sub> = -10V	-	13	-	nC
Q <sub>gs</sub>	Gate-Source Charge		-	3.8	-	nC
Q <sub>gd</sub>	Gate-Drain("Miller") Charge		-	3.1	-	nC
<b>Switching Characteristics</b>						
t <sub>d(on)</sub>	Turn-on Delay Time	V <sub>DD</sub> = -20V, R <sub>L</sub> =2.3Ω V <sub>GS</sub> =-10V, R <sub>REN</sub> =6Ω	-	7.5	-	ns
t <sub>r</sub>	Turn-on Rise Time		-	5.5	-	ns
t <sub>d(off)</sub>	Turn-off Delay Time		-	19	-	ns
t <sub>f</sub>	Turn-off Fall Time		-	7	-	ns
<b>Drain-Source Diode Characteristics and Maximum Ratings</b>						
I <sub>S</sub>	Maximum Continuous Drain to Source Diode Forward Current		-	-	-7.5	A
I <sub>SM</sub>	Maximum Pulsed Drain to Source Diode Forward Current		-	-	-24	A
V <sub>SD</sub>	Drain to Source Diode Forward Voltage	V <sub>GS</sub> =0V, I <sub>S</sub> = -6A	-	-	-1.2	V



### CST4614B Typical Performance Characteristics-N

Figure 1: Output Characteristics

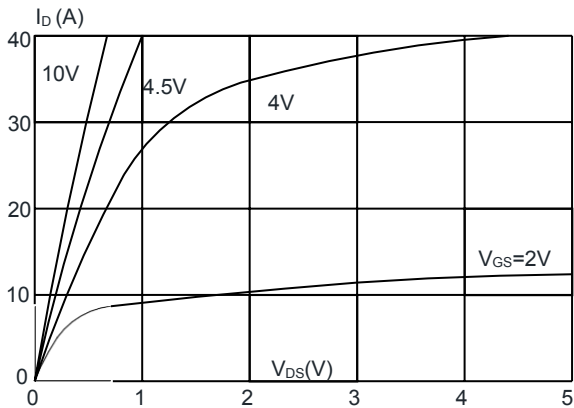


Figure 2: Typical Transfer Characteristics

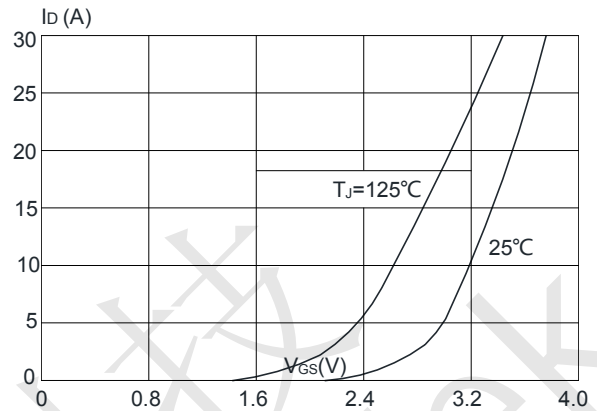


Figure 3: On-resistance vs. Drain Current

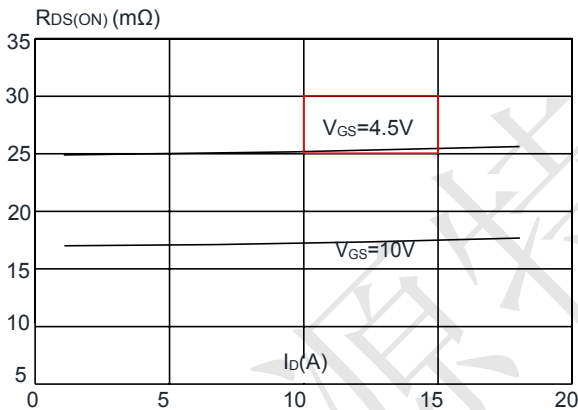


Figure 4: Body Diode Characteristics

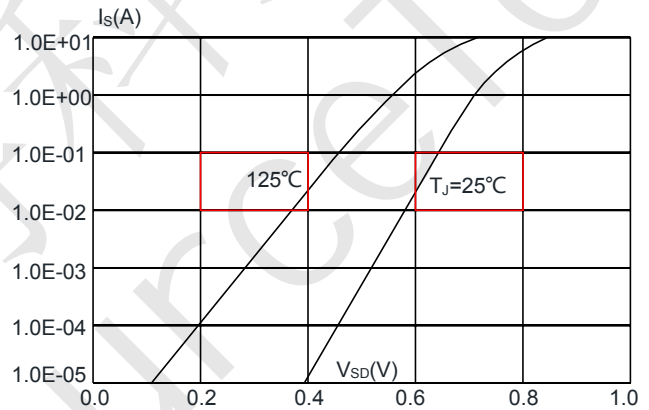


Figure 5: Gate Charge Characteristics

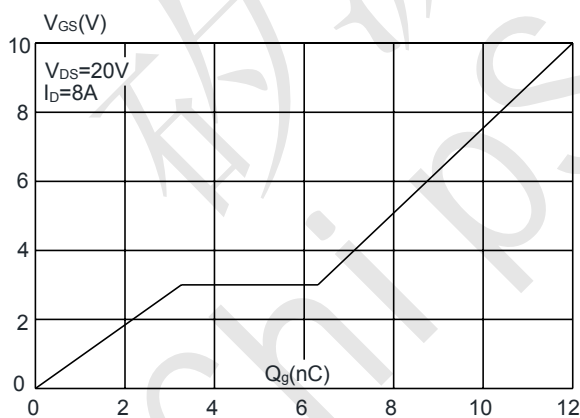
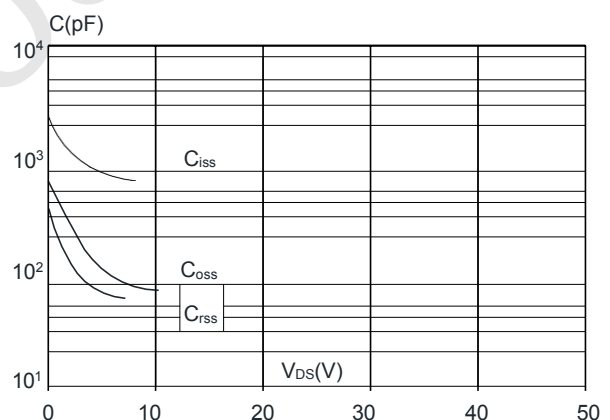


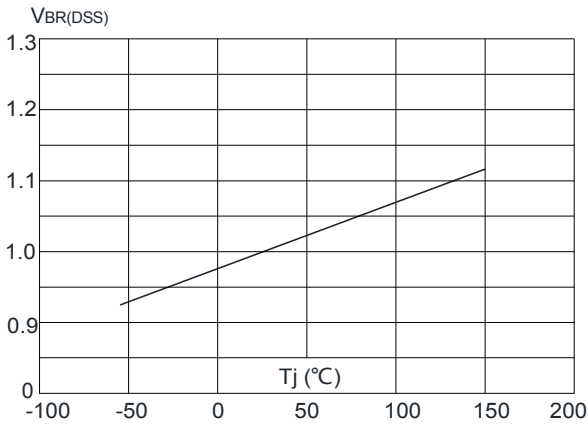
Figure 6: Capacitance Characteristics



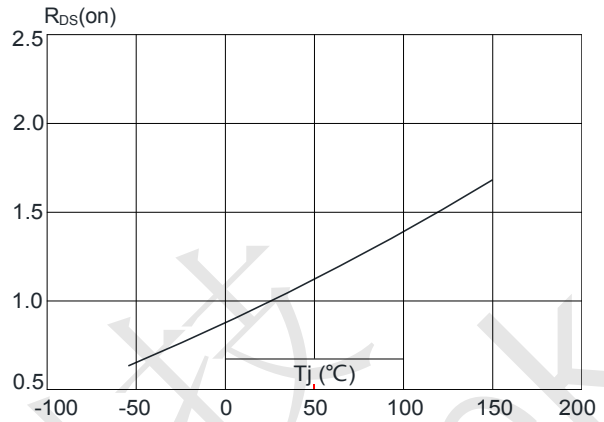


### CST4614B N-Ch and P-Ch Fast Switching MOSFETs

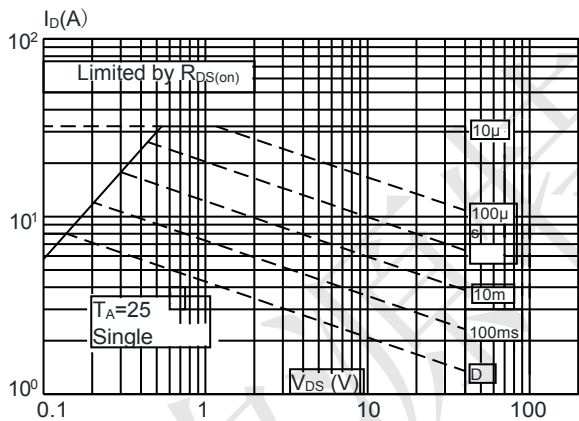
**Figure 7:** Normalized Breakdown Voltage vs. Junction Temperature



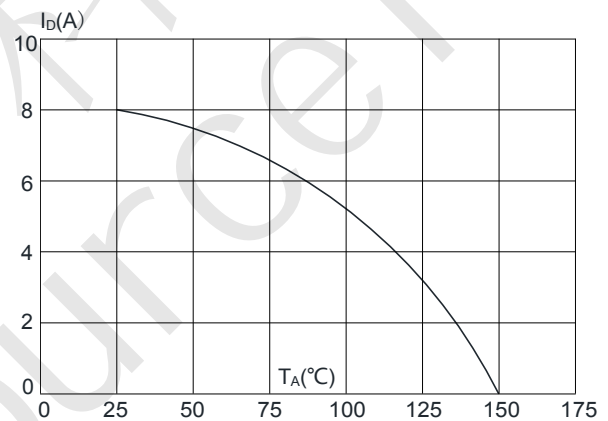
**Figure 8:** Normalized on Resistance vs. Junction Temperature



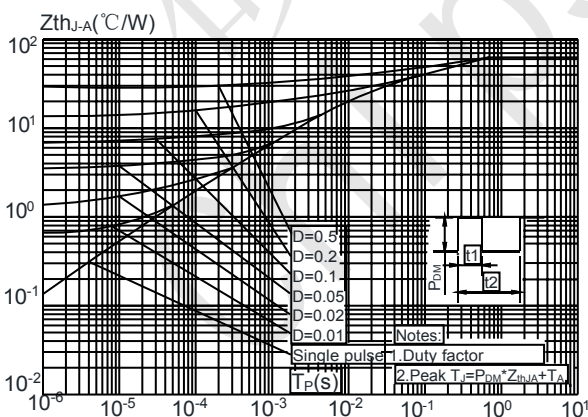
**Figure 9:** Maximum Safe Operating Area



**Figure 10:** Maximum Continuous Drain Current vs. Ambient Temperature



**Figure.11:** Maximum Effective Transient Thermal Impedance, Junction-to-Ambient





### CST4614B Typical Performance Characteristics-P

Figure 1: Output Characteristics

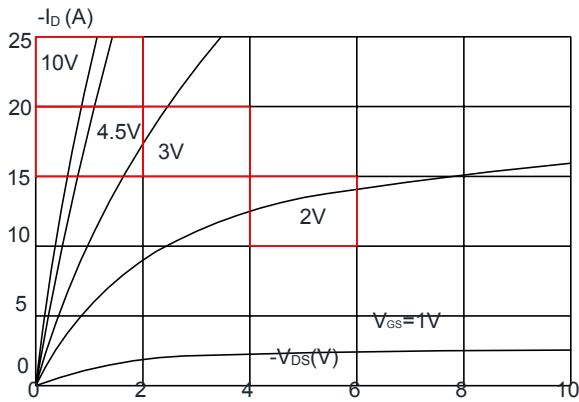


Figure 2: Typical Transfer Characteristics

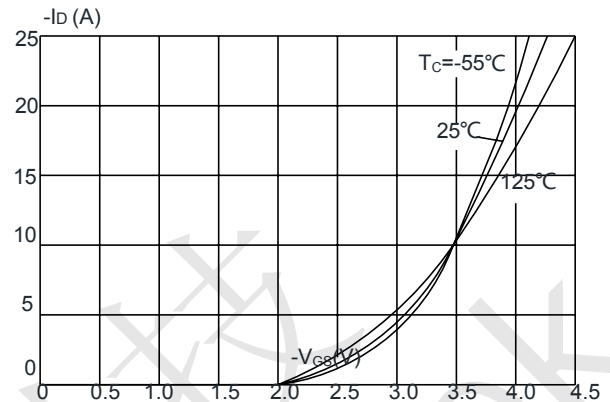


Figure 3: On-resistance vs. Drain Current

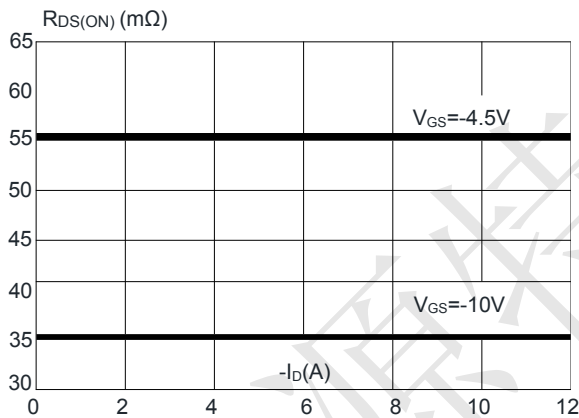


Figure 4: Body Diode Characteristics

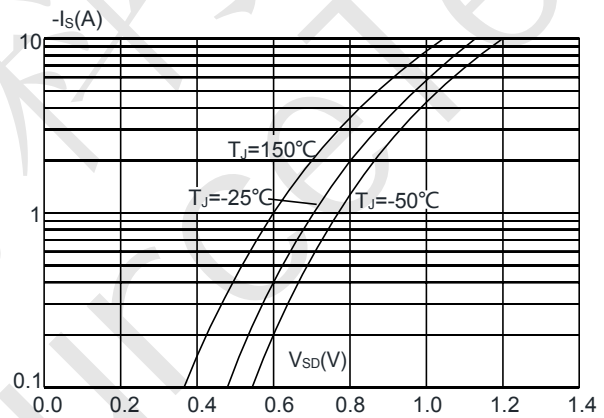


Figure 5: Gate Charge Characteristics

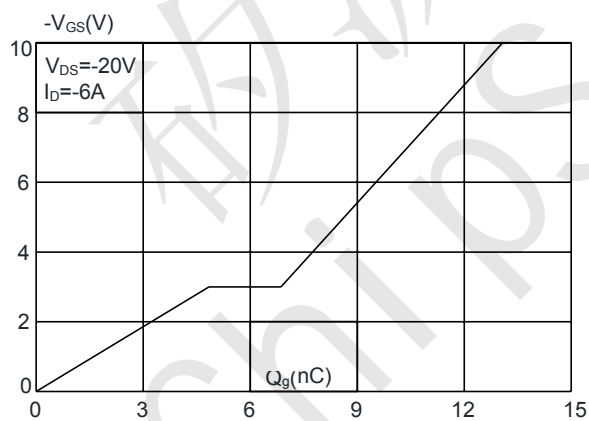
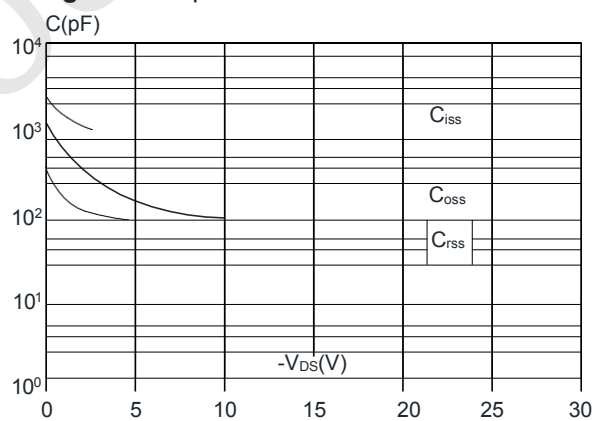


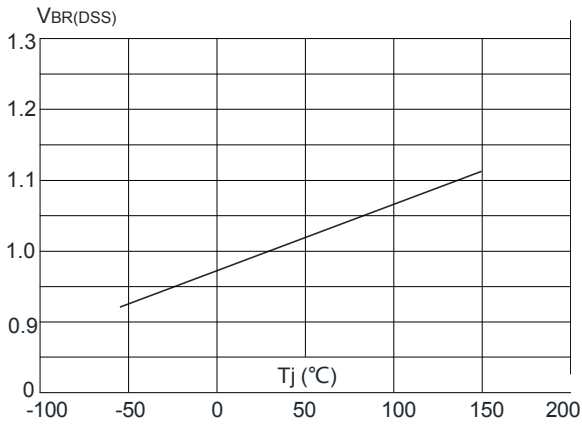
Figure 6: Capacitance Characteristics



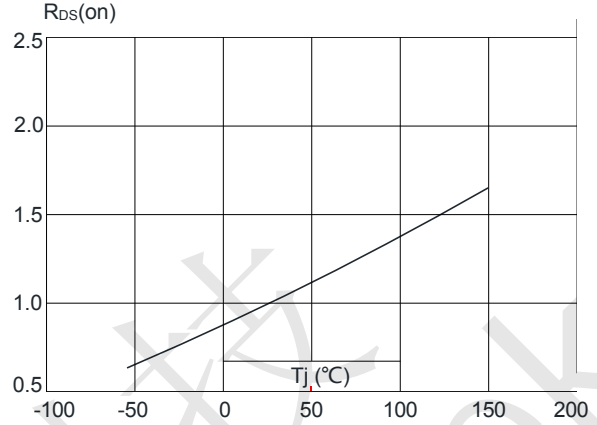


### CST4614B N-Ch and P-Ch Fast Switching MOSFETs

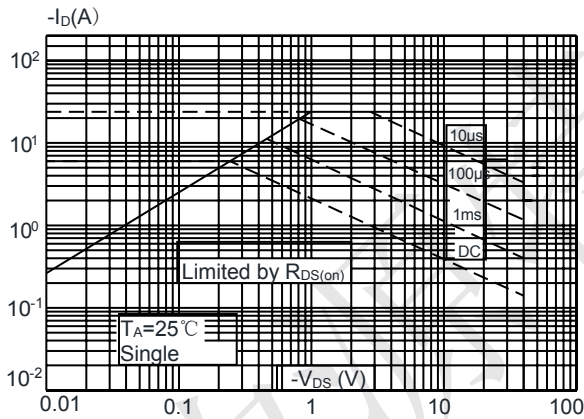
**Figure 7:** Normalized Breakdown Voltage vs. Junction Temperature



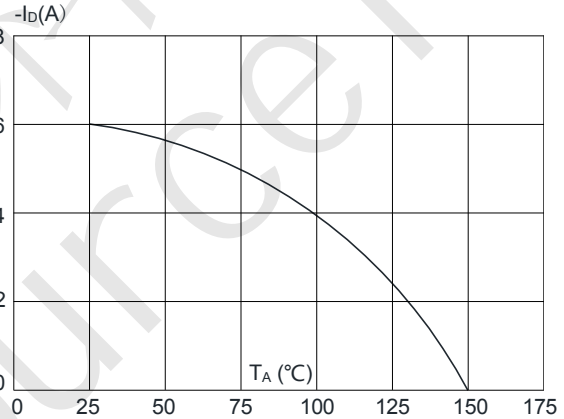
**Figure 8:** Normalized on Resistance vs. Junction Temperature



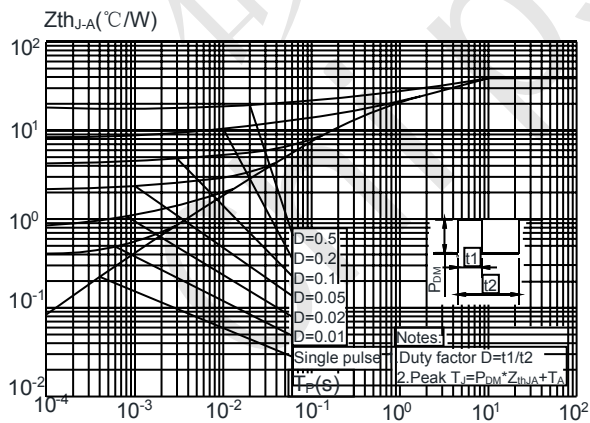
**Figure 9:** Maximum Safe Operating Area



**Figure 10:** Maximum Continuous Drain Current vs. Ambient Temperature

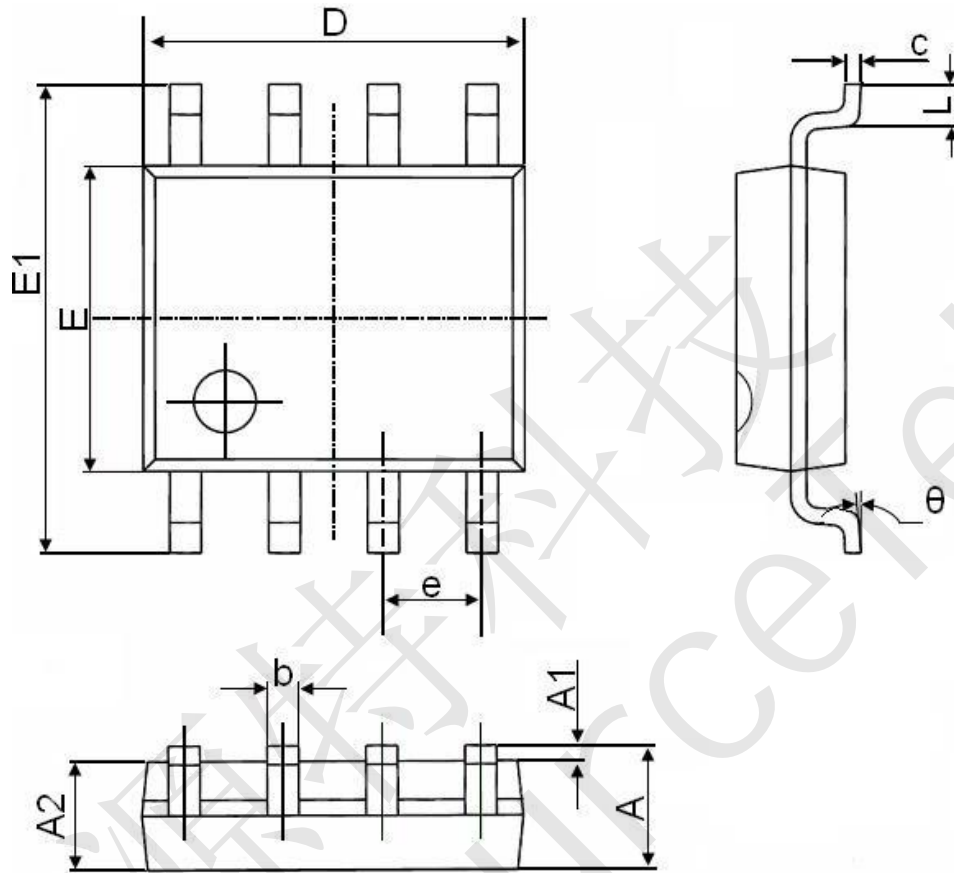


**Figure.11:** Maximum Effective Transient Thermal Impedance, Junction-to-Ambient





CST4614B SOP-8 Package Information



Symbol	Dimensions In Millimeters		Dimensions In Inches	
	Min.	Max.	Min.	Max.
A	1.350	1.750	0.053	0.069
A1	0.100	0.250	0.004	0.010
A2	1.350	1.550	0.053	0.061
b	0.330	0.510	0.013	0.020
c	0.170	0.250	0.006	0.010
D	4.700	5.100	0.185	0.200
E	3.800	4.000	0.150	0.157
E1	5.800	6.200	0.228	0.244
e	1.270(BSC)		0.050(BSC)	
L	0.400	1.270	0.016	0.050
θ	0°	8°	0°	8°