



CST4485 P-Ch 40V Fast Switching MOSFETs

- ★ 100% EAS Guaranteed
- ★ Green Device Available
- ★ Super Low Gate Charge
- ★ Excellent CdV/dt effect decline
- ★ Advanced high cell density Trench technology

CST4485 Product Summary



BVDSS	RDSON	ID
-40V	14 mΩ	-13 A

CST4485 General Description

The CST4485 is the high cell density trenched P-ch MOSFETs, which provide excellent RDSON and gate charge for most of the synchronous buck converter applications.

The CST4485 meet the RoHS and Green Product requirement, 100% EAS guaranteed with full function reliability approved.

CST4485 SOP8 Pin Configuration

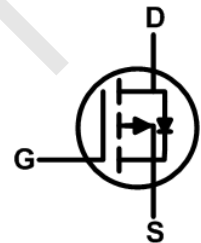
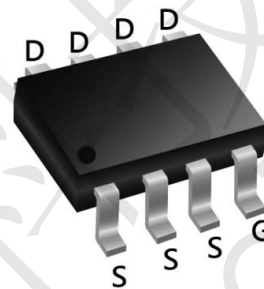

CST4485 Absolute Maximum Ratings (TA= 25°C, unless otherwise noted)

Parameter	Symbol	Value	Unit
Drain-Source Voltage	V _{DS}	-40	V
Gate-Source Voltage	V _{GS}	±20	V
Continuous Drain Current	I _D	TA=25°C	-13
		TA=100°C	-8.5
Pulsed Drain Current ¹	I _{DM}	-52	A
Single Pulse Avalanche Energy ²	EAS	80	mJ
Total Power Dissipation	P _D	3	W
Operating Junction and Storage Temperature Range	T _J , T _{STG}	-55 to 150	°C

CST4485 Thermal Characteristics

Parameter	Symbol	Value	Unit
Thermal Resistance from Junction-to-Ambient ³	R _{θJA}	41	°C/W



CST4485 P-Ch 40V Fast Switching MOSFETs

CST4485 Electrical Characteristics ($T_J = 25^\circ\text{C}$, unless otherwise noted)

Parameter	Symbol	Test Conditions	Min.	Typ.	Max.	Unit	
Static Characteristics							
Drain-Source Breakdown Voltage	$V_{(BR)DSS}$	$V_{GS} = 0V, I_D = -250\mu A$	-40	-	-	V	
Gate-body Leakage current	I_{GSS}	$V_{DS} = 0V, V_{GS} = \pm 20V$	-	-	± 100	nA	
Zero Gate Voltage Drain Current	I_{DSS}	$V_{DS} = -40V, V_{GS} = 0V$	$T_J = 25^\circ\text{C}$	-	-	-1	μA
			$T_J = 100^\circ\text{C}$	-	-	-100	
Gate-Threshold Voltage	$V_{GS(th)}$	$V_{DS} = V_{GS}, I_D = -250\mu A$	-1.0	-1.5	-2.2	V	
Drain-Source On-Resistance ⁴	$R_{DS(on)}$	$V_{GS} = -10V, I_D = -10A$	-	14.0	19	m Ω	
		$V_{GS} = -4.5V, I_D = -5 A$	-	19.5	25		
Forward Transconductance ⁴	g_{fs}	$V_{DS} = -10V, I_D = -10A$	-	44	-	S	
Dynamic Characteristics⁵							
Input Capacitance	C_{iss}	$V_{DS} = -20V, V_{GS} = 0V, f = 1MHz$	-	2525	-	pF	
Output Capacitance	C_{oss}		-	190	-		
Reverse Transfer Capacitance	C_{rss}		-	172	-		
Gate Resistance	R_g	$f = 1MHz$	-	10	-	Ω	
Switching Characteristics⁵							
Total Gate Charge	Q_g	$V_{GS} = -10V, V_{DS} = -20V, I_D = -10A$	-	35	-	nC	
Gate-Source Charge	Q_{gs}		-	5.5	-		
Gate-Drain Charge	Q_{gd}		-	8	-		
Turn-On Delay Time	$t_{d(on)}$	$V_{GS} = -10V, V_{DD} = -20V, R_G = 3\Omega, I_D = -10A$	-	14.5	-	ns	
Rise Time	t_r		-	20.2	-		
Turn-Off Delay Time	$t_{d(off)}$		-	32	-		
Fall Time	t_f		-	10	-		
Drain-Source Body Diode Characteristics							
Diode Forward Voltage ⁴	V_{SD}	$I_S = -10A, V_{GS} = 0V$	-	-	-1.2	V	
Continuous Source Current	I_S	$T_C = 25^\circ\text{C}$	-	-	-13	A	

Note :

1. Repetitive rating, pulse width limited by junction temperature $T_{J(MAX)} = 150^\circ\text{C}$.
2. The EAS data shows Max. rating . The test condition is $V_{DD} = -25V, V_{GS} = -10V, L = 0.1mH, I_{AS} = -34A$.
3. The data tested by surface mounted on a 1 inch² FR-4 board with 20Z copper, The value in any given application depends on the user's specific board design.
4. The data tested by pulsed , pulse width $\leq 300\mu s$, duty cycle $\leq 2\%$.
5. This value is guaranteed by design hence it is not included in the production test.



CST4485 Typical Characteristics

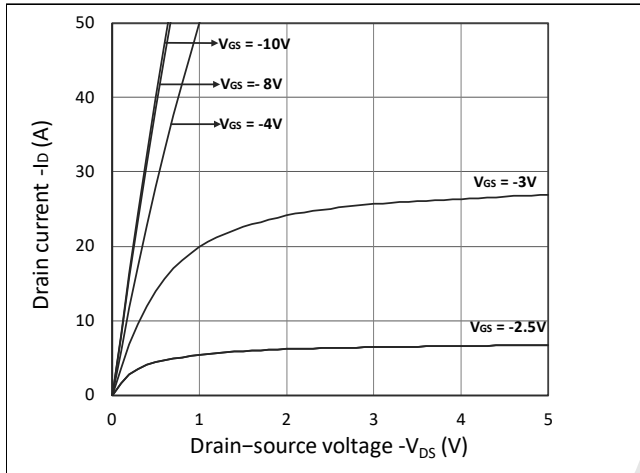

Figure 1. Output Characteristics

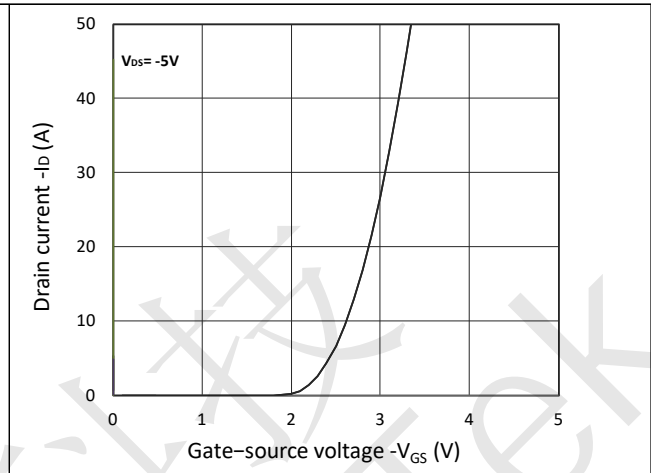

Figure 2. Transfer Characteristics

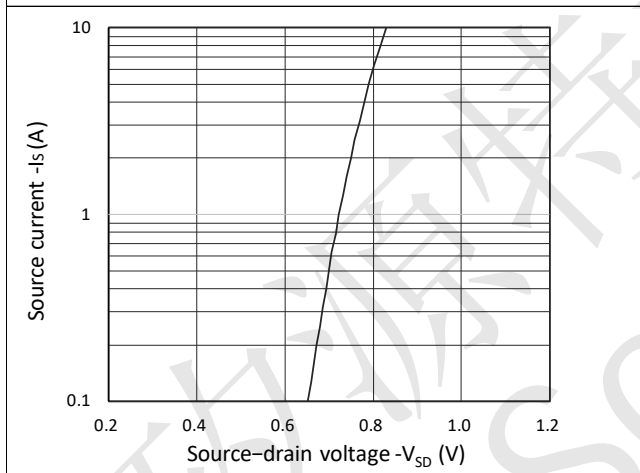

Figure 3. Forward Characteristics of Reverse

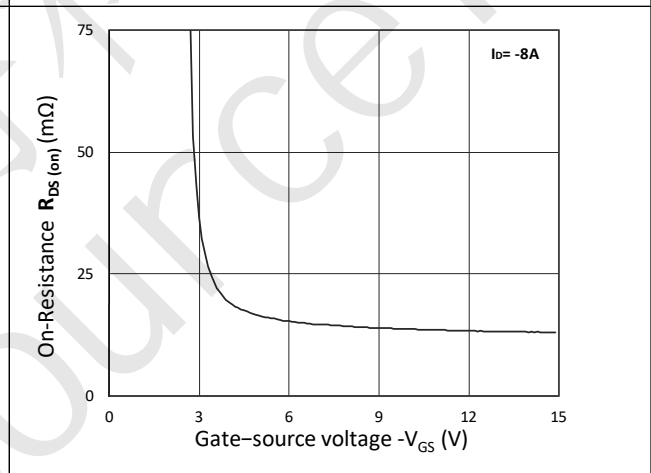

Figure 4. $R_{DS(ON)}$ vs. V_{GS}

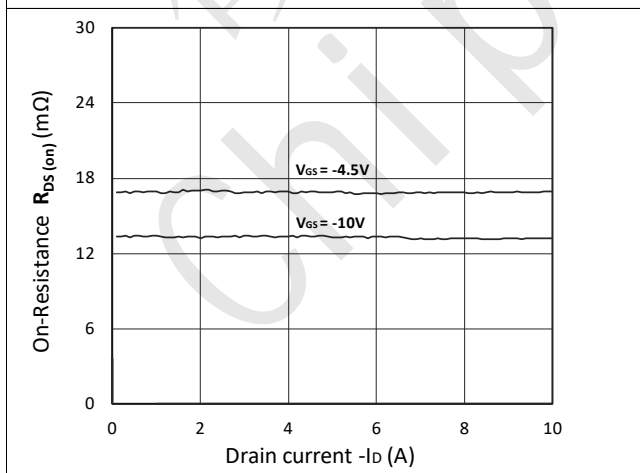

Figure 5. $R_{DS(ON)}$ vs. I_D

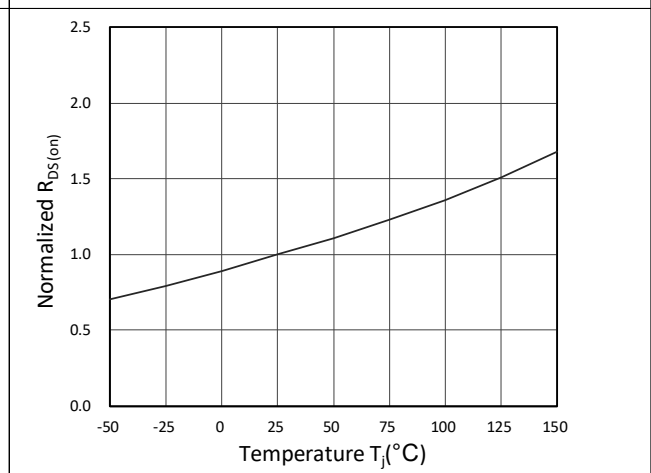

Figure 6. Normalized $R_{DS(on)}$ vs. Temperature



CST4485 P-Ch 40V Fast Switching MOSFETs

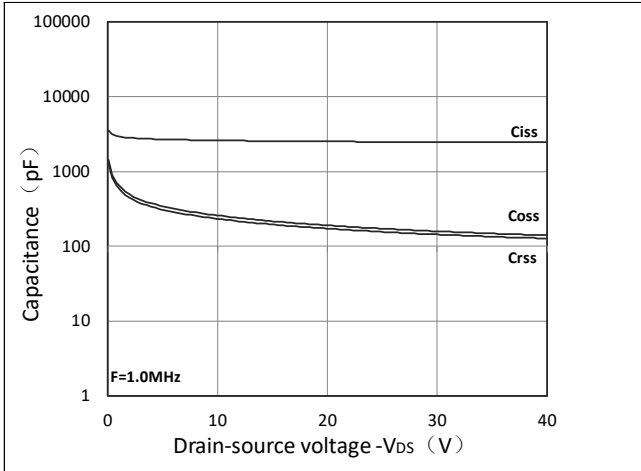

Figure 7. Capacitance Characteristics

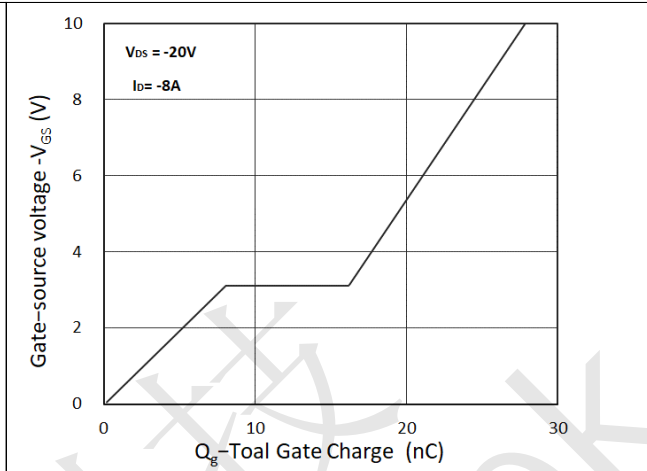

Figure 8. Gate Charge Characteristics

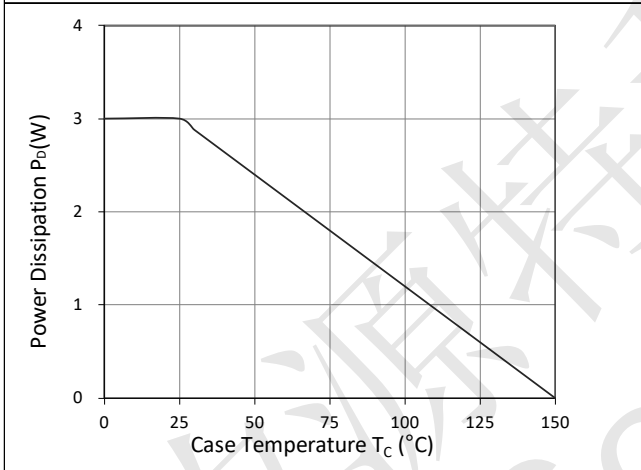

Figure 9. Power Dissipation

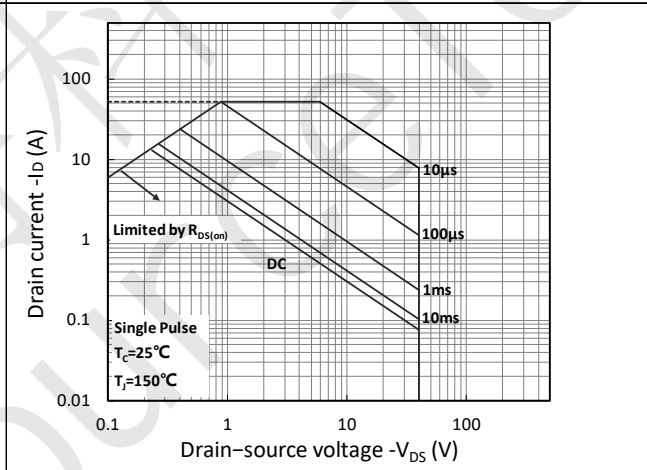

Figure 10. Safe Operating Area

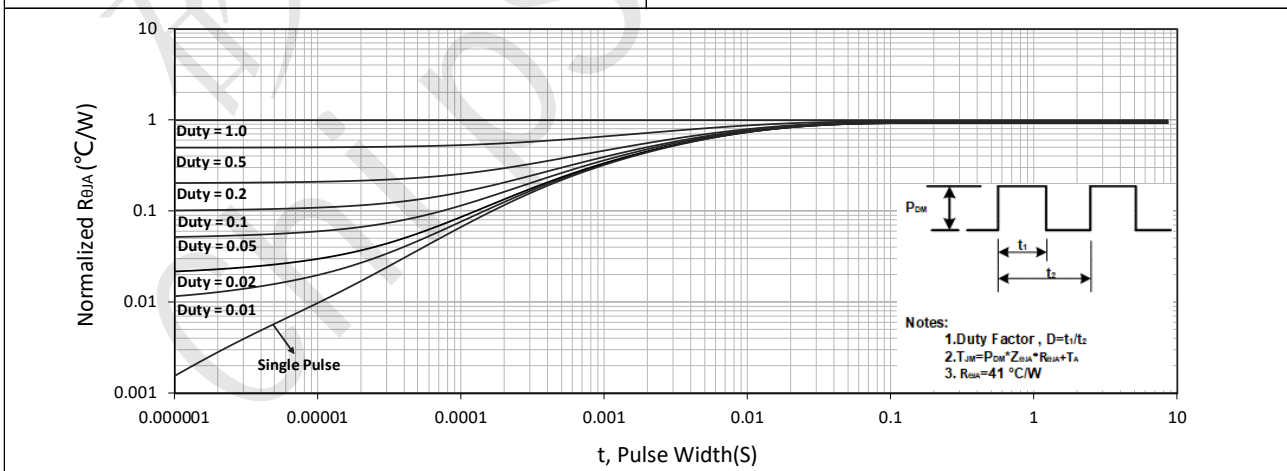
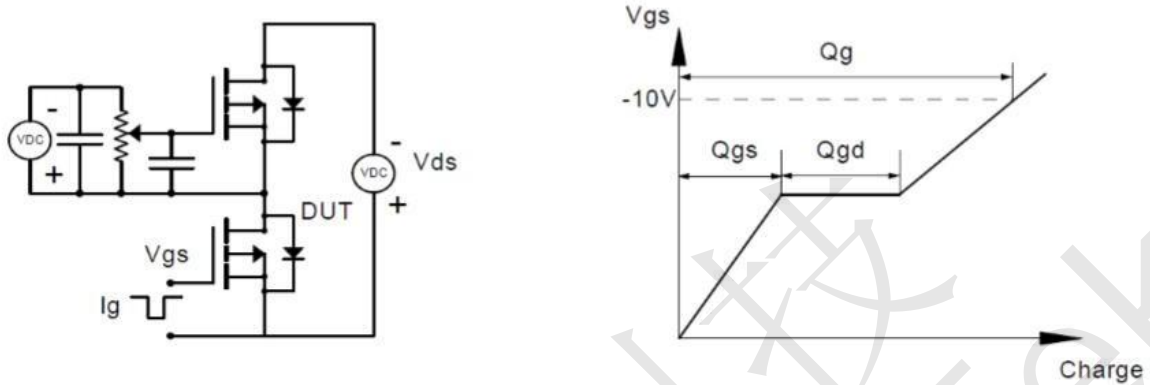

Figure 11. Normalized Maximum Transient Thermal Impedance



CST4485 Test Circuit

Gate Charge Test Circuit & Waveform



Resistive Switching Test Circuit & Waveforms

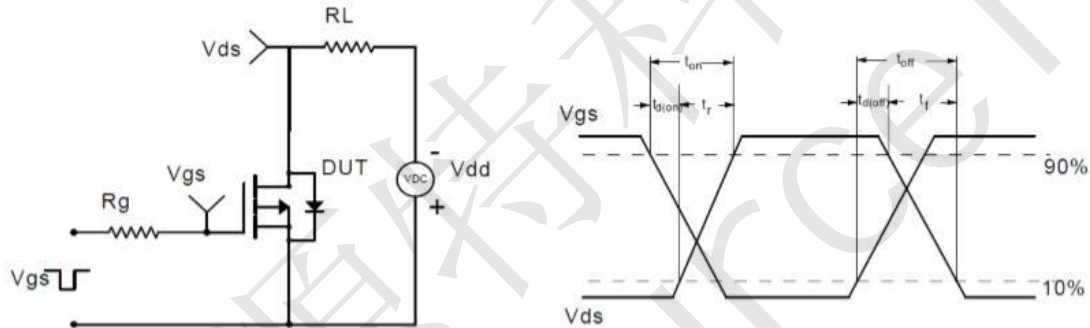

Unclamped Inductive Switching (UIS) Test Circuit & Waveforms

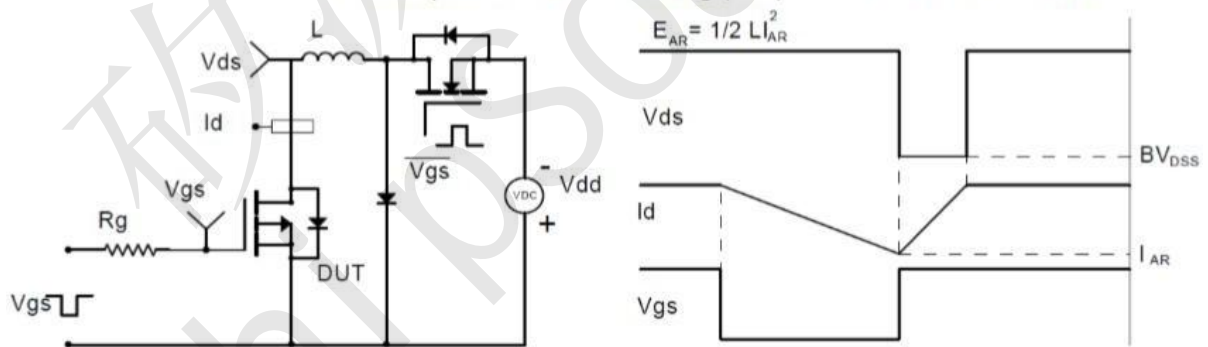

Diode Recovery Test Circuit & Waveforms

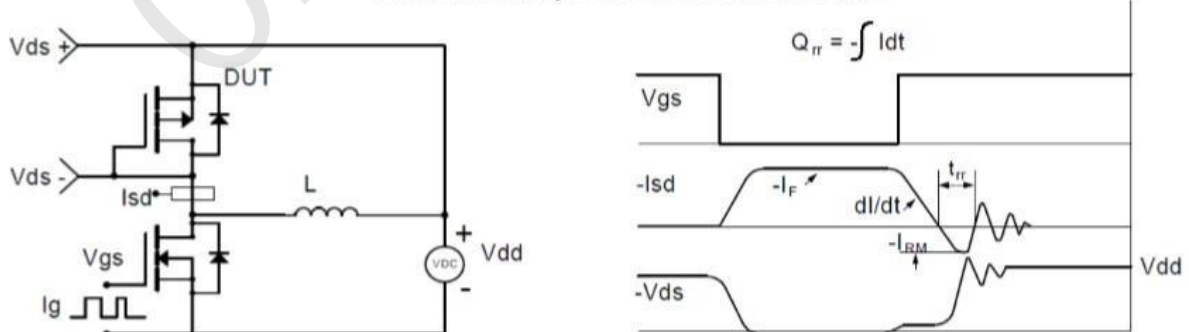



CST4485 SOP-8 Package Information

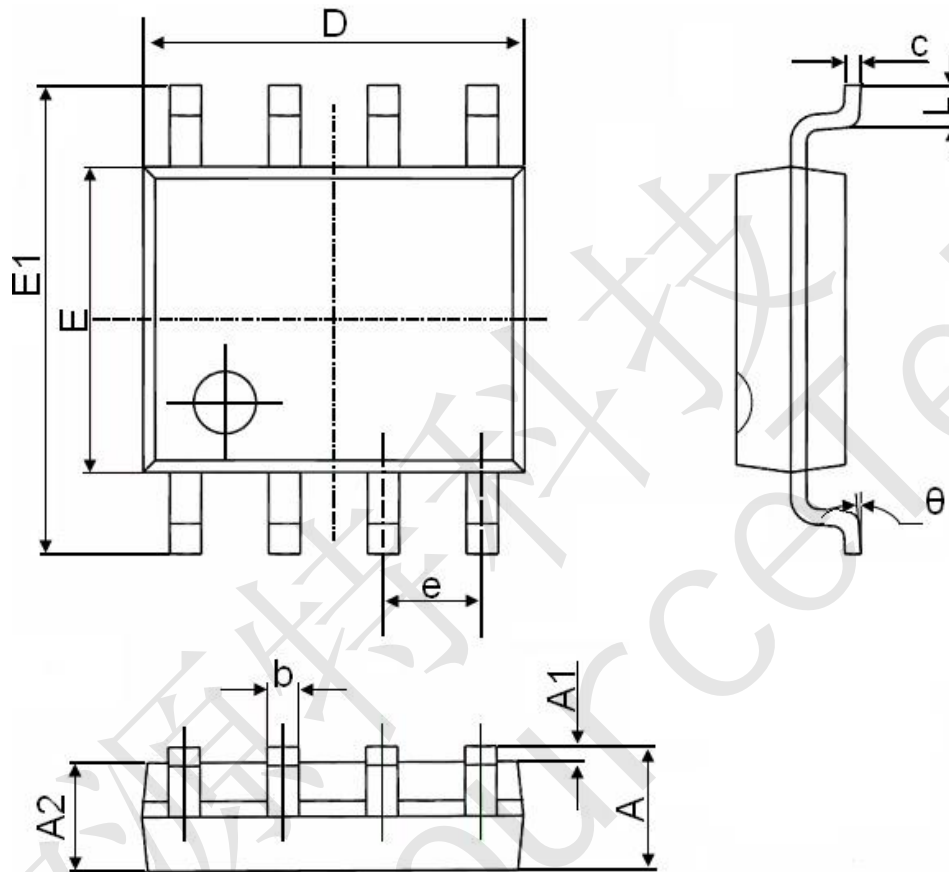

Symbol	Dimensions In Millimeters		Dimensions In Inches	
	Min.	Max.	Min.	Max.
A	1.350	1.750	0.053	0.069
A1	0.100	0.250	0.004	0.010
A2	1.350	1.550	0.053	0.061
b	0.330	0.510	0.013	0.020
c	0.170	0.250	0.006	0.010
D	4.700	5.100	0.185	0.200
E	3.800	4.000	0.150	0.157
E1	5.800	6.200	0.228	0.244
e	1.270(BSC)		0.050(BSC)	
L	0.400	1.270	0.016	0.050
θ	0°	8°	0°	8°