



CST2319 P-Ch 40V Fast Switching MOSFETs

- ★ Green Device Available
- ★ Super Low Gate Charge
- ★ Excellent CdV/dt effect decline
- ★ Advanced high cell density Trench technology

CST2319 Product Summary



BVDSS	RDSON	ID
-40V	63mΩ	-4 A

CST2319 Description

The CST2319 is the high cell density trenched N-ch MOSFETs, which provides excellent RDSON and efficiency for most of the small power switching and load switch applications. The CST2319 meet the RoHS and Green Product requirement with full function reliability approved.

CST2319 SOT 23 Pin Configurations

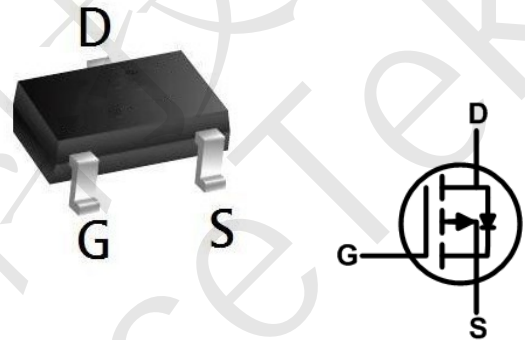

CST2319 Absolute Maximum Rating ($T_A=25^{\circ}\text{C}$ unless otherwise noted)

Parameter	Symbol	Value	Units
Drain-Source Voltage	V_{DS}	-40	V
Gate-Source Voltage	V_{GS}	± 20	V
Continuous Drain Current	I_D	-4	A
	$T_A = 25^{\circ}\text{C}$		
Pulsed Drain Current ¹	I_{DM}	-20	A
Power Dissipation	P_D	1.2	W
	$T_A = 25^{\circ}\text{C}$		
Operating Junction and Storage Temperature Range	T_J, T_{STG}	-55 to 150	$^{\circ}\text{C}$

CST2319 Thermal Characteristics

Parameter	Symbol	Value	Units
Thermal Resistance from Junction to Ambient ²	$R_{\theta JA}$	104	$^{\circ}\text{C/W}$



CST2319 P-Ch 40V Fast Switching MOSFETs

CST2319 Electrical Characteristics (T_J=25°C unless otherwise noted)

Parameter	Symbol	Conditions	Min.	Typ.	Max.	Units
Static Characteristics						
Drain-Source Breakdown Voltage	V _{(BR)DSS}	V _{GS} = 0V, I _D = -250μA	-40	-	-	V
Zero Gate Voltage Drain Current	I _{DSS}	V _{DS} = -40V, V _{GS} = 0V	-	-	-1	μA
Gate-Body Leakage	I _{GSS}	V _{DS} = 0V, V _{GS} = ±20V	-	-	±100	nA
Gate-Threshold Voltage	V _{GS(th)}	V _{DS} = V _{GS} , I _D = -250μA	-1.2	-1.5	-2.5	V
Drain-Source on-Resistance ³	R _{DS(on)}	V _{GS} = -10V, I _D = -5A	-	63	85	mΩ
		V _{GS} = -4.5V, I _D = -4A	-	80	125	
Dynamic Characteristics⁴						
Input Capacitance	C _{iss}	V _{GS} = 0V, V _{DS} = -20V, f=1.0MHz	-	553	-	pF
Output Capacitance	C _{oss}		-	50	-	
Reverse Transfer Capacitance	C _{rss}		-	42	-	
Switching Characteristics⁴						
Total Gate Charge	Q _g	V _{GS} = -10V, V _{DS} = -20V, I _D = -5A	-	11.8	-	nC
Gate-Source Charge	Q _{gs}		-	2.2	-	
Gate-Drain Charge	Q _{gd}		-	3	-	
Turn-on Delay Time	t _{d(on)}	V _{DS} = -20V, V _{GS} = -10V R _L = 2.5Ω, R _G = 3Ω	-	7	-	ns
Rise Time	t _r		-	6.5	-	
Turn-off Delay Time	t _{d(off)}		-	24	-	
Fall Time	t _f		-	7.8	-	
Drain-Source Body Diode Characteristics						
Body Diode voltage ³	V _{DS}	I _S = -5A, V _{GS} =0V	-	-	-1.2	V
Continuous Source Current	I _S		-	-	-4	A

Notes:

1. Repetitive rating, pulse width limited by junction temperature T_{J(MAX)}=150°C.
2. The data tested by surface mounted on a 1 inch2 FR-4 board with 2OZ copper, The value in any given application depends on the user's specific board design.
3. Pulse Test: Pulse width≤300μs, duty cycle≤2%.
4. This value is guaranteed by design hence it is not included in the production test.



CST2319 P-Ch 40V Fast Switching MOSFETs

CST2319 Typical Characteristics

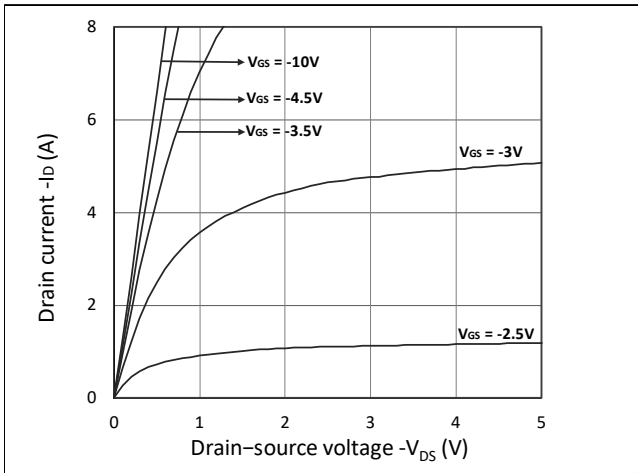

Figure 1. Output Characteristics

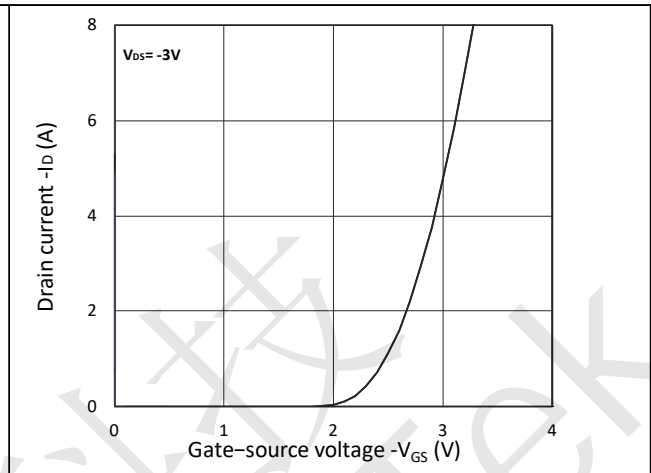

Figure 2. Transfer Characteristics

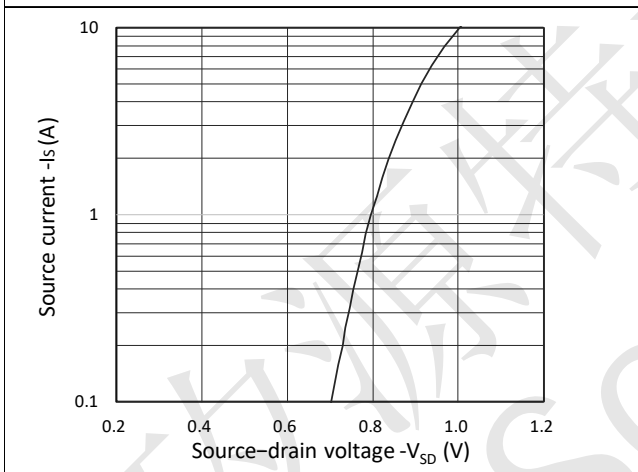

Figure 3. Forward Characteristics of Reverse

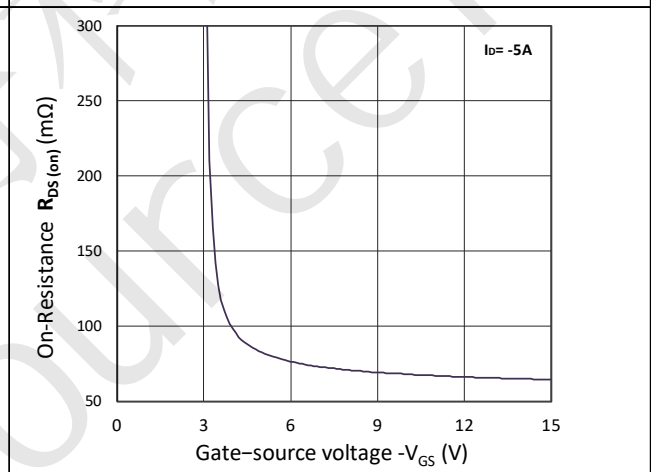

Figure 4. $R_{DS(ON)}$ vs. V_{GS}

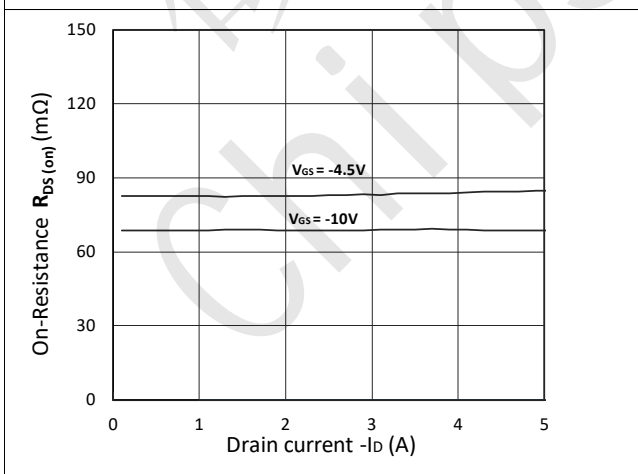

Figure 5. $R_{DS(ON)}$ vs. I_D

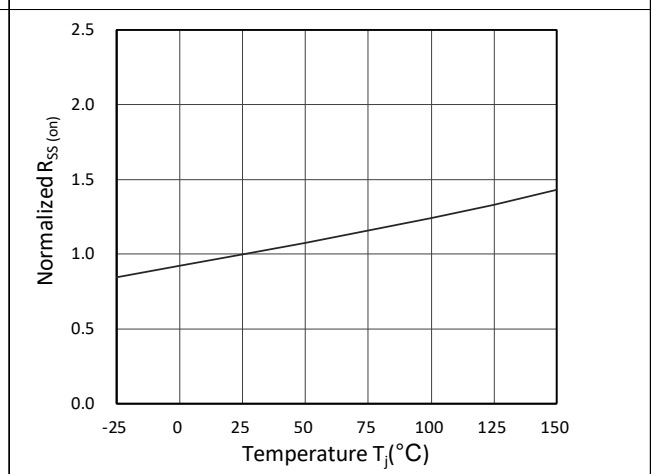

Figure 6. Normalized $R_{DS(ON)}$ vs. Temperature



CST2319 P-Ch 40V Fast Switching MOSFETs

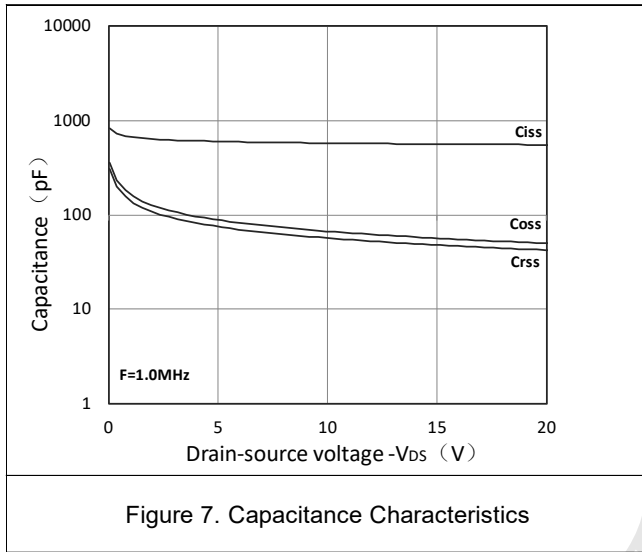

Figure 7. Capacitance Characteristics

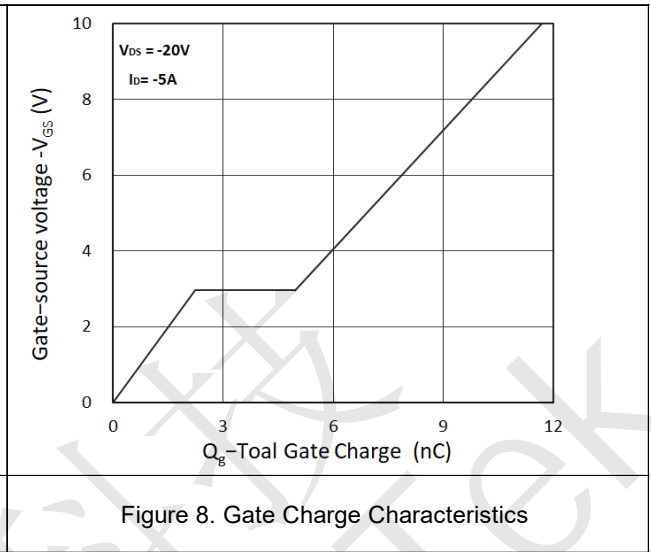
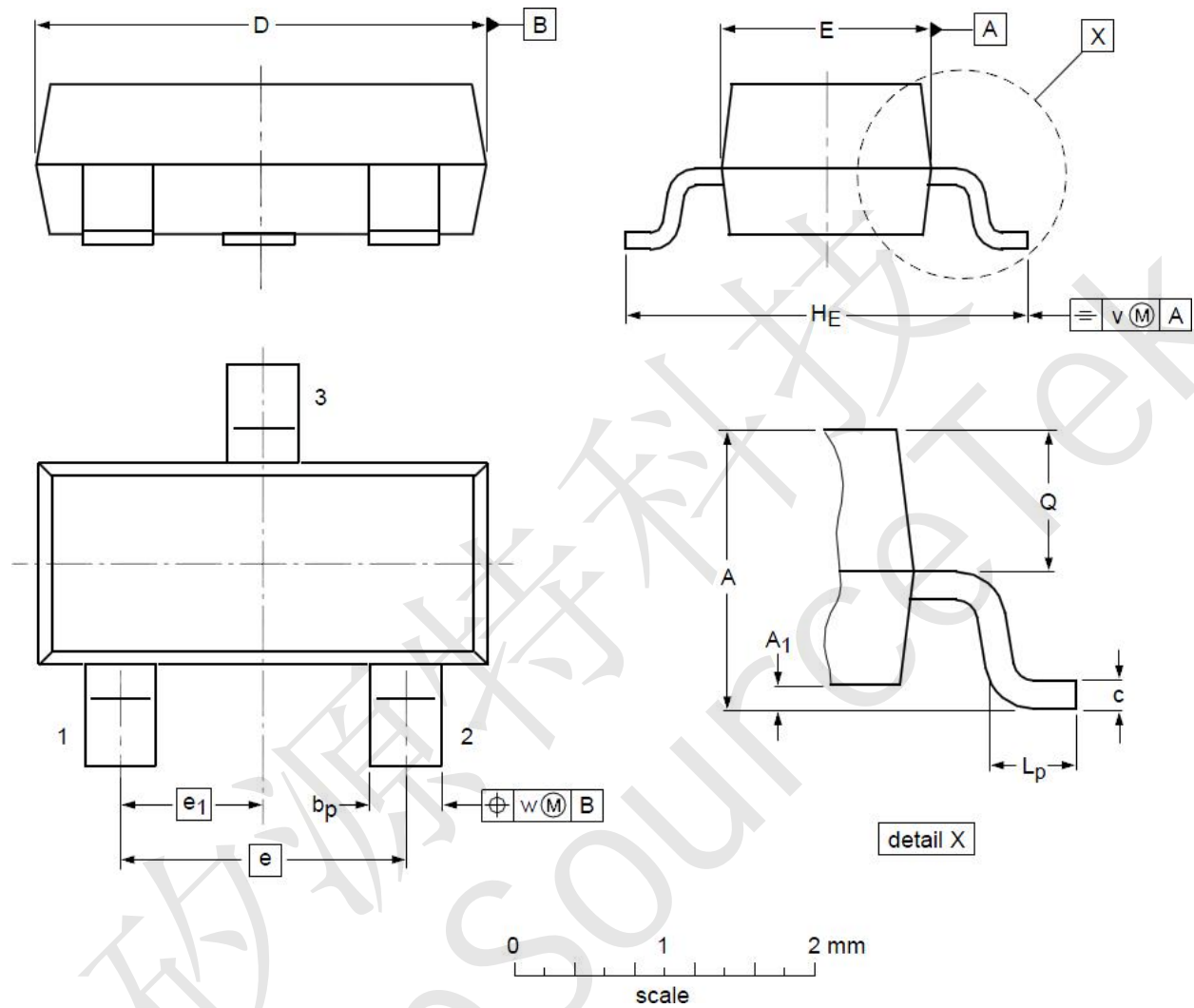

Figure 8. Gate Charge Characteristics



CST2319 P-Ch 40V Fast Switching MOSFETs

CST2319 SOT23 Mechanical Data



DIMENSIONS (unit : mm)

Symbol	Min	Typ	Max	Symbol	Min	Typ	Max
A	0.90	1.01	1.15	A ₁	0.01	0.05	0.10
b _p	0.30	0.42	0.50	c	0.08	0.13	0.15
D	2.80	2.92	3.00	E	1.20	1.33	1.40
e	--	1.90	--	e ₁	--	0.95	--
H _E	2.25	2.40	2.55	L _p	0.30	0.42	0.50
Q	0.45	0.49	0.55	v	--	0.20	--
w	--	0.10	--				