



CST230N03C N-Ch 30V Fast Switching MOSFETs



CST230N03C Features

- Split Gate Trench MOSFET technology
- Excellent package for heat dissipation
- High density cell design for low $R_{DS(ON)}$

CST230N03C Product Summary

BVDSS	RDSON	ID
30V	0.8mΩ	230A

CST230N03C Applications

- DC-DC Converters
- Power management functions
- Synchronous-rectification applications

CST230N03C PDFN5X6 Pin Configuration



CST230N03C Absolute Maximum Ratings

Parameter	Symbol	Value	Unit
Drain-Source Voltage	V_{DS}	30	V
Gate-Source Voltage	V_{GS}	±20	V
Continuous Drain Current	I_D	$T_C=25^\circ\text{C}$	230
		$T_C=100^\circ\text{C}$	100
Pulsed Drain Current ¹	I_{DM}	400	A
Single Pulse Avalanche Energy ²	EAS	156	mJ
Total Power Dissipation	P_D	93	W
Operating Junction and Storage Temperature Range	T_J, T_{STG}	-55 to 150	°C

CST230N03C Thermal Characteristics

Parameter	Symbol	Value	Unit
Thermal Resistance from Junction-to-Ambient ³	$R_{\theta JA}$	50	°C/W
Thermal Resistance from Junction-to-Case	$R_{\theta JC}$	1.35	°C/W



CST230N03C N-Ch 30V Fast Switching MOSFETs

CST230N03C Electrical Characteristics (T_J = 25°C, unless otherwise noted)

Parameter		Symbol	Test Conditions	Min.	Typ.	Max.	Unit
Static Characteristics							
Drain-Source Breakdown Voltage		V _{(BR)DSS}	V _{GS} = 0V, I _D = 250μA	30	-	-	V
Gate-body Leakage Current		I _{GSS}	V _{DS} = 0V, V _{GS} = ±20V	-	-	±100	nA
Zero Gate Voltage Drain Current	T _J =25°C	I _{DSS}	V _{DS} = 30V, V _{GS} = 0V	-	-	1	μA
	T _J =125°C			-	1.5	-	
Gate-Threshold Voltage		V _{GS(th)}	V _{DS} = V _{GS} , I _D = 250μA	1.3	-	2.3	V
Drain-Source On-Resistance ⁴		R _{DS(on)}	V _{GS} = 10V, I _D = 20A	-	0.8	1.1	mΩ
			V _{GS} = 4.5V, I _D = 10A	-	-	-	
Forward Transconductance ⁴		g _{fs}	V _{DS} = 10V, I _D = 20A	-	130	-	S
Dynamic Characteristics⁵							
Input Capacitance		C _{iss}	V _{DS} = 15V, V _{GS} = 0V, f = 1MHz	-	5903	-	pF
Output Capacitance		C _{oss}		-	3216	-	
Reverse Transfer Capacitance		C _{rss}		-	204	-	
Gate Resistance		R _g	f = 1MHz	-	1.3	-	Ω
Switching Characteristics⁵							
Total Gate Charge		Q _g	V _{GS} = 4.5V, V _{DS} = 15V, I _D = 30A	-	40	-	nC
Gate-Source Charge		Q _{gs}		-	23	-	
Gate-Drain Charge		Q _{gd}		-	9.9	-	
Turn-On Delay Time		t _{d(on)}	V _{GS} = 4.5V, V _{DD} = 15V, R _G = 3Ω, I _D = 15A	-	43	-	ns
Rise Time		t _r		-	80	-	
Turn-Off Delay Time		t _{d(off)}		-	52	-	
Fall Time		t _f		-	32	-	
Body Diode Reverse Recovery Time		t _{rr}	I _F = 30A, dI/dt = 100A/μs	-	67	-	ns
Body Diode Reverse Recovery Charge		Q _{rr}		-	90	-	nC
Drain-Source Body Diode Characteristics							
Diode Forward Voltage ⁴		V _{SD}	I _S = 10A, V _{GS} = 0V	-	-	1.4	V
Continuous Source Current		I _S	T _C = 25°C	-	-	100	A

Notes:

1. Repetitive rating, pulse width limited by junction temperature T_{J(MAX)} = 150°C.
2. The EAS data shows Max. rating. The test condition is V_{DD} = 24V, V_{GS} = 10V, L = 0.1mH, R_G = 25Ω.
3. The data tested by surface mounted on a 1 inch² FR-4 board with 20Z copper, The value in any given application depends on the user's specific board design.
4. The data tested by pulsed, pulse width ≤ 300us, duty cycle ≤ 2%.
5. This value is guaranteed by design hence it is not included in the production test.



CST230N03C Typical Characteristics

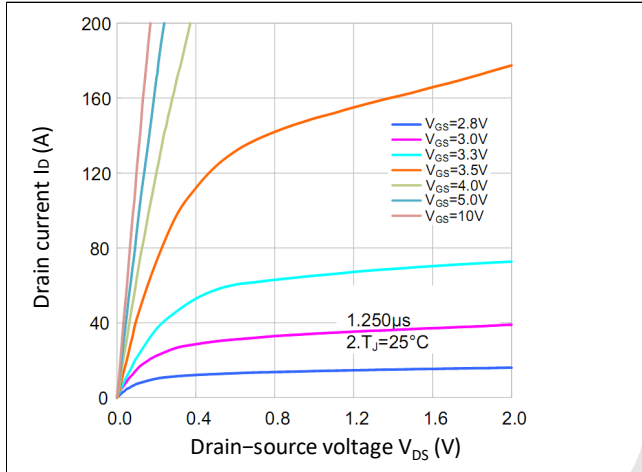

Figure 1. Output Characteristics

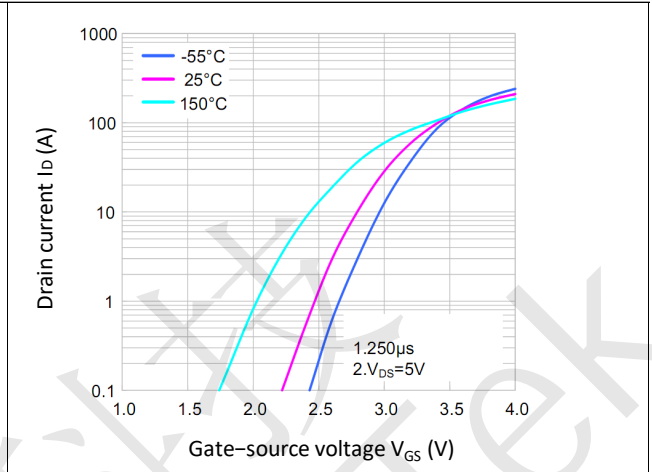

Figure 2. Transfer Characteristics

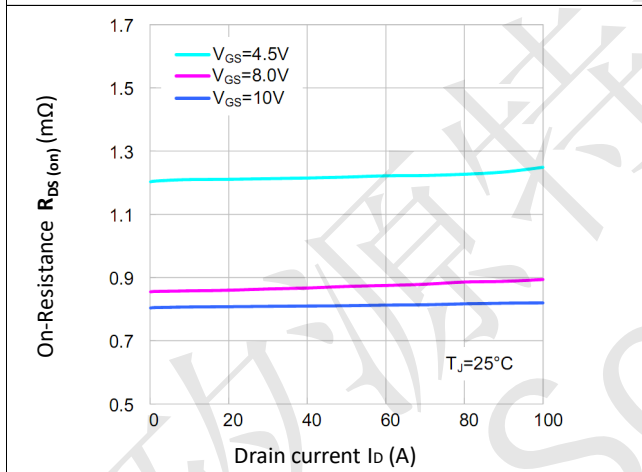

Figure 3. $R_{DS(ON)}$ vs. I_D

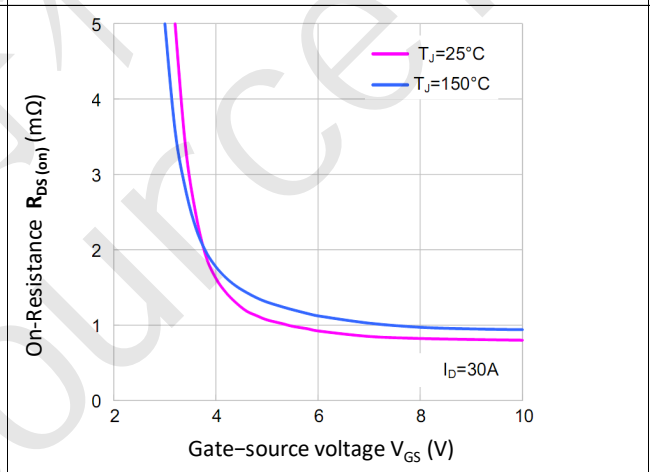

Figure 4. $R_{DS(ON)}$ vs. V_{GS}

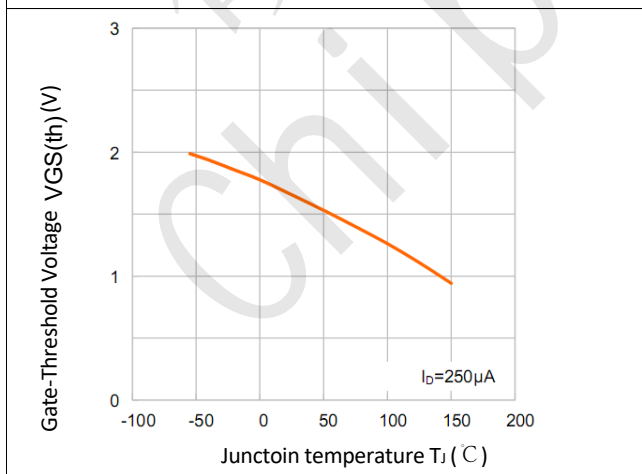

Figure 5. $V_{GS(th)}$ vs. T_J

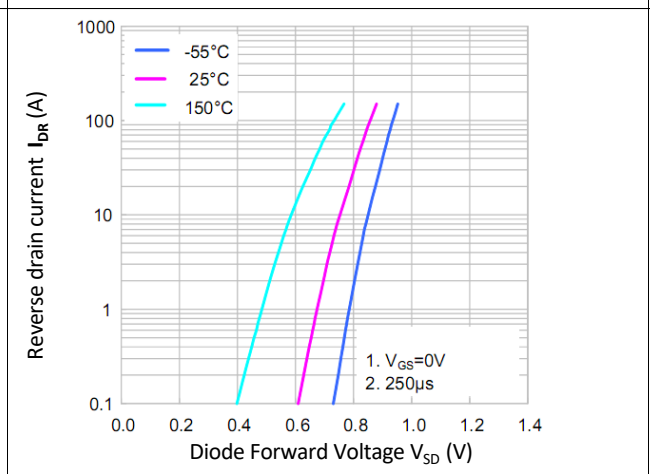

Figure 6. I_{DR} vs. V_{SD}

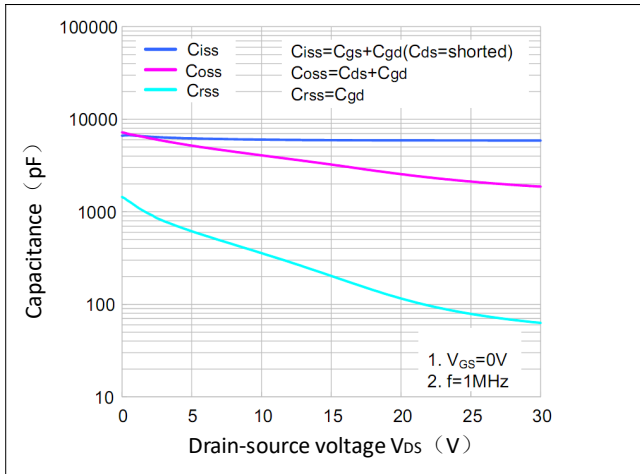

Figure 5. Capacitance Characteristics

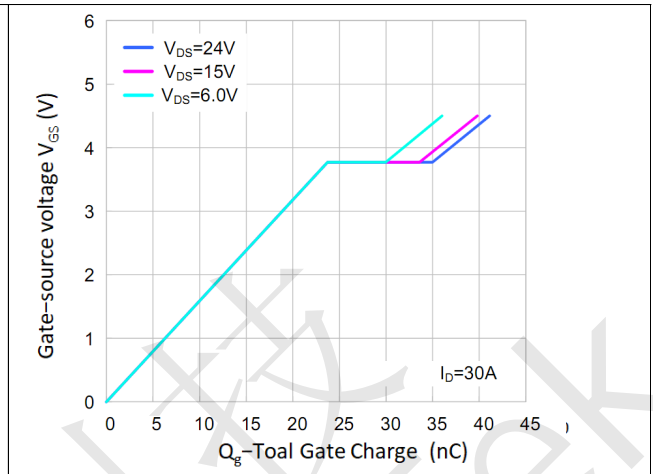

Figure 6 Gate Charge Characteristics

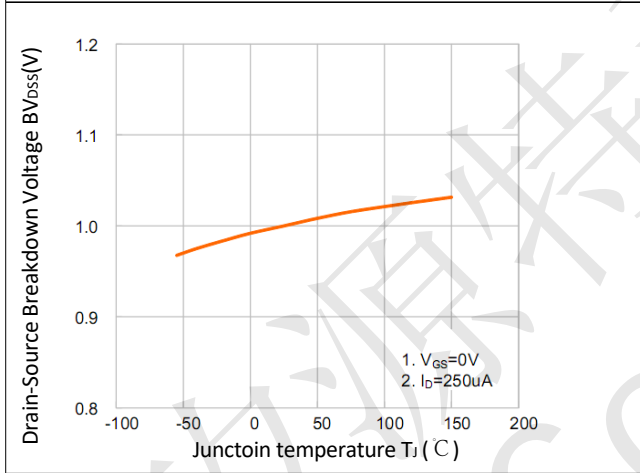

Figure 7. BV_{DSS} VS T_J

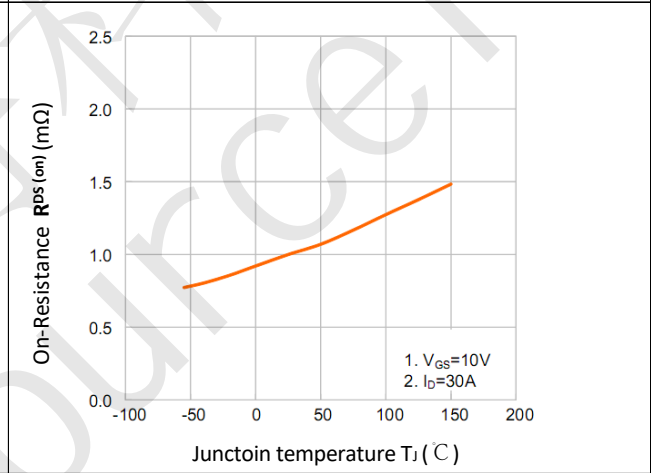

Figure 8. $R_{DS(ON)}$ VS T_J

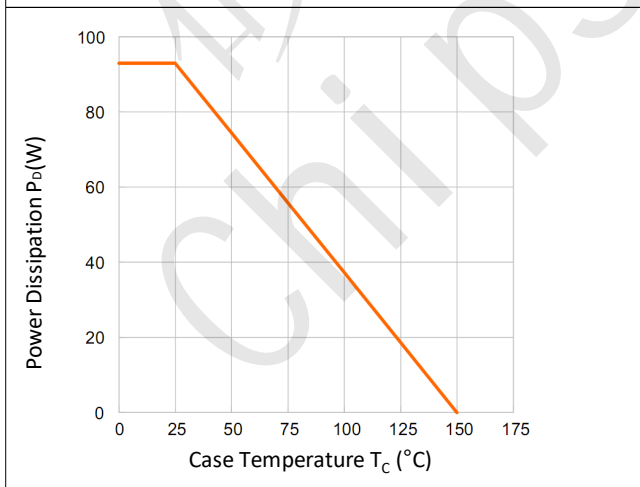

Figure 9. Power Dissipation

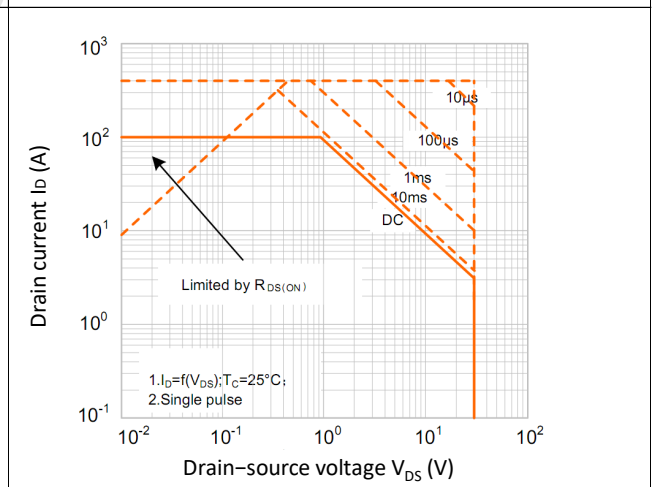

Figure 10. Safe Operating Area



CST230N03C Test Circuit

DFN5X6-8L Package Information

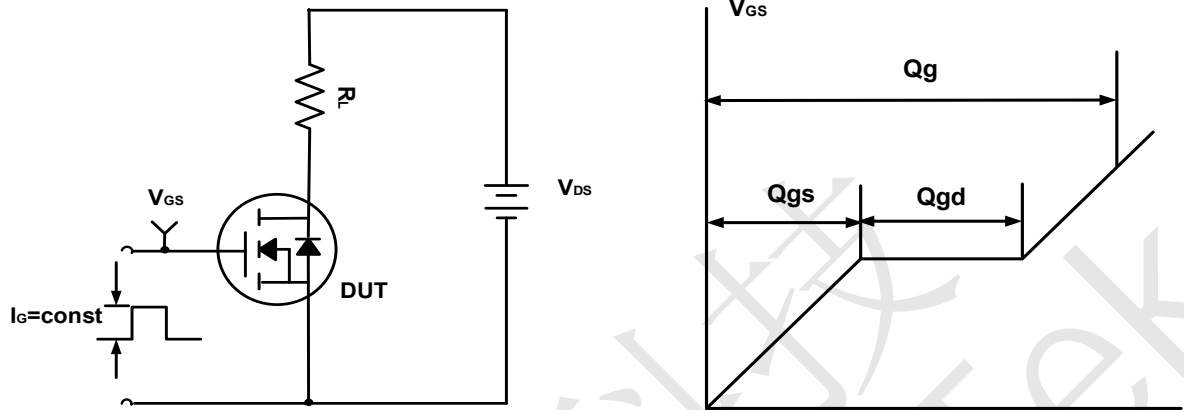

Figure A. Gate Charge Test Circuit & Waveforms

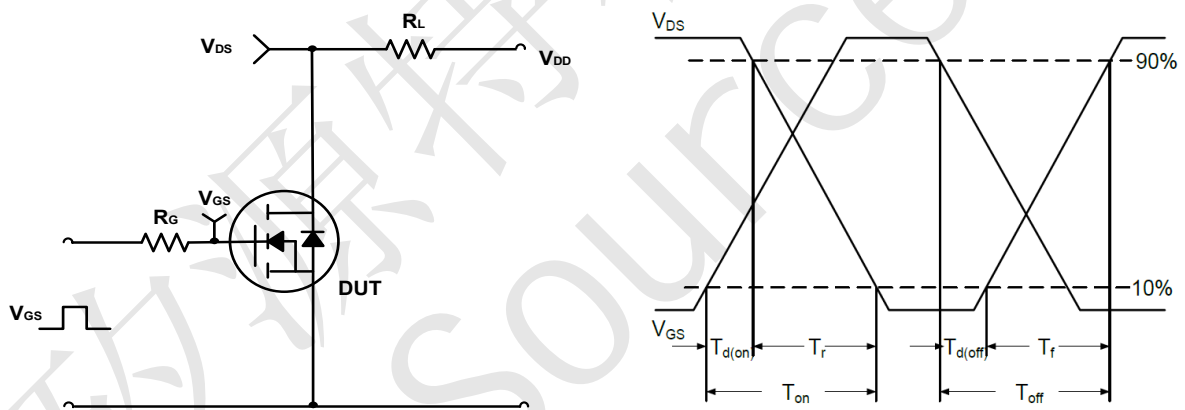

Figure B. Switching Test Circuit & Waveforms

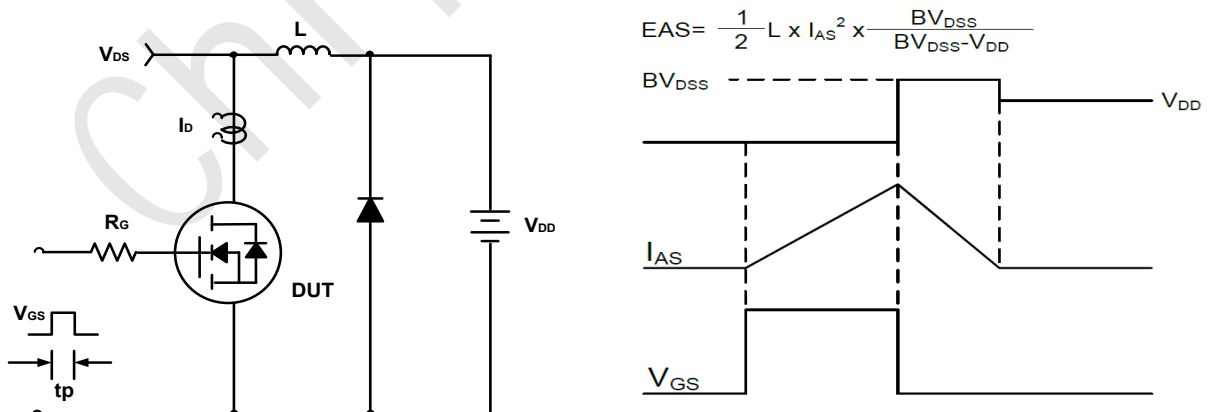
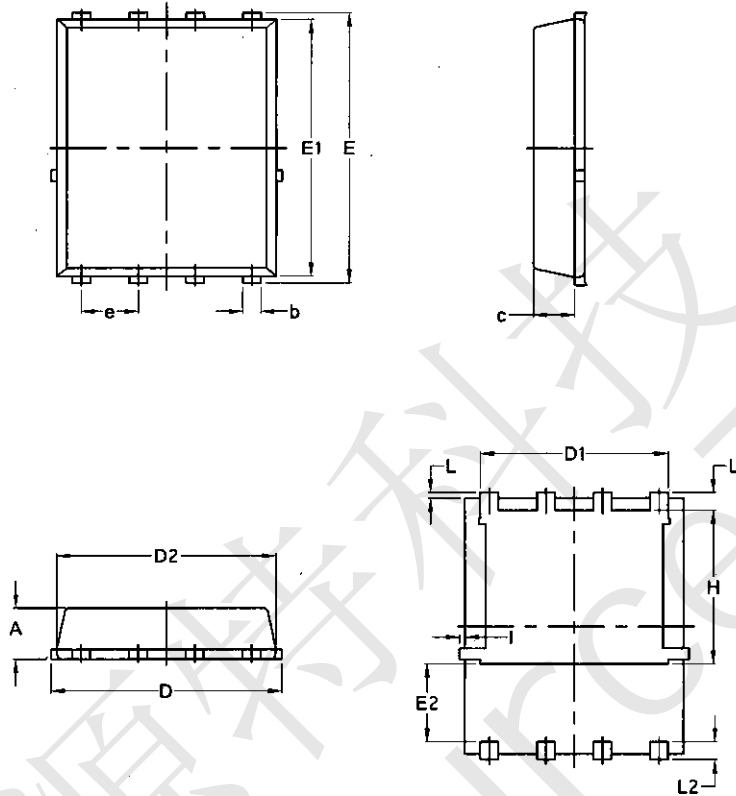

Figure C. Unclamped Inductive Switching Circuit & Waveforms



CST230N03C Package Mechanical Data-PDFN5*6-8L- Single



Symbol	Common		Inch	
	mm			
	Min	Max	Min	Max
A	1.03	1.17	0.0406	0.0461
b	0.34	0.48	0.0134	0.0189
c	0.824	0.0970	0.0324	0.082
D	4.80	5.40	0.1890	0.2126
D1	4.11	4.31	0.1618	0.1697
D2	4.80	5.00	0.1890	0.1969
E	5.95	6.15	0.2343	0.2421
E1	5.65	5.85	0.2224	0.2303
E2	1.60	/	0.0630	/
e	1.27 BSC		0.05 BSC	
L	0.05	0.25	0.0020	0.0098
L1	0.38	0.50	0.0150	0.0197
L2	0.38	0.50	0.0150	0.0197
H	3.30	3.50	0.1299	0.1378
I	/	0.18	/	0.0070