



### CST2302 N-Ch 20V Fast Switching MOSFETs

- ★ Green Device Available
- ★ Super Low Gate Charge
- ★ Excellent Cdv/dt effect decline
- ★ Advanced high cell density Trench technology

#### CST2302 Product Summary

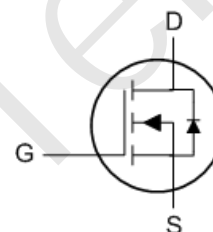
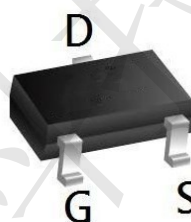


BVDSS	R <sub>DS(on)</sub>	I <sub>D</sub>
20V	21mΩ	5.2A

#### CST2302 Description

The CST2302 is the high cell density trenched N-ch MOSFETs, which provides excellent R<sub>DS(on)</sub> and efficiency for most of the small power switching and load switch applications. The CST2302 meet the RoHS and Green Product requirement with full function reliability approved.

#### CST2302 SOT23 Pin Configuration



#### CST2302 Absolute Maximum Ratings

Symbol	Parameter	Rating	Units
V <sub>DS</sub>	Drain-Source Voltage	20	V
V <sub>GS</sub>	Gate-Source Voltage	±12	V
I <sub>D</sub> @T <sub>A</sub> =25°C	Continuous Drain Current, V <sub>GS</sub> @ 4.5V <sup>1</sup>	5.2	A
I <sub>D</sub> @T <sub>A</sub> =70°C	Continuous Drain Current, V <sub>GS</sub> @ 4.5V <sup>1</sup>	3.0	A
I <sub>DM</sub>	Pulsed Drain Current <sup>2</sup>	16.4	A
P <sub>D</sub> @T <sub>A</sub> =25°C	Total Power Dissipation <sup>3</sup>	1.0	W
T <sub>STG</sub>	Storage Temperature Range	-55 to 150	°C
T <sub>J</sub>	Operating Junction Temperature Range	-55 to 150	°C

#### CST2302 Thermal Data

Symbol	Parameter	Typ.	Max.	Unit
R <sub>θJA</sub>	Thermal Resistance Junction-ambient <sup>1</sup>	---	170	°C/W
R <sub>θJC</sub>	Thermal Resistance Junction-Case <sup>1</sup>	---	---	°C/W



### CST2302 N-Ch 20V Fast Switching MOSFETs

#### CST2302 Electrical Characteristics ( $T_J=25^{\circ}\text{C}$ unless otherwise specified)

Symbol	Parameter	Test Condition	Min.	Typ.	Max.	Units
<b>Off Characteristic</b>						
$V_{(BR)DSS}$	Drain-Source Breakdown Voltage	$V_{GS}=0V, I_D=250\mu A$	20	-	-	V
$I_{DSS}$	Zero Gate Voltage Drain Current	$V_{DS}=20V, V_{GS}=0V,$	-	-	1.0	$\mu A$
$I_{GSS}$	Gate to Body Leakage Current	$V_{DS}=0V, V_{GS}=\pm 12V$	-	-	$\pm 100$	nA
<b>On Characteristics</b>						
$V_{GS(th)}$	Gate Threshold Voltage	$V_{DS}=V_{GS}, I_D=250\mu A$	0.4	0.7	1	V
$R_{DS(on)}$	Static Drain-Source on-Resistance note2	$V_{GS}=4.5V, I_D=4A$	-	21	27	m $\Omega$
		$V_{GS}=2.5V, I_D=3A$	-	29	44	
<b>Dynamic Characteristics</b>						
$C_{iss}$	Input Capacitance	$V_{DS}=10V, V_{GS}=0V,$ $f=1.0MHz$	-	358	-	pF
$C_{oss}$	Output Capacitance		-	69.3	-	pF
$C_{riss}$	Reverse Transfer Capacitance		-	58.5	-	pF
$Q_g$	Total Gate Charge	$V_{DS}=10V, I_D=2A,$ $V_{GS}=4.5V$	-	5.6	-	nC
$Q_{gs}$	Gate-Source Charge		-	0.8	-	nC
$Q_{gd}$	Gate-Drain("Miller") Charge		-	1	-	nC
<b>Switching Characteristics</b>						
$t_{d(on)}$	Turn-on Delay Time	$V_{DS}=10V,$ $I_D=4A, R_{GEN}=3\Omega,$ $V_{GS}=4.5V$	-	5	-	ns
$t_r$	Turn-on Rise Time		-	30	-	ns
$t_{d(off)}$	Turn-off Delay Time		-	48	-	ns
$t_f$	Turn-off Fall Time		-	36	-	ns
<b>Drain-Source Diode Characteristics and Maximum Ratings</b>						
$I_S$	Maximum Continuous Drain to Source Diode Forward Current		-	-	4	A
$I_{SM}$	Maximum Pulsed Drain to Source Diode Forward Current		-	-	16	A
$V_{SD}$	Drain to Source Diode Forward Voltage	$V_{GS}=0V, I_S=4A$	-	-	1.2	V

Notes: 1. Repetitive Rating: Pulse Width Limited by Maximum Junction Temperature

2. Pulse Test: Pulse Width $\leq 300\mu s$ , Duty Cycle $\leq 0.5\%$



## CST2302 Typical Performance Characteristics

Figure 1: Output Characteristics

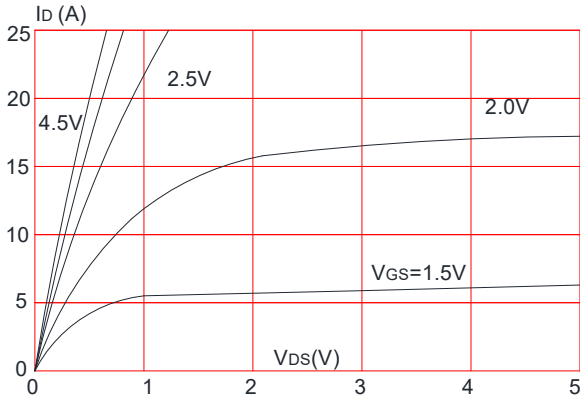


Figure 2: Typical Transfer Characteristics

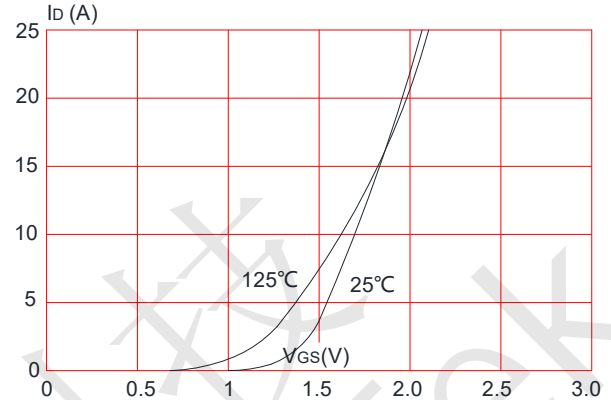


Figure 3: On-resistance vs. Drain Current

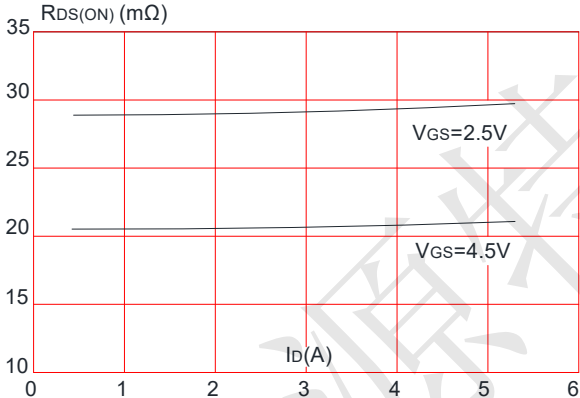


Figure 4: Body Diode Characteristics

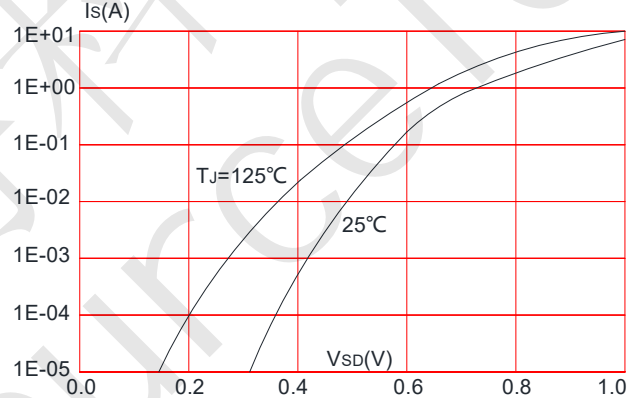


Figure 5: Gate Charge Characteristics

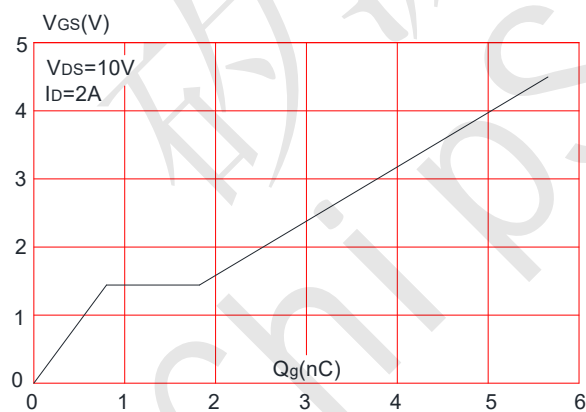
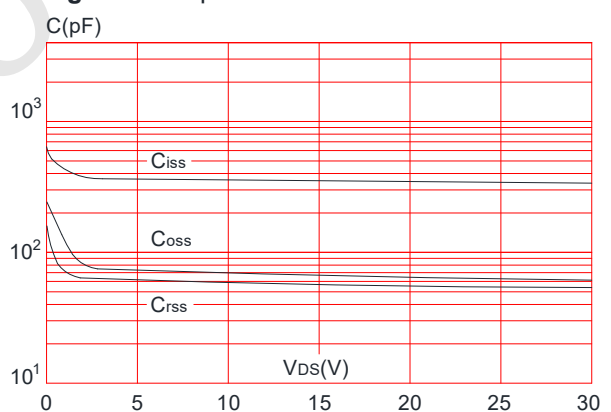


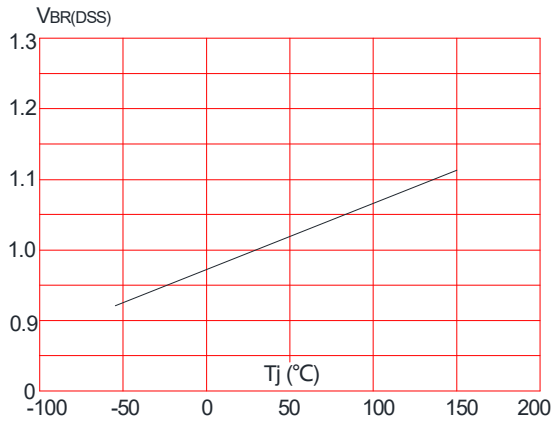
Figure 6: Capacitance Characteristics



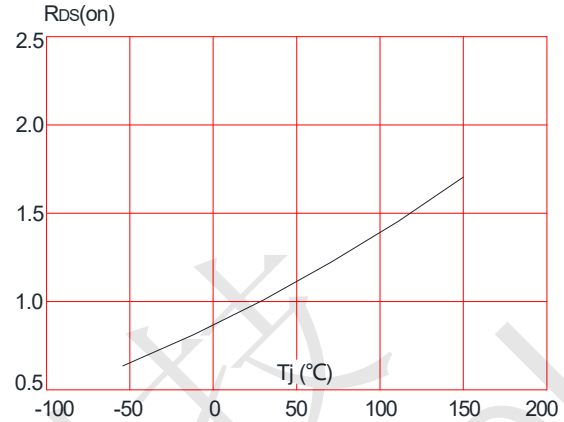


### CST2302 N-Ch 20V Fast Switching MOSFETs

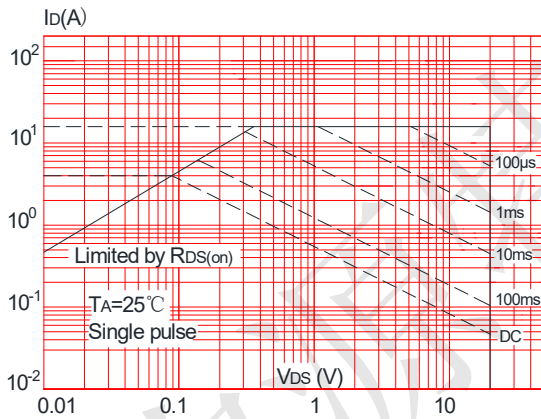
**Figure 7:** Normalized Breakdown Voltage vs. Junction Temperature



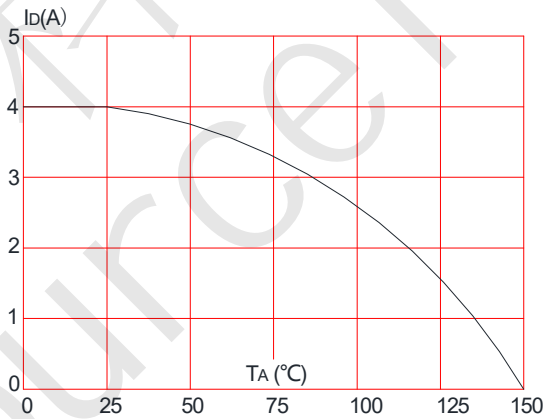
**Figure 8:** Normalized on Resistance vs. Junction Temperature



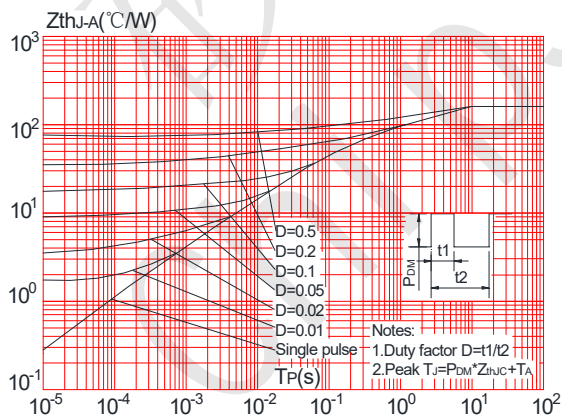
**Figure 9:** Maximum Safe Operating Area



**Figure 10:** Maximum Continuous Drain Current vs. Ambient Temperature

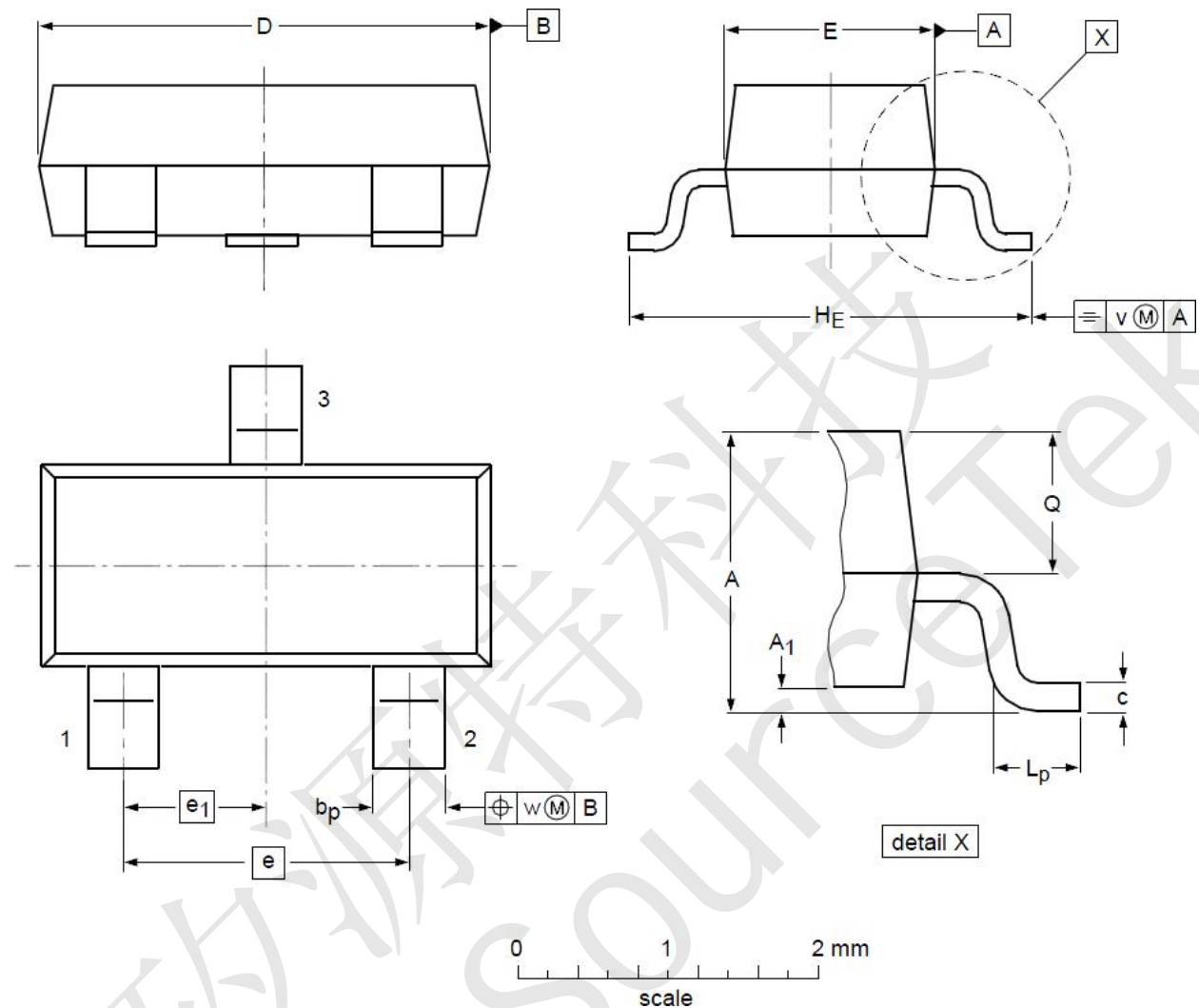


**Figure 11:** Maximum Effective Transient Thermal Impedance, Junction-to-Ambient





CST2302 Package Mechanical Data-SOT-23



**DIMENSIONS** ( unit : mm )

Symbol	Min	Typ	Max	Symbol	Min	Typ	Max
A	0.90	1.01	1.15	A <sub>1</sub>	0.01	0.05	0.10
b <sub>p</sub>	0.30	0.42	0.50	c	0.08	0.13	0.15
D	2.80	2.92	3.00	E	1.20	1.33	1.40
e	--	1.90	--	e <sub>1</sub>	--	0.95	--
H <sub>E</sub>	2.25	2.40	2.55	L <sub>p</sub>	0.30	0.42	0.50
Q	0.45	0.49	0.55	v	--	0.20	--
w	--	0.10	--				