



CST2301A P-Ch 20V Fast Switching MOSFETs

- ★ Green Device Available
- ★ Super Low Gate Charge
- ★ Excellent Cdv/dt effect decline
- ★ Advanced high cell density Trench technology

CST2301A Product Summary



BVDSS	RDSON	ID
-20V	55mΩ	-3.3 A

CST2301A Description

The CST2301A is the high cell density trenched P-ch MOSFETs, which provides excellent RDSON and efficiency for most of the small power switching and load switch applications.

The CST2301A meet the RoHS and Green Product requirement with full function reliability approved.

CST2301A SOT23 Pin Configuration

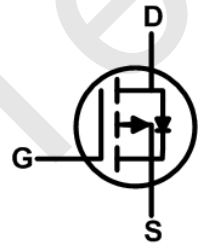
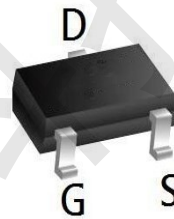

CST2301A Absolute Maximum Ratings

Symbol	Parameter	Rating	Units
V_{DS}	Drain-Source Voltage	-20	V
V_{GS}	Gate-Source Voltage	± 12	V
$I_D@T_A=25^\circ\text{C}$	Continuous Drain Current, V_{GS} @ -4.5V ¹	-3.3	A
$I_D@T_A=70^\circ\text{C}$	Continuous Drain Current, V_{GS} @ -4.5V ¹	-2.4	A
I_{DM}	Pulsed Drain Current ²	-12	A
$P_D@T_A=25^\circ\text{C}$	Total Power Dissipation ³	1	W
T_{STG}	Storage Temperature Range	-55 to 150	$^\circ\text{C}$
T_J	Operating Junction Temperature Range	-55 to 150	$^\circ\text{C}$

CST2301A Thermal Data

Symbol	Parameter	Typ.	Max.	Unit
$R_{\theta JA}$	Thermal Resistance Junction-ambient ¹	---	125	$^\circ\text{C/W}$
$R_{\theta JC}$	Thermal Resistance Junction-Case ¹	---	---	$^\circ\text{C/W}$



CST2301A P-Ch 20V Fast Switching MOSFETs

CST2301A Electrical Characteristics (T_J=25°C unless otherwise specified)

Symbol	Parameter	Test Condition	Min.	Typ.	Max.	Units
Off Characteristic						
V _{(BR)DSS}	Drain-Source Breakdown Voltage	V _{GS} =0V, I _D = -250μA	-20	-	-	V
I _{DSS}	Zero Gate Voltage Drain Current	V _{DS} = -20V, V _{GS} =0V,	-	-	-1	μA
I _{GSS}	Gate to Body Leakage Current	V _{DS} =0V, V _{GS} = ±12V	-	-	±100	nA
On Characteristics						
V _{GS(th)}	Gate Threshold Voltage	V _{DS} =V _{GS} , I _D = -250μA	-0.5	-0.7	-1.0	V
R _{DS(on)}	Static Drain-Source on-Resistance <small>note2</small>	V _{GS} = -4.5V, I _D = -3A	-	55	70	mΩ
		V _{GS} = -2.5V, I _D = -2A	-	70	100	
Dynamic Characteristics						
C _{iss}	Input Capacitance	V _{DS} = -10V, V _{GS} =0V, f=1.0MHz	-	503	-	pF
C _{oss}	Output Capacitance		-	67	-	pF
C _{rss}	Reverse Transfer Capacitance		-	58	-	pF
Q _g	Total Gate Charge	V _{DS} = -10V, I _D = -2A, V _{GS} = -4.5V	-	4.1	-	nC
Q _{gs}	Gate-Source Charge		-	0.8	-	nC
Q _{gd}	Gate-Drain("Miller") Charge		-	1.1	-	nC
Switching Characteristics						
t _{d(on)}	Turn-on Delay Time	V _{DD} = -10V, I _D = -3A, R _G =1Ω, V _{GEN} = -4.5V, R _L =1.2Ω	-	11	-	ns
t _r	Turn-on Rise Time		-	52	-	ns
t _{d(off)}	Turn-off Delay Time		-	16	-	ns
t _f	Turn-off Fall Time		-	10	-	ns
Drain-Source Diode Characteristics and Maximum Ratings						
I _S	Maximum Continuous Drain to Source Diode Forward Current		-	-	-3	A
I _{SM}	Maximum Pulsed Drain to Source Diode Forward Current		-	-	-12	A
V _{SD}	Drain to Source Diode Forward Voltage	V _{GS} =0V, I _S = -3A	-	-	-1.2	V

Notes:1. Repetitive Rating: Pulse Width Limited by Maximum Junction Temperature

2. Pulse Test: Pulse Width≤300μs, Duty Cycle≤2%



CST2301A Typical Performance Characteristics

Figure 1: Output Characteristics

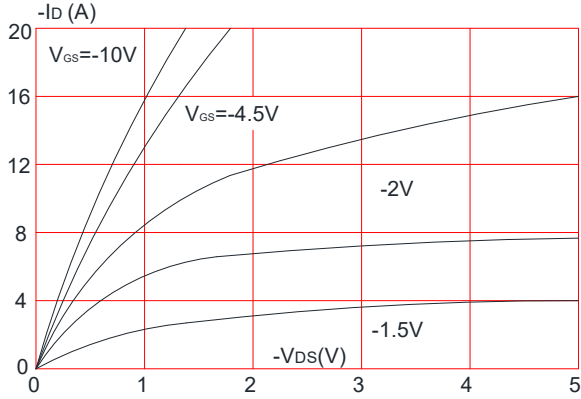

Figure 2: Typical Transfer Characteristics

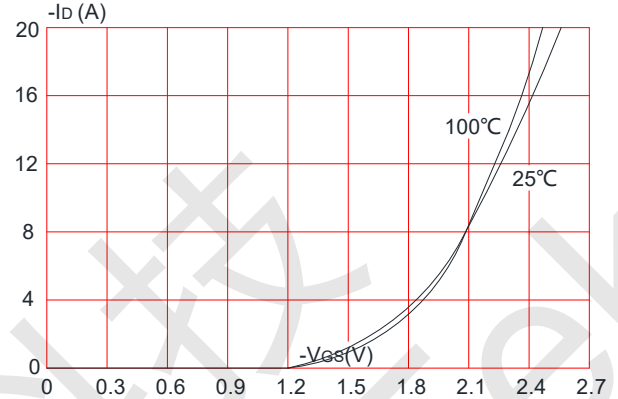

Figure 3: On-resistance vs. Drain Current

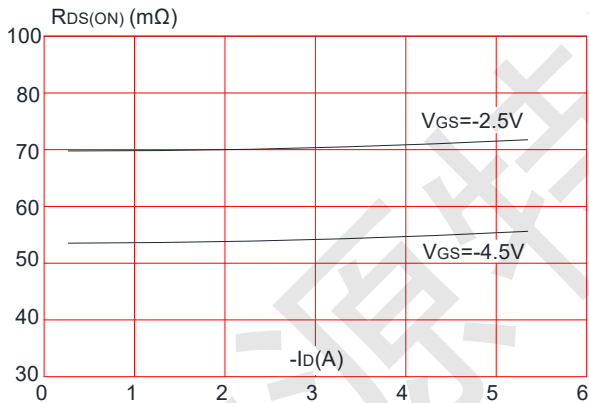

Figure 4: Body Diode Characteristics

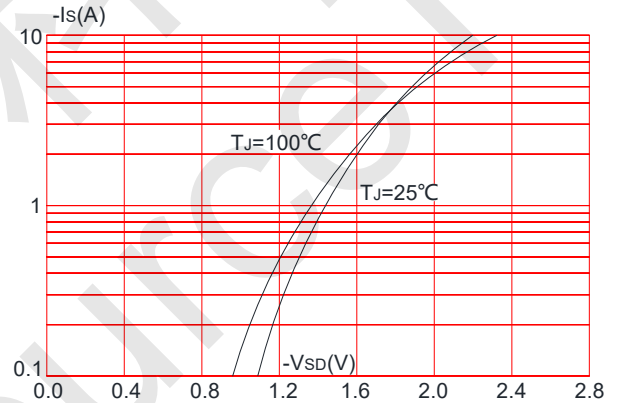

Figure 5: Gate Charge Characteristics

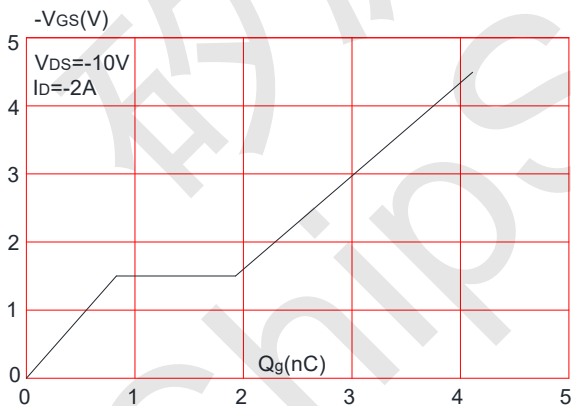
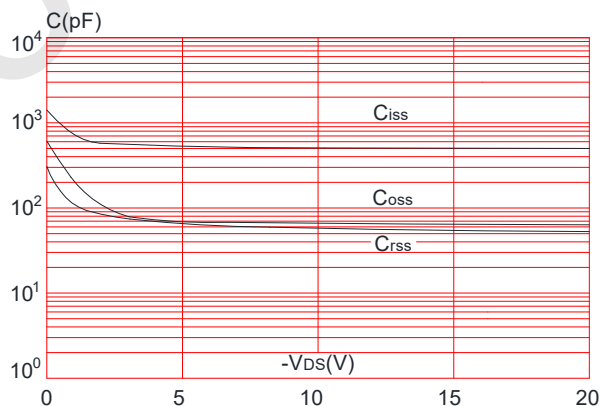

Figure 6: Capacitance Characteristics





CST2301A P-Ch 20V Fast Switching MOSFETs

Figure 7: Normalized Breakdown Voltage vs. Junction Temperature

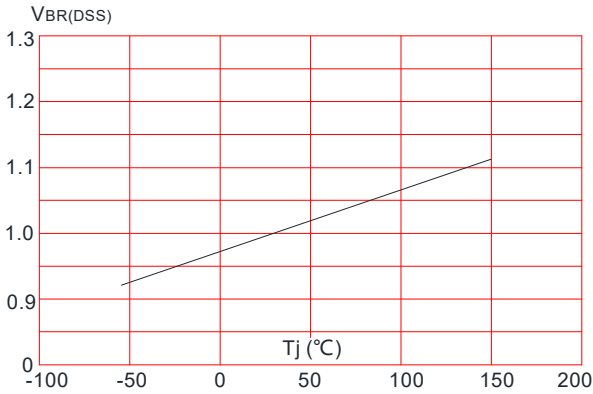

Figure 8: Normalized on Resistance vs. Junction Temperature

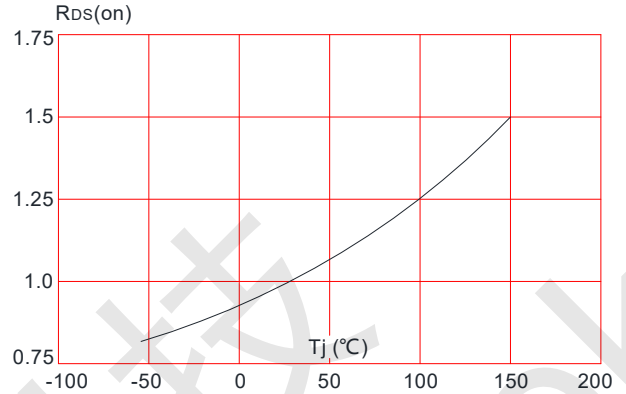

Figure 9: Maximum Safe Operating Area

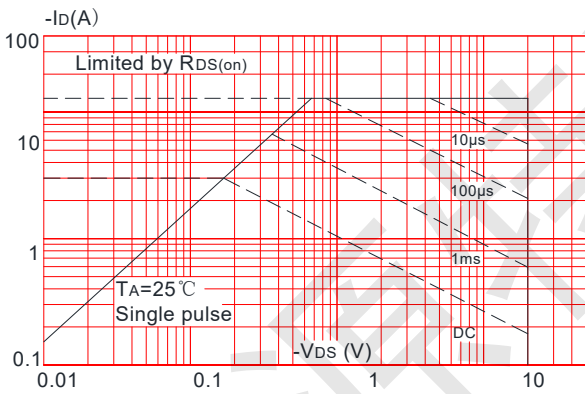

Figure 10: Maximum Continuous Drain Current vs. Ambient Temperature

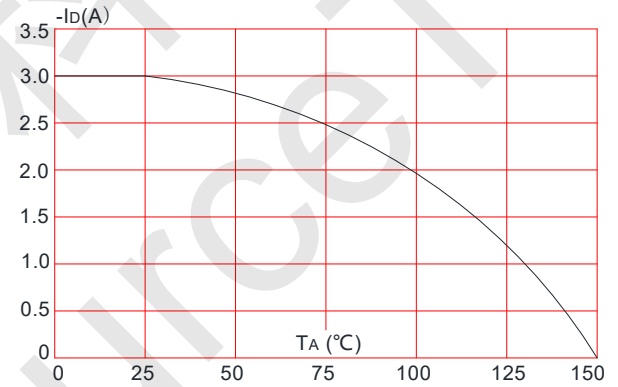
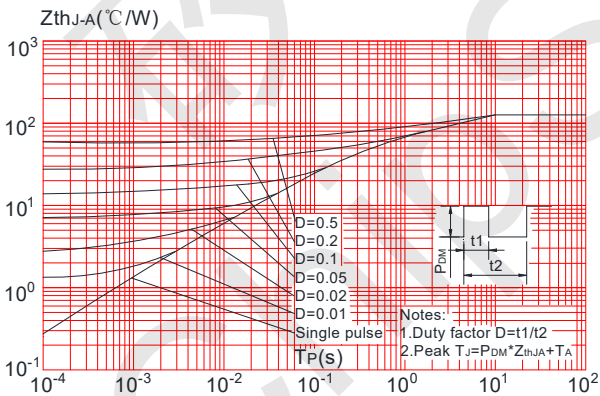
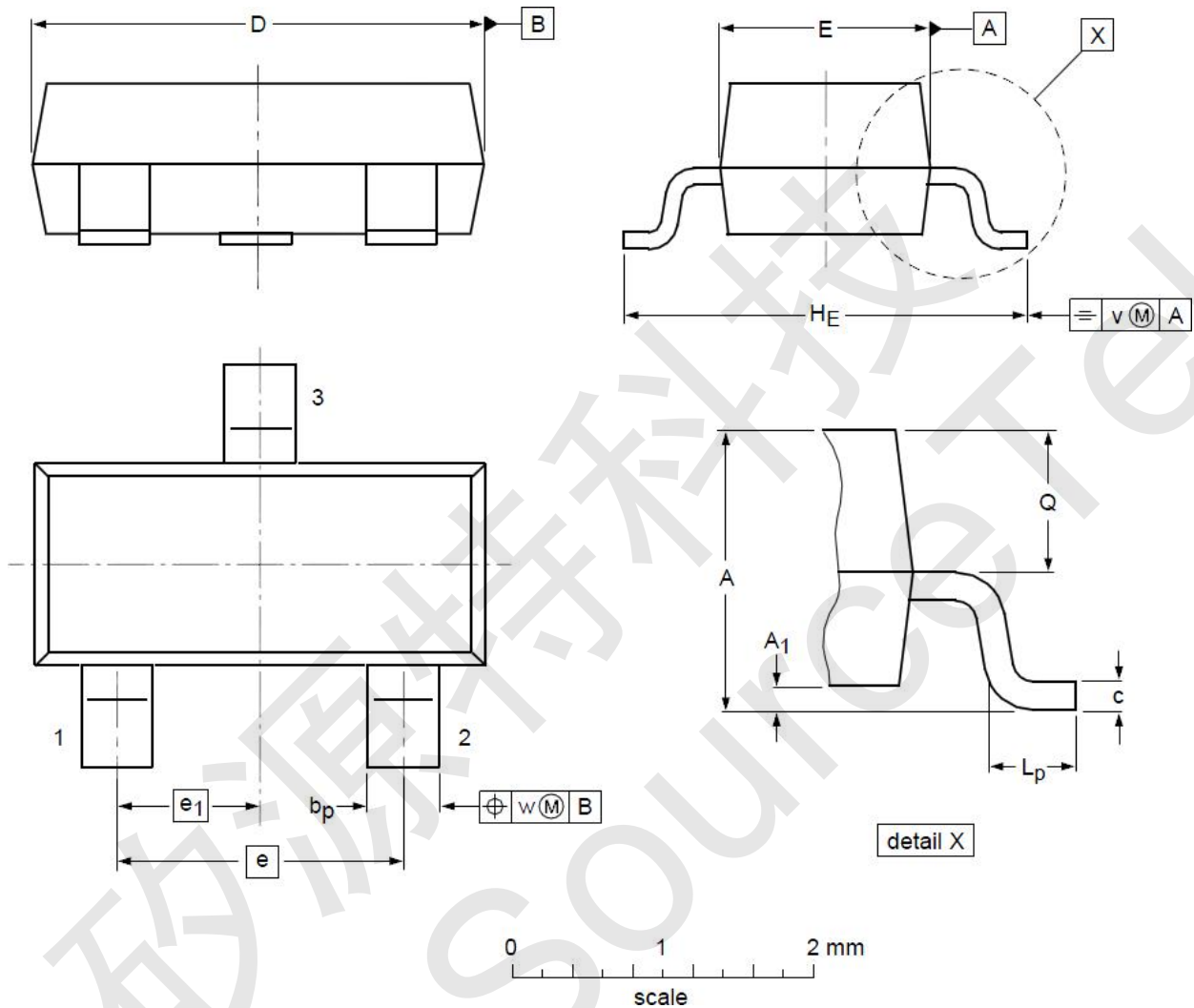

Figure.11: Maximum Effective Transient Thermal Impedance, Junction-to-Ambient





CST2301A Package Mechanical Data-SOT-23



DIMENSIONS (unit : mm)

Symbol	Min	Typ	Max	Symbol	Min	Typ	Max
A	0.90	1.01	1.15	A ₁	0.01	0.05	0.10
b _p	0.30	0.42	0.50	c	0.08	0.13	0.15
D	2.80	2.92	3.00	E	1.20	1.33	1.40
e	--	1.90	--	e ₁	--	0.95	--
H _E	2.25	2.40	2.55	L _p	0.30	0.42	0.50
Q	0.45	0.49	0.55	v	--	0.20	--
w	--	0.10	--				