



### CST2300L N-Ch 20V Fast Switching MOSFETs

- ★ Green Device Available
- ★ Super Low Gate Charge
- ★ Excellent Cdv/dt effect decline
- ★ Advanced high cell density Trench technology

#### CST2300L Product Summary

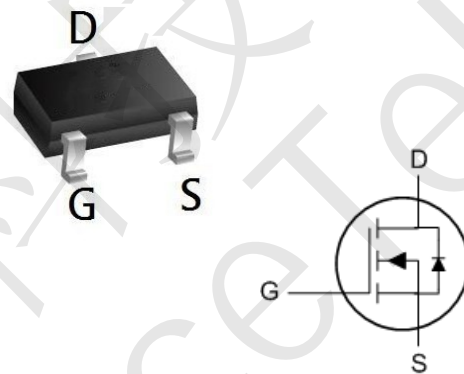


BVDSS	RDSON	ID
20V	18 mΩ	6.0A

#### CST2300L Description

The CST2300L is the high cell density trenched N-ch MOSFETs, which provides excellent RDSON and efficiency for most of the small power switching and load switch applications. The CST2300L meet the RoHS and Green Product requirement with full function reliability approved.

#### CST2300L SOT23-3L Pin Configuration



#### CST2300L Absolute Maximum Ratings

Symbol	Parameter	Rating	Units
$V_{DS}$	Drain-Source Voltage	20	V
$V_{GS}$	Gate-Source Voltage	$\pm 12$	V
$I_D@T_A=25^\circ C$	Continuous Drain Current, $V_{GS} @ 4.5V^1$	6.0	A
$I_D@T_A=70^\circ C$	Continuous Drain Current, $V_{GS} @ 4.5V^1$	3.0	A
$I_{DM}$	Pulsed Drain Current <sup>2</sup>	16.4	A
$P_D@T_A=25^\circ C$	Total Power Dissipation <sup>3</sup>	1.0	W
$T_{STG}$	Storage Temperature Range	-55 to 150	$^\circ C$
$T_J$	Operating Junction Temperature Range	-55 to 150	$^\circ C$

#### CST2300L Thermal Data

Symbol	Parameter	Typ.	Max.	Unit
$R_{\theta JA}$	Thermal Resistance Junction-ambient <sup>1</sup>	---	170	$^\circ C/W$
$R_{\theta JC}$	Thermal Resistance Junction-Case <sup>1</sup>	---	---	$^\circ C/W$



### CST2300L N-Ch 20V Fast Switching MOSFETs

#### CST2300L Electrical Characteristics ( $T_J=25^\circ\text{C}$ unless otherwise specified)

Symbol	Parameter	Test Condition	Min.	Typ.	Max.	Units
<b>Off Characteristic</b>						
$V_{(BR)DSS}$	Drain-Source Breakdown Voltage	$V_{GS}=0V, I_D=250\mu A$	20	-	-	V
$I_{DSS}$	Zero Gate Voltage Drain Current	$V_{DS}=20V, V_{GS}=0V,$	-	-	1.0	$\mu A$
$I_{GSS}$	Gate to Body Leakage Current	$V_{DS}=0V, V_{GS}=\pm 12V$	-	-	$\pm 100$	nA
<b>On Characteristics</b>						
$V_{GS(th)}$	Gate Threshold Voltage	$V_{DS}=V_{GS}, I_D=250\mu A$	0.4	0.7	1	V
$R_{DS(on)}$	Static Drain-Source on-Resistance note2	$V_{GS}=4.5V, I_D=4A$	-	18	24	m $\Omega$
		$V_{GS}=2.5V, I_D=3A$	-	25	41	
<b>Dynamic Characteristics</b>						
$C_{iss}$	Input Capacitance	$V_{DS}=10V, V_{GS}=0V,$ $f=1.0MHz$	-	358	-	pF
$C_{oss}$	Output Capacitance		-	69.3	-	pF
$C_{rss}$	Reverse Transfer Capacitance		-	58.5	-	pF
$Q_g$	Total Gate Charge	$V_{DS}=10V, I_D=2A,$ $V_{GS}=4.5V$	-	5.6	-	nC
$Q_{gs}$	Gate-Source Charge		-	0.8	-	nC
$Q_{gd}$	Gate-Drain("Miller") Charge		-	1	-	nC
<b>Switching Characteristics</b>						
$t_{d(on)}$	Turn-on Delay Time	$V_{DS}=10V,$ $I_D=4A, R_{GEN}=3\Omega,$ $V_{GS}=4.5V$	-	5	-	ns
$t_r$	Turn-on Rise Time		-	30	-	ns
$t_{d(off)}$	Turn-off Delay Time		-	48	-	ns
$t_f$	Turn-off Fall Time		-	36	-	ns
<b>Drain-Source Diode Characteristics and Maximum Ratings</b>						
$I_S$	Maximum Continuous Drain to Source Diode Forward Current		-	-	6	A
$I_{SM}$	Maximum Pulsed Drain to Source Diode Forward Current		-	-	16	A
$V_{SD}$	Drain to Source Diode Forward Voltage	$V_{GS}=0V, I_S=4A$	-	-	1.2	V

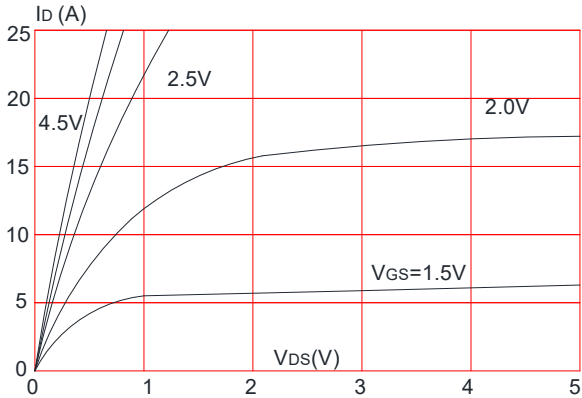
Notes: 1. Repetitive Rating: Pulse Width Limited by Maximum Junction Temperature

2. Pulse Test: Pulse Width  $\leq 300\mu s$ , Duty Cycle  $\leq 0.5\%$

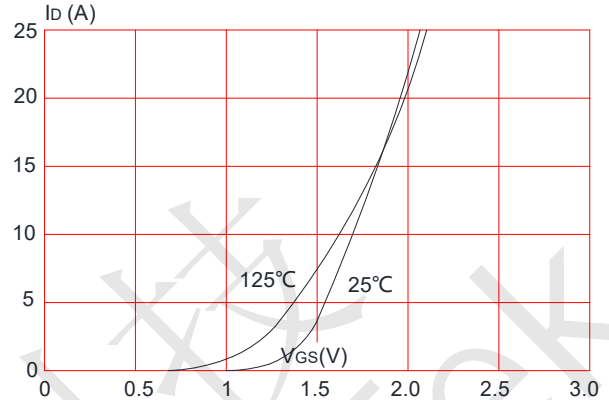


## CST2300L Typical Performance Characteristics

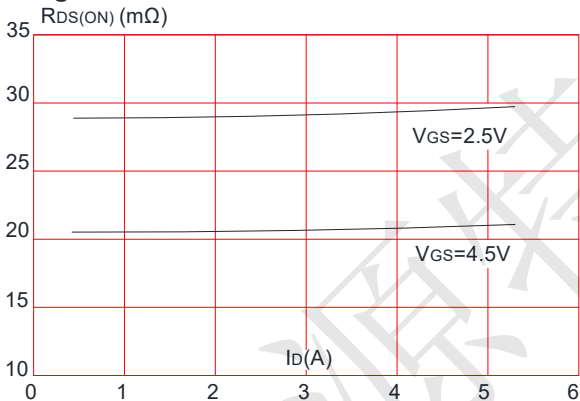
**Figure 1:** Output Characteristics



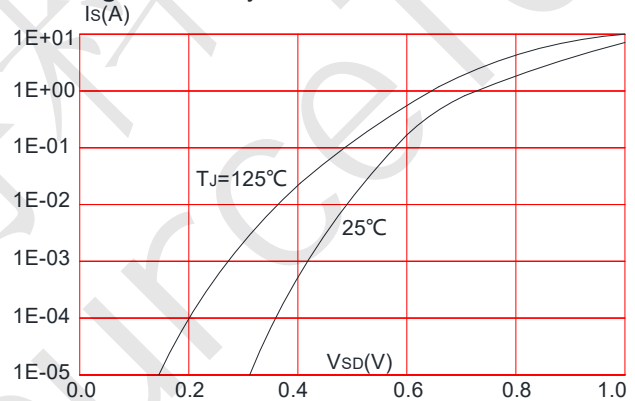
**Figure 2:** Typical Transfer Characteristics



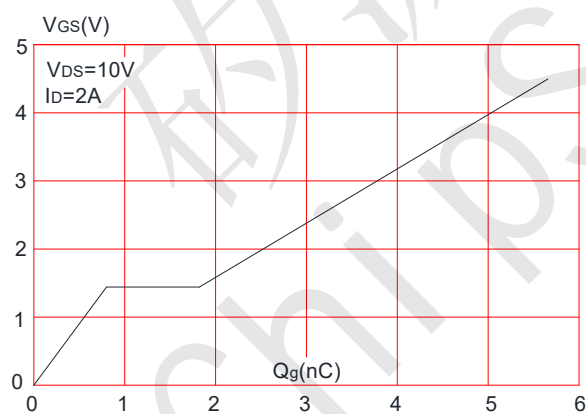
**Figure 3:** On-resistance vs. Drain Current



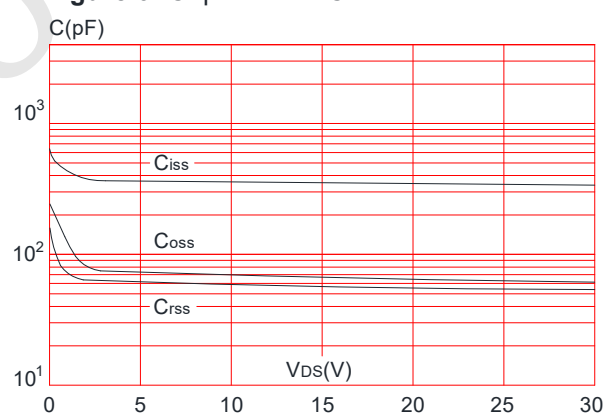
**Figure 4:** Body Diode Characteristics



**Figure 5:** Gate Charge Characteristics



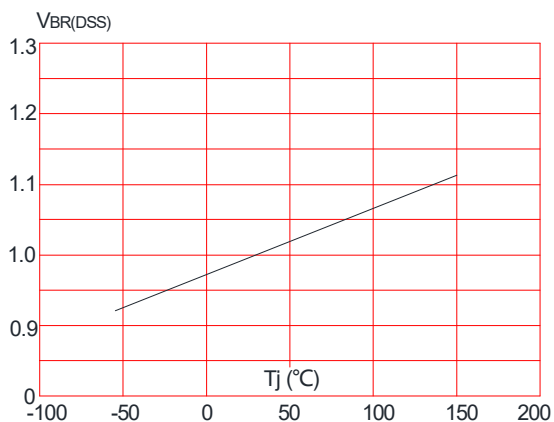
**Figure 6:** Capacitance Characteristics



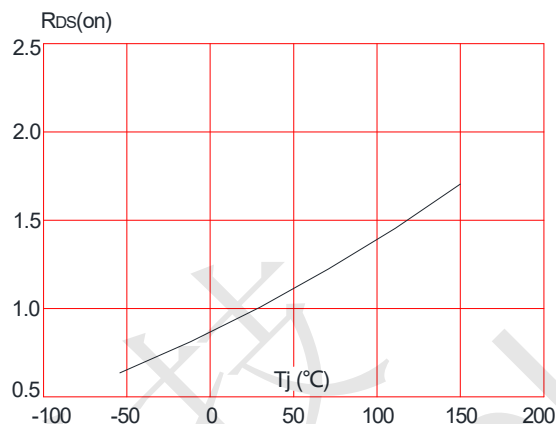


### CST2300L N-Ch 20V Fast Switching MOSFETs

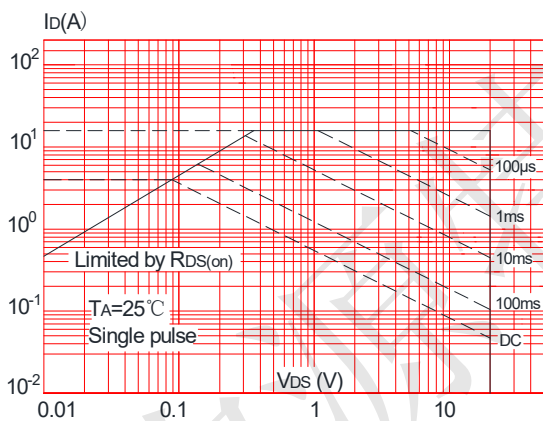
**Figure 7:** Normalized Breakdown Voltage vs. Junction Temperature



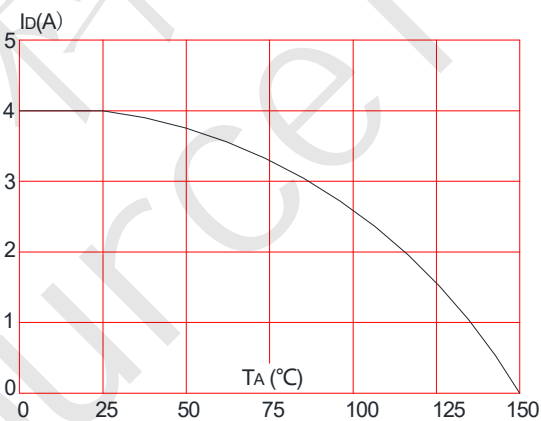
**Figure 8:** Normalized on Resistance vs. Junction Temperature



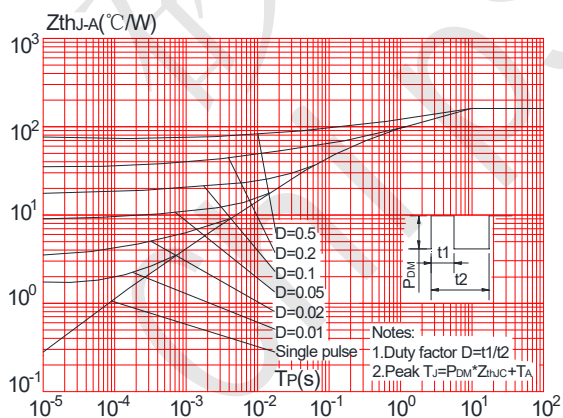
**Figure 9:** Maximum Safe Operating Area



**Figure 10:** Maximum Continuous Drain Current vs. Ambient Temperature

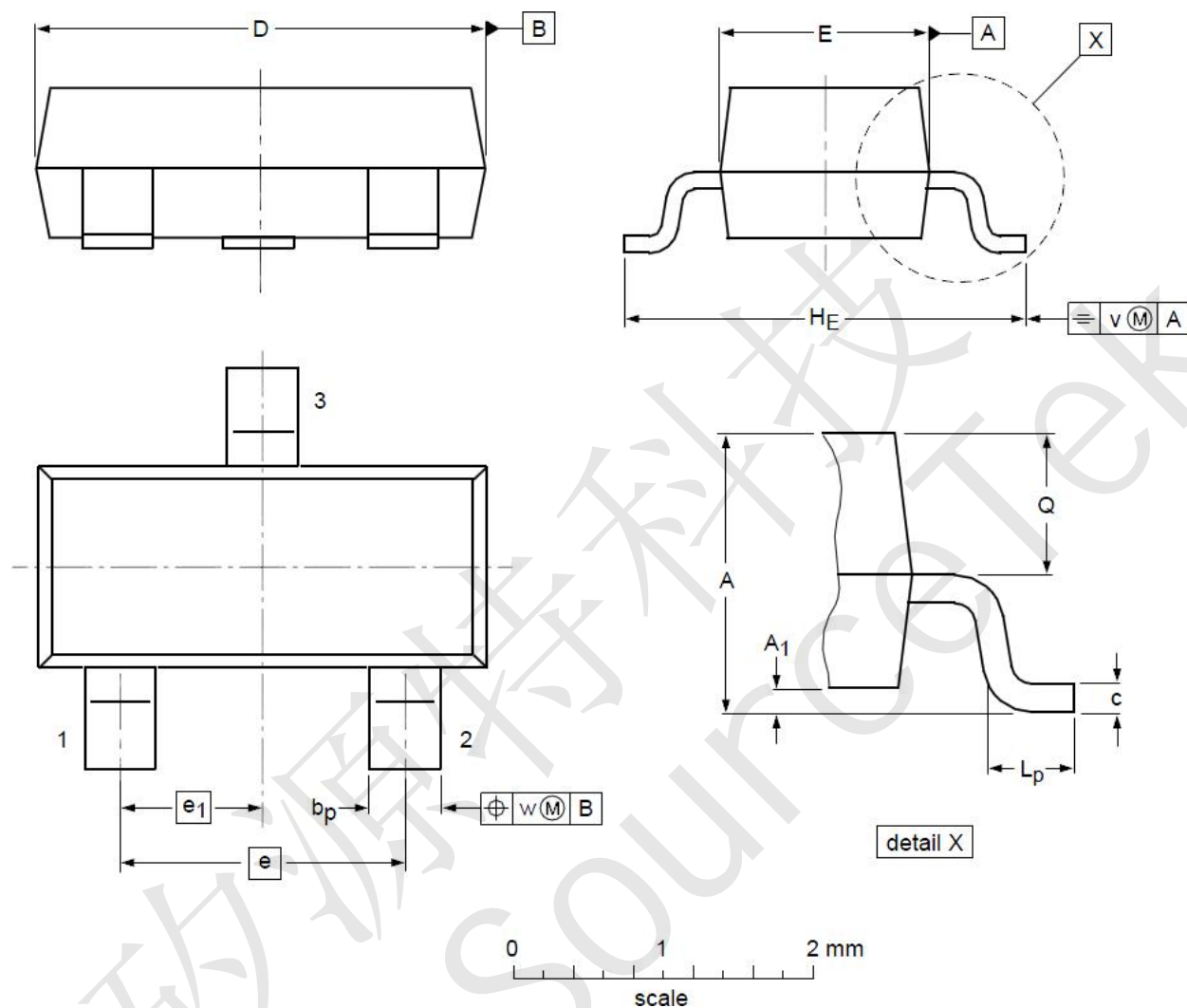


**Figure 11:** Maximum Effective Transient Thermal Impedance, Junction-to-Ambient





#### CST2300L Package Mechanical Data-SOT-23-3L



Symbol	Dimensions In Millimeters		Dimensions In Inches	
	Min	Max	Min	Max
A	1.050	1.250	0.041	0.049
A1	0.000	0.100	0.000	0.004
A2	1.050	1.150	0.041	0.045
b	0.300	0.500	0.012	0.020
c	0.100	0.200	0.004	0.008
D	2.820	3.020	0.111	0.119
E	1.500	1.700	0.059	0.067
E1	2.650	2.950	0.104	0.116
e	0.950(BSC)		0.037(BSC)	
e1	1.800	2.000	0.071	0.079
L	0.300	0.600	0.012	0.024
$\theta$	0°	8°	0°	8°