



### CST20G10F N-Ch and P-Ch Fast Switching MOSFETs



- ★ Super Low Gate Charge
- ★ 100% EAS Guaranteed
- ★ Green Device Available
- ★ Excellent CdV/dt effect decline
- ★ Advanced high cell density Trench technology

#### CST20G10F Product Summary

BVDSS	RDSON	ID
100V	70mΩ	15.0A
-100V	180mΩ	-7.0A

#### CST20G10F Description

The CST20G10F is the highest performance complementary N-ch and P-ch MOSFETs with extreme high cell density, which provide excellent RDSON and gate charge for most of the synchronous buck converter applications.

The CST20G10F meet the RoHS and Green Product requirement, 100% EAS guaranteed with full function reliability approved.

#### CST20G10F PDFN5060-8L Pin Configuration

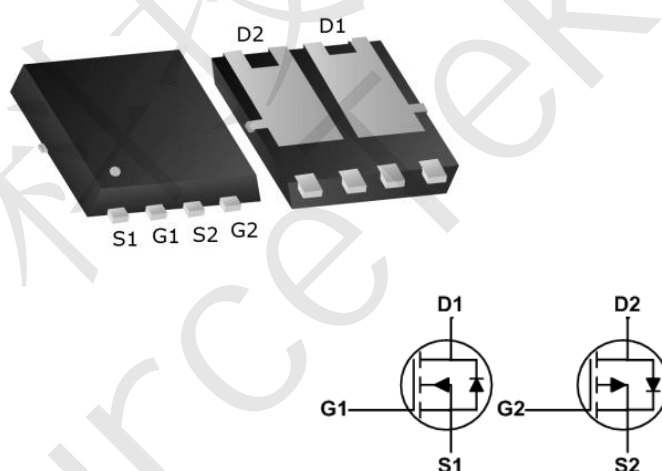

#### CST20G10F Absolute Maximum Ratings

Symbol	Parameter	Rating		Units
		N-Channel	P-Channel	
$V_{DS}$	Drain-Source Voltage	100	-100	V
$V_{GS}$	Gate-Source Voltage	±20	±20	V
$I_D@T_A=25^\circ\text{C}$	Continuous Drain Current, $V_{GS}@10\text{V}^1$	15.0	-7.0	A
$I_D@T_A=70^\circ\text{C}$	Continuous Drain Current, $V_{GS}@10\text{V}^1$	10.0	-4.5	A
$I_{DM}$	Pulsed Drain Current <sup>2</sup>	25	-9.5	A
EAS	Single Pulse Avalanche Energy <sup>3</sup>	22.5	35.3	mJ
$I_{AS}$	Avalanche Current	22.6	-26.6	A
$P_D@T_A=25^\circ\text{C}$	Total Power Dissipation <sup>4</sup>	3.5	3.5	W
$T_{STG}$	Storage Temperature Range	-55 to 150	-55 to 150	°C
$T_J$	Operating Junction Temperature Range	-55 to 150	-55 to 150	°C

#### CST20G10F Thermal Data

Symbol	Parameter	Typ.	Max.	Unit
$R_{\theta JA}$	Thermal Resistance Junction-Ambient <sup>1</sup>	---	75	°C/W
$R_{\theta JC}$	Thermal Resistance Junction-Case <sup>1</sup>	---	62.5	°C/W



### CST20G10F N-Ch and P-Ch Fast Switching MOSFETs

#### CST20G10F Electrical Characteristics (T<sub>J</sub> = 25°C, unless otherwise noted)

Parameter	Symbol	Test Conditions	Min.	Typ.	Max.	Unit	
<b>Static Characteristics</b>							
Drain-Source Breakdown Voltage	V <sub>(BR)DSS</sub>	V <sub>GS</sub> = 0V, I <sub>D</sub> = 250μA	100	-	-	V	
Gate-body Leakage current	I <sub>GSS</sub>	V <sub>DS</sub> = 0V, V <sub>GS</sub> = ±20V	-	-	±100	nA	
Zero Gate Voltage Drain Current	I <sub>DSS</sub>	V <sub>DS</sub> = 100V, V <sub>GS</sub> = 0V	T <sub>J</sub> = 25°C	-	-	1	μA
			T <sub>J</sub> = 100°C	-	-	100	
Gate-Threshold Voltage	V <sub>GS(th)</sub>	V <sub>DS</sub> = V <sub>GS</sub> , I <sub>D</sub> = 250μA	1.2	-	2.5	V	
Drain-Source on-Resistance <sup>4</sup>	R <sub>DS(on)</sub>	V <sub>GS</sub> = 10V, I <sub>D</sub> = 5A	-	65	90	mΩ	
		V <sub>GS</sub> = 4.5V, I <sub>D</sub> = 3A	-	75	105		
Forward Transconductance <sup>4</sup>	g <sub>fs</sub>	V <sub>DS</sub> = 5V, I <sub>D</sub> = 5A	-	12	-	S	
<b>Dynamic Characteristics<sup>5</sup></b>							
Input Capacitance	C <sub>iss</sub>	V <sub>DS</sub> = 15V, V <sub>GS</sub> = 0V, f = 1MHz	-	1220	-	pF	
Output Capacitance	C <sub>oss</sub>		-	53	-		
Reverse Transfer Capacitance	C <sub>rss</sub>		-	42	-		
Gate Resistance	R <sub>g</sub>	f = 1MHz	-	1.3	-	Ω	
<b>Switching Characteristics<sup>5</sup></b>							
Total Gate Charge	Q <sub>g</sub>	V <sub>GS</sub> = 10V, V <sub>DS</sub> = 50V, I <sub>D</sub> = 5A	-	20.6	-	nC	
Gate-Source Charge	Q <sub>gs</sub>		-	4	-		
Gate-Drain Charge	Q <sub>gd</sub>		-	3.7	-		
Turn-On Delay Time	t <sub>d(on)</sub>	V <sub>GS</sub> = 10V, V <sub>DD</sub> = 50V, R <sub>G</sub> = 3Ω, I <sub>D</sub> = 5A	-	4.7	-	ns	
Rise Time	t <sub>r</sub>		-	21	-		
Turn-Off Delay Time	t <sub>d(off)</sub>		-	20	-		
Fall Time	t <sub>f</sub>		-	16	-		
<b>Drain-Source Body Diode Characteristics</b>							
Diode Forward Voltage <sup>4</sup>	V <sub>SD</sub>	I <sub>S</sub> = 1A, V <sub>GS</sub> = 0V	-	-	1.2	V	
Continuous Source Current	I <sub>S</sub>	T <sub>C</sub> = 25°C	-	-	15	A	

#### Notes:

1. Repetitive rating, pulse width limited by junction temperature T<sub>J(MAX)</sub> = 150°C.
2. The data tested by pulsed, pulse width ≤ 300μs, duty cycle ≤ 2%
3. The EAS data shows Max. rating. The test condition is V<sub>DD</sub> = 25V, V<sub>GS</sub> = 10V, L = 0.1mH, I<sub>AS</sub> = 8A
4. The power dissipation is limited by 150°C junction temperature
5. The data is theoretically the same as I<sub>D</sub> and I<sub>DM</sub>, in real applications, should be limited by total power dissipation.



### CST20G10F N-Ch and P-Ch Fast Switching MOSFETs

#### CST20G10F P-Channel Electrical Characteristics (T<sub>J</sub>=25 °C, unless otherwise noted)

Symbol	Parameter	Conditions	Min.	Typ.	Max.	Unit
BV <sub>DSS</sub>	Drain-Source Breakdown Voltage	V <sub>GS</sub> =0V, I <sub>D</sub> =-250uA	-100	---	---	V
R <sub>DS(ON)</sub>	Static Drain-Source On-Resistance <sup>2</sup>	V <sub>GS</sub> =-10V, I <sub>D</sub> =-3A	---	180	220	mΩ
		V <sub>GS</sub> =-4.5V, I <sub>D</sub> =-2A	---	210	255	
V <sub>GS(th)</sub>	Gate Threshold Voltage	V <sub>GS</sub> =V <sub>DS</sub> , I <sub>D</sub> =-250uA	-1.2	---	-2.5	V
I <sub>DSS</sub>	Drain-Source Leakage Current	V <sub>DS</sub> =-80V, V <sub>GS</sub> =0V, T <sub>J</sub> =25°C	---	---	-1	uA
		V <sub>DS</sub> =-80V, V <sub>GS</sub> =0V, T <sub>J</sub> =85°C	---	---	-30	
I <sub>GSS</sub>	Gate-Source Leakage Current	V <sub>GS</sub> =±20V, V <sub>DS</sub> =0V	---	---	±100	nA
R <sub>g</sub>	Gate Resistance	V <sub>DS</sub> =0V, V <sub>GS</sub> =0V, f=1MHz	---	13	---	Ω
Q <sub>g</sub>	Total Gate Charge (-10V)	V <sub>DS</sub> =-50V, V <sub>GS</sub> =-10V, I <sub>D</sub> =-2A	---	19	---	nC
Q <sub>gs</sub>	Gate-Source Charge		---	3.4	---	
Q <sub>gd</sub>	Gate-Drain Charge		---	2.9	---	
T <sub>d(on)</sub>	Turn-On Delay Time	V <sub>DD</sub> =-30V, V <sub>GS</sub> =-10V, R <sub>G</sub> =3.3Ω, I <sub>D</sub> =-1A	---	9	---	ns
T <sub>r</sub>	Rise Time		---	6	---	
T <sub>d(off)</sub>	Turn-Off Delay Time		---	39	---	
T <sub>f</sub>	Fall Time		---	33	---	
C <sub>iss</sub>	Input Capacitance	V <sub>DS</sub> =-30V, V <sub>GS</sub> =0V, f=1MHz	---	1228	---	pF
C <sub>oss</sub>	Output Capacitance		---	41	---	
C <sub>rss</sub>	Reverse Transfer Capacitance		---	29	---	

#### CST20G10F Diode Characteristics

Symbol	Parameter	Conditions	Min.	Typ.	Max.	Unit
I <sub>S</sub>	Continuous Source Current <sup>1,5</sup>	V <sub>G</sub> =V <sub>D</sub> =0V, Force Current	---	---	-7.0	A
V <sub>SD</sub>	Diode Forward Voltage <sup>2</sup>	V <sub>GS</sub> =0V, I <sub>S</sub> =-1A, T <sub>J</sub> =25°C	---	---	-1.2	V

Note :

- 1.The data tested by surface mounted on a 1 inch<sup>2</sup> FR-4 board with 2OZ copper.
- 2.The data tested by pulsed, pulse width ≤ 300us, duty cycle ≤ 2%
- 3.The EAS data shows Max. rating. The test condition is V<sub>DD</sub>=-25V, V<sub>GS</sub>=-10V, L=0.5mH, I<sub>AS</sub>=-14A
- 4.The power dissipation is limited by 150°C junction temperature
- 5.The data is theoretically the same as I<sub>D</sub> and I<sub>DM</sub>, in real applications, should be limited by total power dissipation.



#### CST20G10F N-Channel Typical Characteristics

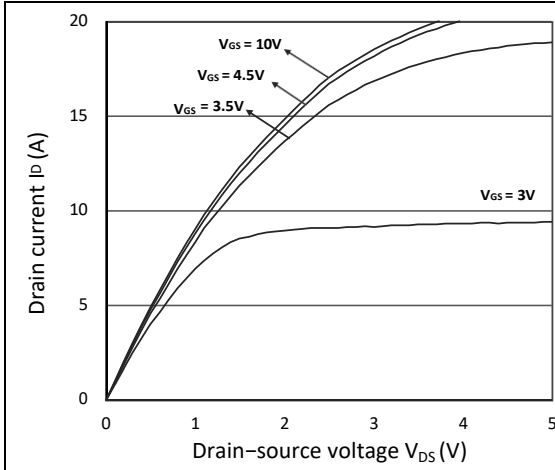

Figure 1. Output Characteristics

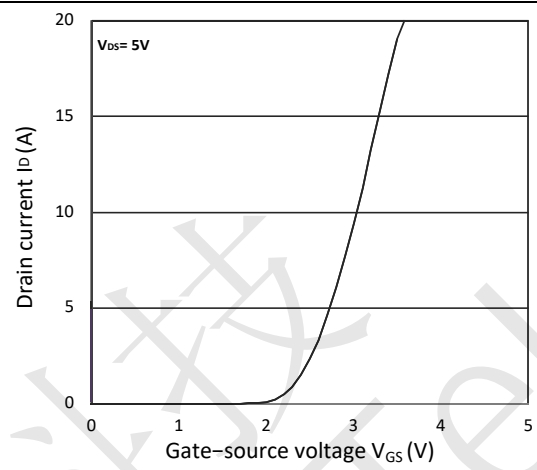

Figure 2. Transfer Characteristics

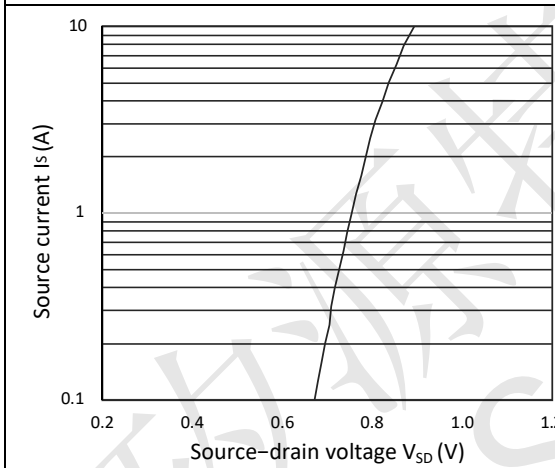

Figure 3. Forward Characteristics of Reverse

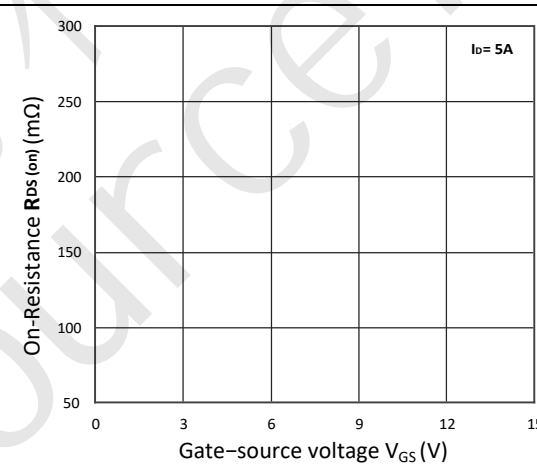

Figure 4.  $R_{DS(on)}$  vs.  $V_{GS}$

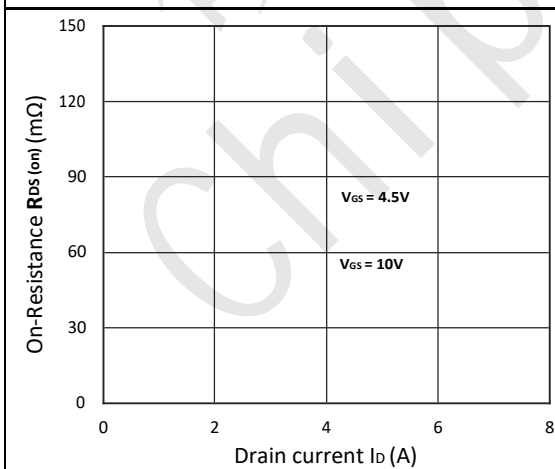

Figure 5.  $R_{DS(on)}$  vs.  $I_D$

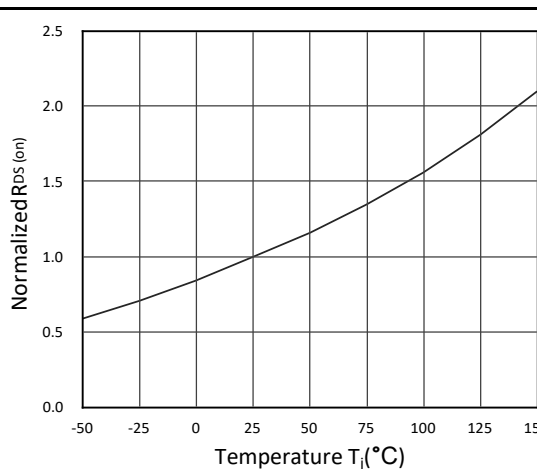

Figure 6. Normalized  $R_{DS(on)}$  vs. Temperature



### CST20G10F N-Ch and P-Ch Fast Switching MOSFETs

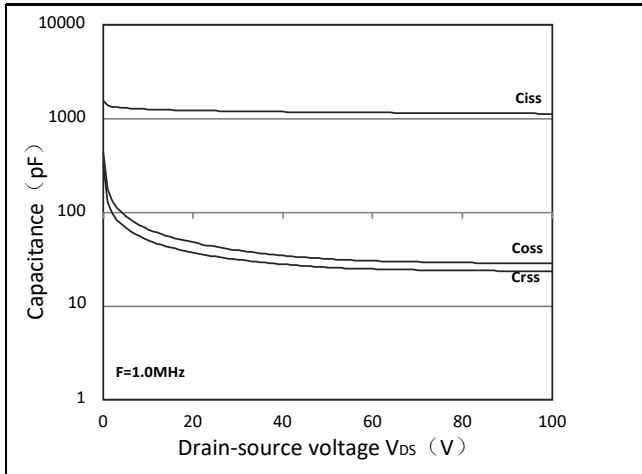

Figure 7. Capacitance Characteristics

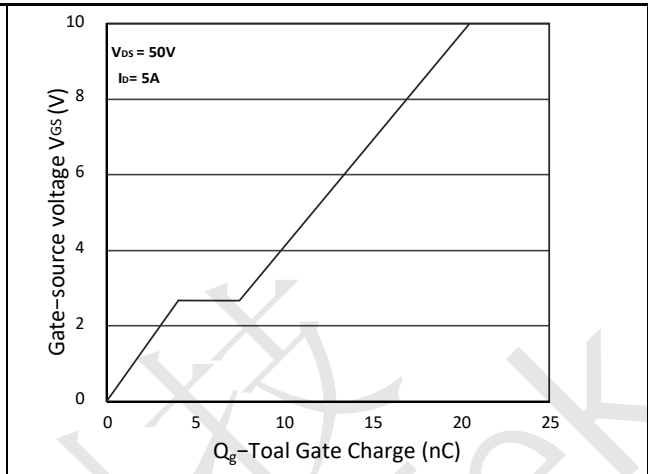

Figure 8. Gate Charge Characteristics

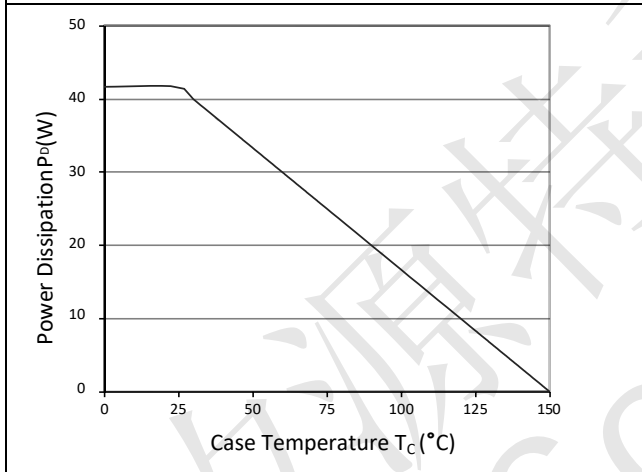

Figure 9. Power Dissipation

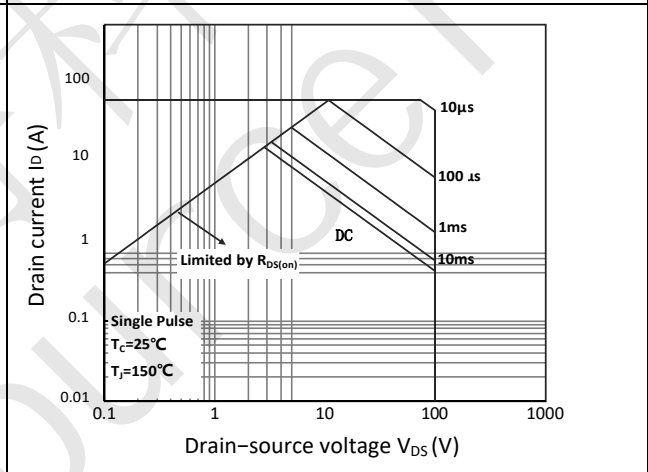

Figure 10. Safe Operating Area

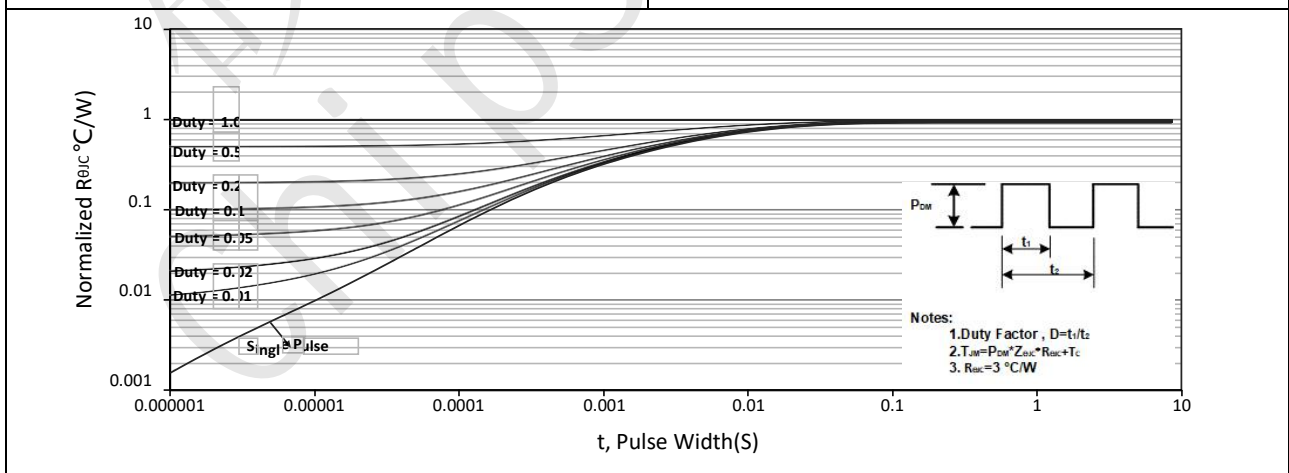

Figure 11. Normalized Maximum Transient Thermal Impedance



### CST20G10F N-Ch and P-Ch Fast Switching MOSFETs

#### CST20G10F P-Channel Typical Characteristics

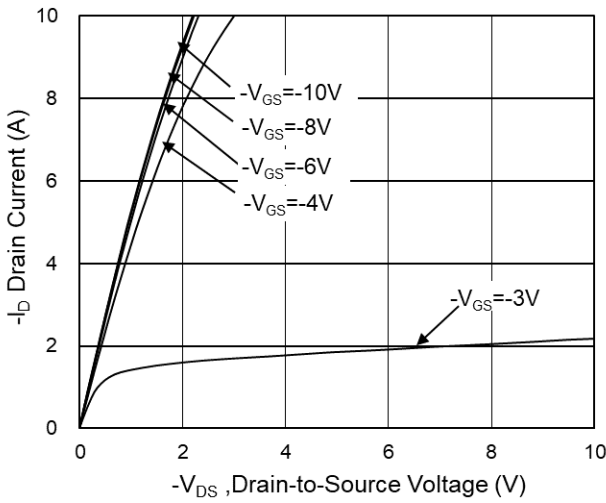

Fig.1 Typical Output Characteristics

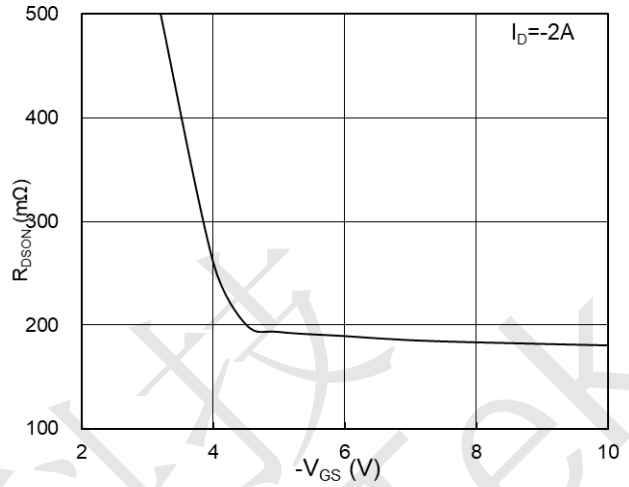

Fig.2 On-Resistance vs G-S Voltage

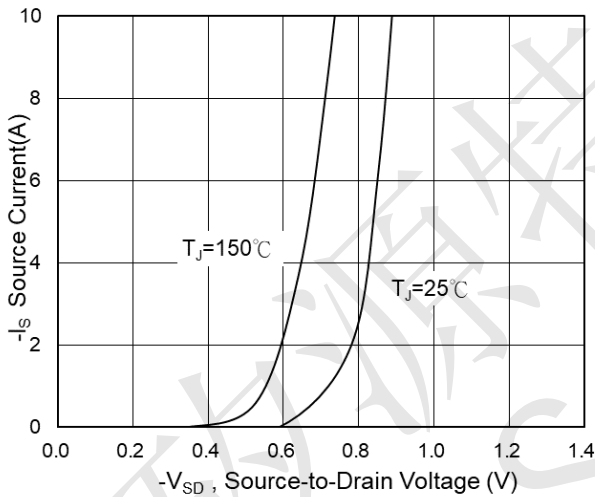

Fig.3 Source Drain Forward Characteristics

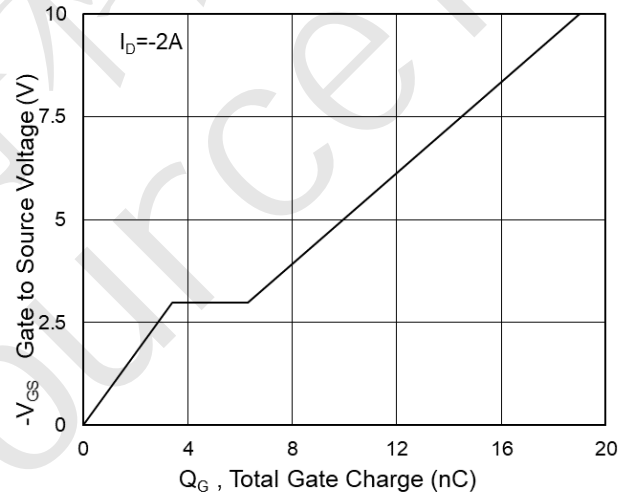

Fig.4 Gate-Charge Characteristics

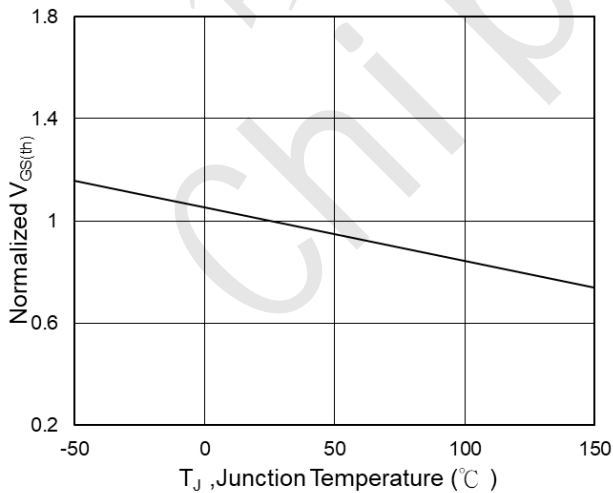

Fig.5 Normalized  $V_{GS(th)}$  vs  $T_J$

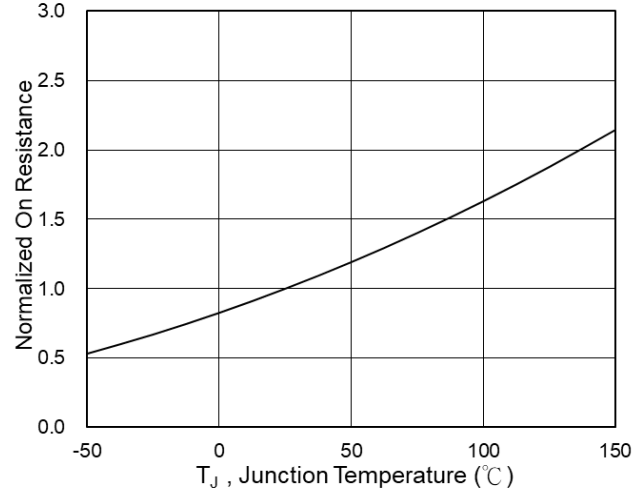

Fig.6 Normalized  $R_{DS(on)}$  vs  $T_J$



### CST20G10F N-Ch and P-Ch Fast Switching MOSFETs

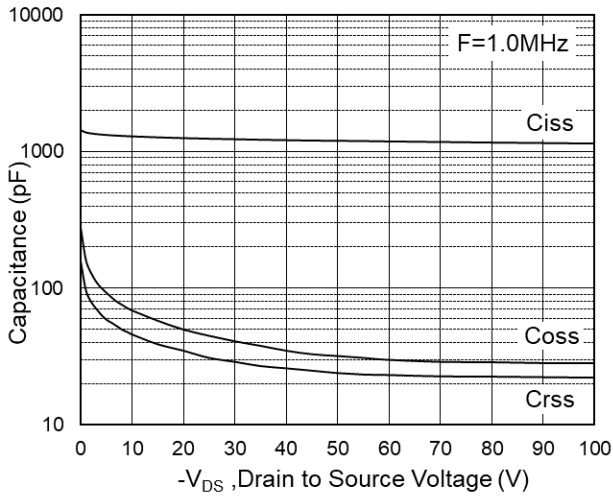

Fig.7 Capacitance

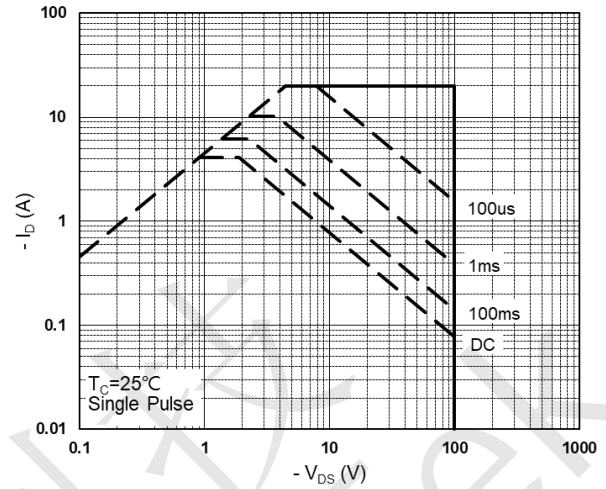

Fig.8 Safe Operating Area

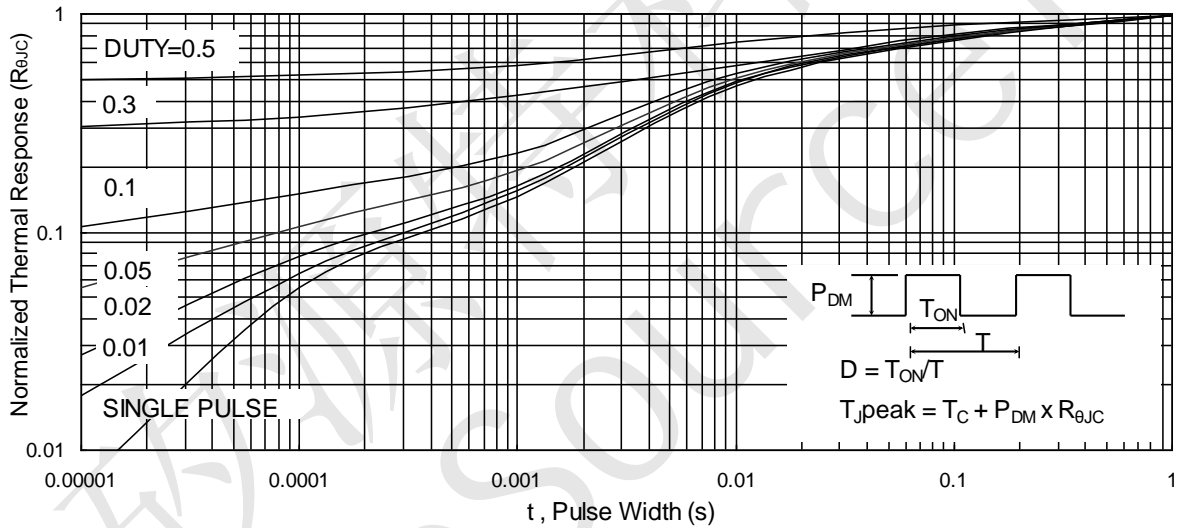

Fig.9 Normalized Maximum Transient Thermal Impedance

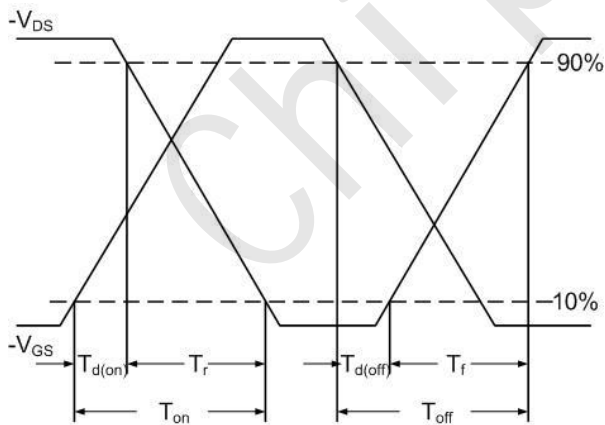

Fig.10 Switching Time Waveform

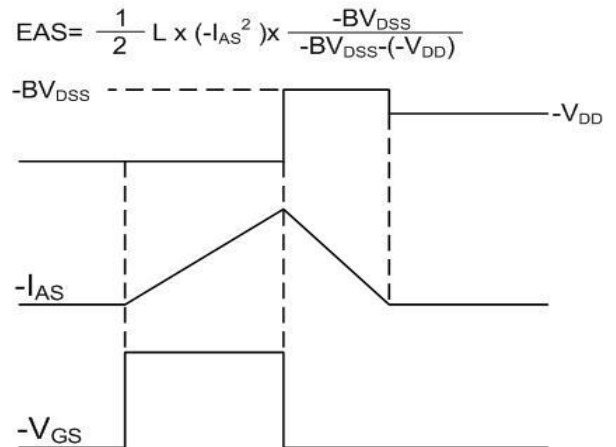
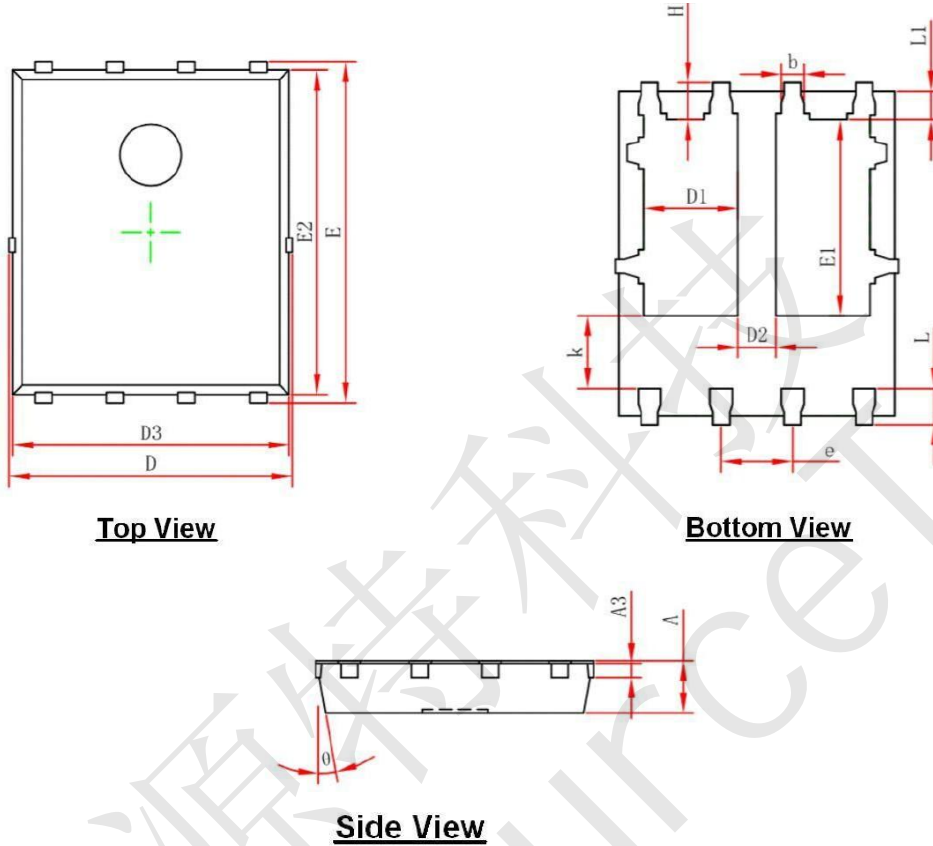

Fig.11 Unclamped Inductive Waveform



#### CST20G10F Package Mechanical Data- PDFN5060-8L



Symbol	Dimensions In Millimeters		Dimensions In Inches	
	Min.	Max.	Min.	Max.
A	0.900	1.000	0.035	0.039
A3	0.154REF.		0.006REF.	
D	4.944	5.096	0.195	0.201
E	5.974	6.126	0.235	0.241
D1	1.470	1.870	0.058	0.074
D2	0.470	0.870	0.019	0.034
E1	3.375	3.575	0.133	0.141
D3	4.824	4.976	0.190	0.196
E2	5.674	5.826	0.223	0.229
k	1.190	1.390	0.047	0.055
b	0.350	0.450	0.014	0.018
e	1.270TYP.		0.050TYP.	
L	0.559	0.711	0.022	0.028
L1	0.424	0.576	0.017	0.023
H	0.574	0.726	0.023	0.029
$\theta$	10°	12°	10°	12°